

DORMER  PRAMET

**RAILWAY
INDUSTRY
SOLUTIONS**

2022



 **DORMER**

 **PRAMET**



7		INTRODUCTION & ASSORTMENT HIGHLIGHTS
13	RAILWAY INDUSTRY	PRODUCTION OF NEW RAILWAY WHEELS
20		RAILWAY WHEEL RECONDITIONING
26		AXLES MACHINING
30		STATIONARY & DYNAMIC RAIL MILLING
37		TURNOUTS MACHINING
57		BASE PLATES MACHINING
63		WAGON & BOGIE PARTS MACHINING
73		TURNING ASSORTMENT
92	POSITIVE INSERTS	
129	NEGATIVE INSERTS	
248	MILLING ASSORTMENT	SOLID HM & HSS MILLS
269		ROTARY BURRS
289		INDEXABLE MILLS
433	HOLEMAKING ASSORTMENT	SOLID CARBIDE & HSS DRILLS
456		REAMERS & COUNTERSINKS
477		EXCHANGEABLE HEAD INDEXABLE DRILLS
533	THEARDING ASSORTMENT	MATERIAL SPECIFIC & HSS TAPS
548		TECHNICAL PART



INDEXABLE TOOLS – CONTENT (ALPHABETICAL)

PRODUCT FAMILY		PRODUCT FAMILY		PRODUCT FAMILY		PRODUCT FAMILY	
8		DKT(RL)-C	162, 188	KTP-LFN(RL)	194	S-DKT(RL)5556	166, 192
802D	516		213	KTP-SAN(RL)	218		217
803D	518	DKT(RL)-D	163, 189	KTP-SFN(RL)	219	SHN06C	301
804D	521		214	M		SHN09C	305
805D	523	DVJN(RL) EXT	226	MVJN(RL) EXT	228	SLN12	333
C		DVPN(RL) EXT	227	MWLN(RL) EXT	241	SLN16	339
C.-DCLN(RL) EXT	155	DWLN(RL) EXT	239	P		SPN13	309
C.-DDJN(RL) EXT	181	F		PCBN(RL) EXT	151	SRC16	378
C.-DDNNN EXT	182	FSB22X	313	PCLN(RL) EXT	153	SRC20	382
C.-DVJN(RL) EXT	229	J		PDJN(RL) EXT	179	SRD12	386
C.-DWLN(RL) EXT	243	J(T)-SAD11E	344	PDNN(RL) EXT	180	SRD16	391
C.-SRDCN EXT	107	J(T)-SAD16E	349	PRDCN EXT	102	SRDCN EXT	104
C.-SVHB(RL) EXT	126	J(T)-SLSN	356	PRSC(RL) EXT	103	SRSC(RL) EXT	105
C.-SVJB(RL) EXT	127	J(T)-SSAP	360	PSBN(RL) EXT	206	SVHB(C)(RL) EXT	120
C.-SVVBN EXT	128	J(T)-SXP16	410	PWLN(RL) EXT	242	SVJB(C)(RL) EXT	121
D		K		S		SVPB(C)(RL) EXT	123
DCBN(RL) EXT	147	KHP-CBN(RL)	157	S90CN(XN)	372	SVVB(C)N EXT	124
DCLN(RL) EXT	149	KHP-CLN(RL)	158	S90SN	366	SVXB(C)(RL) EXT	125
DDJN(RL) EXT	178	KHP-RSC(RL)	108	SAD11E	317	SZD07	397
DKH(RL)	109, 159	KHP-SBN(RL)	208	SAD16E	325	SZD09	401
	210	KHP-SSN(RL)	209	S-DKT(RL)4065X	190, 215	SZD12	405
DKT(RL)-A	160, 186	KTP-CAN(RL)	167	S-DKT(RL)4065X+KTP	165		
	211	KTP-CFN(RL)	168	S-DKT(RL)4065X-C	164		
DKT(RL)-B	161, 187	KTP-LAN(RL)	193	S-DKT(RL)4065X-S	191, 216		
	212						



SOLID ROUND TOOLS – CONTENT (ALPHABETICAL)

PRODUCT FAMILY		PRODUCT FAMILY		PRODUCT FAMILY		PRODUCT FAMILY	
A		B956	470	G570	472	P811	282
A117	441	C		H		P815	283
A124	443	C135	259	H851	494	P819	284
A160	444	C700	261	H8512	501	P821	285
A166	445	C825	260	H853	496	R457	450
A730	446	E		H855	498	R950	488
A777	448	E102	542	H858	500	R960	490
B		E256	543	H860	502	R970	492
B100	462	E258	544	H861	503	S	
B161	464	E261	545	P		S710	255
B180	465	E334	546	P803	278	S812HA	256
B400	467	E335	547	P805	279	S822	257
B411	468	G		P807	280	S922	258
B955	469	G138	471	P809	281		



PRODUCT FAMILY		PRODUCT FAMILY		PRODUCT FAMILY		PRODUCT FAMILY	
(B		RCMT 16		SPET 12	
(S-)CN.. 08 – 15	416	BNMX 20	131		379		362
(S-)LC 16 – 32	427	C		RCMT 20	383	SPET 12 AD	362
(S-)LC 32	428	CNHQ	374	RCMX	99	SPEW 12 AD	363
(S-)LDEX 12; 13 (CEMR)	419	CNMG	134	RCUM	101	S-RNEX 15	429
(S-)LNE. 13; 15 (RE)	416	CNMM	143	RDGT 12	388	S-RNEX 16	429
(S-)LPGX 27	425	CNMX 19	145	RDGT 16	393	S-RPGN 20	427
(S-)SN.. 12; 15 (CEMR)	418	D		RDHX 12	387	S-SPEN 12	426
(S-)SN.. 12; 15 (CHW)	414	DNMG	170	RDHX 16	392	S-SPEN 12; 15	426
(S-)SN.. 12; 15 (RE)	416	DNMM	177	RDMT 12	388	T	
(S-)SN.. 12; 16 (CEMR)	420	H		RDMT 16	393	TNMM	221
(S-)SN.. 15 (CEMR)	417	HNGX 06	302	RDMX 12	387	TU 14	221
(S-)SN../(S-)LNEQ 12; 15 (RE)	417	HNGX 09	306	RDMX 16	392	V	
(S-)SN.Q 15	424	L		RNGX 12	428	VBMT	113
(S-)SNE. 12 – 15 (RE)	414	LN.X 19, LN.X 30	184	ROEX 15	429	VCGT	116
(S-)SNE. 12; 15 (KCH)	415	LNE 434	415	RPUX	111	VCMT	118
(S-)SNEX 13 – 27	422	LNET 16	357	S		VNMG	223
(S-)SP.W 14 – 19	425	LNGU 12	336	SBKX 22	314	W	
(S-)SP.X 12 – 27	423	LNGU 16	341	SBMR 22	314	WNMG	231
(S-)XOEX 12	418	LNGX 12	334	S-CDEW 11/(S-)XDE. 12 – 16	419	WNMM	238
5		LNMT	185	SCET	514	X	
513000; LNEQ 28	415	LNMU 16	340	S-LNEX 15	424	XNGX 06	303
A		O		SNET 13	358	XNGX 09	307
ADEX 11-HF	321, 347	OPCN 06	94	SNEX 13; 15 (CEMR)	421	XNGX 13	311
ADEX 16	328, 352	P		SNGX 13	357	XNHQ	374
ADEX 16-HF	329, 352	PNMQ 13	310	SNHQ AZ	368	XPET	515
ADMX 11	319, 345	PNMU 13	310	SNHQ TRL	369	XPHT 16	411
ADMX 16	326, 350	R		SNMG	197	Z	
APET 15	361	RCMH	96	SNMM	201	ZDCW 07	398
APEW 15	361	RCMT	97	SNMX 19	204	ZDCW 09	402
				SNXN 13	421	ZDEW 12	406



DORMER PRAMET

DELIVERING THE FAB FOUR

We have revamped our general metric product catalogues, featuring more than **20,000** cutting tools. The four publications cover the main application categories – holemaking, milling, turning and threading. Download your copy today!

Simply Reliable.





7		INTRODUCTION & ASSORTMENT HIGHLIGHTS
13	RAILWAY INDUSTRY	PRODUCTION OF NEW RAILWAY WHEELS
20		RAILWAY WHEEL RECONDITIONING
26		AXLES MACHINING
30		STATIONARY & DYNAMIC RAIL MILLING
37		TURNOUTS MACHINING
57		BASE PLATES MACHINING
63		WAGON & BOGIE PARTS MACHINING
73		TURNING ASSORTMENT
92	POSITIVE INSERTS	
129	NEGATIVE INSERTS	
248	MILLING ASSORTMENT	SOLID HM & HSS MILLS
269		ROTARY BURRS
289		INDEXABLE MILLS
433	HOLEMAKING ASSORTMENT	SOLID CARBIDE & HSS DRILLS
456		REAMERS & COUNTERSINKS
477		EXCHANGEABLE HEAD INDEXABLE DRILLS
533	THEARDING ASSORTMENT	MATERIAL SPECIFIC & HSS TAPS
548		TECHNICAL PART



DORMER PRAMET

FOLLOW US



SHARE



LIKE



COMMENT



TAG



RE-TWEET





INTRODUCTION

Dormer Pramet has more than 100 years of experience in the cutting tool industry. It has been several decades since we developed our first product for the railway segment. Since then, we have added many to our portfolio and we are constantly innovating to meet customer needs.

The railway industry requires a variety of different components that are machined in many ways. Having the right cutting tools is paramount. Dormer Pramet offer numerous standard and tailor-made turning tools for machining railway wheels and axles as well as milling and drilling tools for machining rails, turnouts, base plates and wagon parts.

This catalogue brings you the selection of tools, their usage recommendations and other tips that will help you increase your productivity, performance and reliability



With the many different workpiece materials and variety of sizes requiring several machining operations, this program of diverse cutting tools demonstrates Dormer Pramet's commitment to the railway segment, with further additions planned in the coming years.

For more information on Dormer Pramet's complete product range, please visit www.dormerpramet.com or contact your local sales office.



New wheels machining

Dormer Pramet is offering a comprehensive range of round inserts in sizes RCMX 16, 20, 25, 30 and 32 with chip-breakers suitable for roughing to finishing of forged train and locomotive wheels.

You can choose from high performance CVD grades for areas P10 up to P35 that are suitable for hard and soft wheels machining with usage of high feeds and speeds.

Besides the standard tools we can also offer specials in terms of inserts as well as of holders with specific back-ends.



Axles machining

Dormer Pramet offers standard assortment of roughing and finishing turning tools. Large, negative inserts with chip-breakers are suitable for high material removal where rigidity of inserts is vital. On the other hand, smaller positive inserts with sharp geometry are used for achieving a fine surface quality.

Among the standard assortment of solid drills, indexable drills, Hydra drills and taps, we can also offer special tailor-made variants.



Re-turning of wheels

Dormer Pramet offers a complete line of tools for wheel re-turning. Holders for Hegenscheidt, Rafamet and other machine tools are equipped with exchangeable cartridges with protective cemented carbide shims.

Our insert geometries and grades can satisfy all customer needs. Inserts LNMX 19, LNMX 30, SNMX 19 and CNMX 19 with chipbreakers RR, RM ensure high material removal, whereas RF, TF make a perfect surface.

Inserts LNMX 30, LNMT 31 and TNMN are suitable for very high material removal rate with maximum depth of cut up to 15 mm.

ROEX 15 and RNGX 12 inserts for renovation of wheels by milling make our offer complete.





Dynamic rail milling

The all-in-one space and money saving design of milling cutters for machining of rails, these cutters consist of universal basic body for left and right spindles and easily interchangeable cartridges that each contains 11 indexable inserts.

Cutters are available in \varnothing 290 mm, \varnothing 600 mm and \varnothing 900 mm.

Cutting profile is defined by the cartridges and indexable inserts and can be used for machining of rail profiles 60E1, 60E2, 54E5, 54E1, 46E3 and others upon request.

High reliability of the cutting process is ensured by usage of rigid tangential inserts with 8 and 4 cutting edges and by usage of PVD grade that has a durability up to 3.5 km per cutting edge.



Switches



We are able to satisfy the needs of machining any material the switches are made of. Our experience in switch assembly machining can be demonstrated by one simple figure: during our history we have produced and delivered more than 400 types of cutters for machining of the rail head, web, base and grooves of most common rail profiles like 60E1, 60E2, 54E1 and others.

Our cutters are developed with maximum productivity in mind as well as maximum operational reliability. Therefore, most of the cutters are designed with tangential inserts that are also very economical due to the high number of cutting edges.

We also offer a variety of very productive standard tools like “Penta HD” face milling cutter or high-performance replaceable head drill – “Hydra”.

Wagon parts

Dormer Pramet offers a wide range of standard and special tools for machining of a large variety of wagon parts like carriage body, side frames, bolsters, bearing houses, couplings and other parts. We can satisfy all customer's needs in case of face milling, square shoulder milling, HFC milling, indexable and solid round tools drilling and in many more applications.

The comprehensive tailor-made range of technology we offer for the machining of couplers is an example of our capabilities in the wagon production segment.

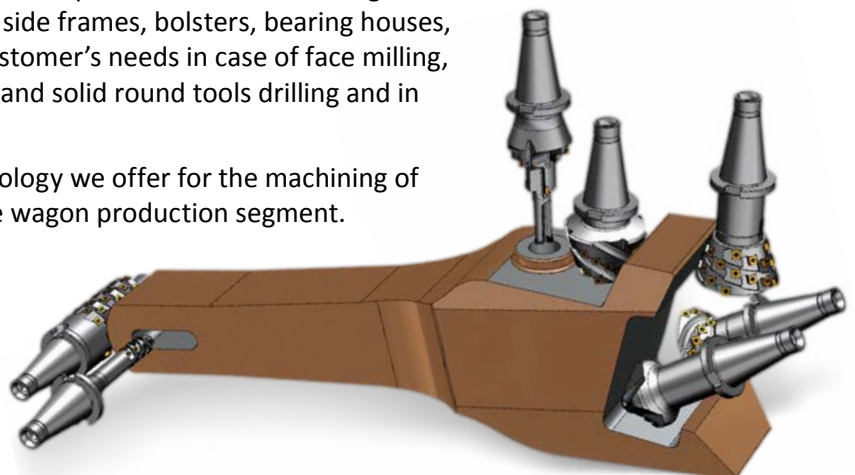



**RAILWAY
INDUSTRY**



**CONTENT**

7		INTRODUCTION & ASSORTMENT HIGHLIGHTS
13	RAILWAY INDUSTRY	PRODUCTION OF NEW RAILWAY WHEELS
20		RAILWAY WHEEL RECONDITIONING
26		AXLES MACHINING
30		STATIONARY & DYNAMIC RAIL MILLING
37		TURNOUTS MACHINING
57		BASE PLATES MACHINING
63		WAGON & BOGIE PARTS MACHINING
73		TURNING ASSORTMENT
92	POSITIVE INSERTS	
129	NEGATIVE INSERTS	
248	MILLING ASSORTMENT	SOLID HM & HSS MILLS
269		ROTARY BURRS
289		INDEXABLE MILLS
433	HOLEMAKING ASSORTMENT	SOLID CARBIDE & HSS DRILLS
456		REAMERS & COUNTERSINKS
477		EXCHANGEABLE HEAD INDEXABLE DRILLS
533	THEARDING ASSORTMENT	MATERIAL SPECIFIC & HSS TAPS
548		TECHNICAL PART



DORMER PRAMET



POCKET SAVER

Our machining calculator allows you to measure the savings based on different products and applications. A useful pocket-sized tool, which will help keep cash in your pockets! **Simply Reliable.**

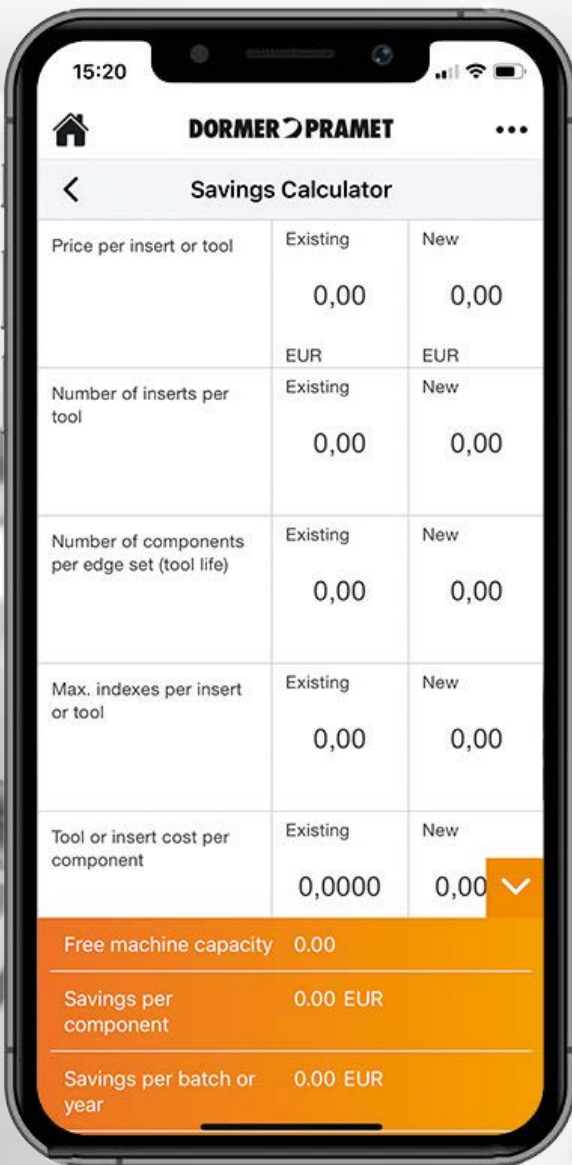



PRODUCTION OF NEW RAILWAY WHEELS

RAILWAY WHEELS

Railway wheels are the only pieces that contact the rails, and have the biggest impact on train efficiency. Therefore, a high demand on wheel surface quality is needed. Roughness and shape precision has a major significance for forces, wear behavior, friction and vibrations.

In the contact zone between railway wheel and rail the surfaces and bulk material must be strong enough to resist the normal (vertical) forces introduced by heavy loads and the dynamic response induced by track and wheel irregularities. The tangential forces in the contact zone must be low enough to allow moving heavy loads with little resistance, at the same time the tangential loads must be high enough to provide traction, braking, and steering of the trains.

Wear occurs in the contact if wheels are poorly lubricated due to sliding that is typical of wheel-rail contact. The friction between the wheels and rail is extremely important as it plays a major role in the wheel-rail interface process such as adhesion, wear, rolling contact fatigue, and noise generation. Effective control of friction through the application of friction modifiers to the wheel-rail contact is therefore clearly advantageous, although the process must be carefully managed. The aim of friction management is to maintain friction levels in the wheel-rail contact to give.

Railway operations also generate vibrations that are transmitted through the ground into neighboring properties. These can lead either to feel able vibration (in the range 4 to 80 Hz) or to low frequency rumbling noise (30 to 250 Hz). Vibrations are also transmitted into the vehicle itself, affecting passenger comfort. The most important mechanical noise source from a train is generated at the wheel-rail contact. Rolling noise is caused by vibrations of the wheel and track structures, induced at the wheel-rail contact point by vertical irregularities in the wheel and rail surfaces.



Dormer Pramet has longtime experience with machining of railway wheels. We aim to meet the most demanding requirements in terms of quality, reliability and productivity.

Nowadays, we cooperate with dozen of factories around the world with a total annual production more than 8 million wheels. We also deliver high quality level of technical service.

Machining of railway wheels is very specific technology, which is based on the principle of copying the shape by round cutting edge. One of the main issues is determining the optimal chip thickness with respect to force balance, heat distribution as well as to ideal chip breaking. Dormer Pramet gives you optimal and economic solution for your production.

Middle chip thickness

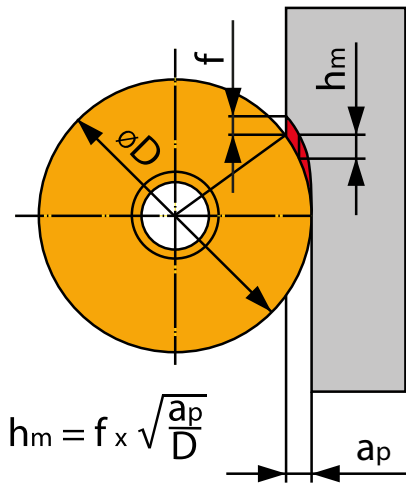

NOMENCLATURE

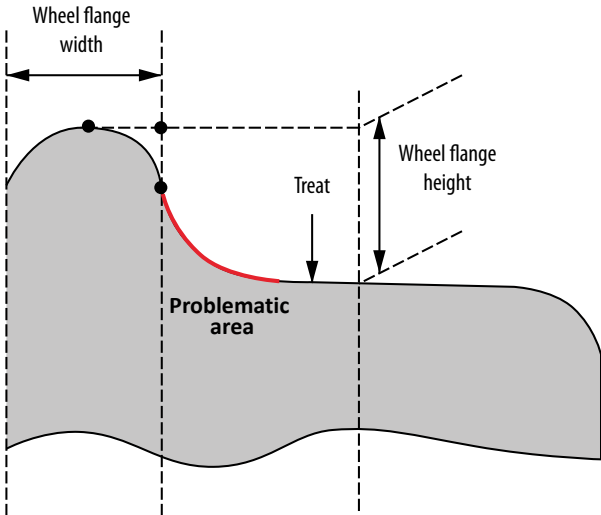

We can offer:

- Reliable cutting process
- Lifetime and productivity
- Optimal chip breaking
- Dimension accuracy and stability
- Surface quality
- Continuous development

Recommended middle chip thickness

Insert	Chipbreaker	hm
RCMX 32	000108	0.400
RCMT, RCMX 16	37	0.375
RCMX 25	37	0.425
RCMX 16	331	0.225
RCMX 20	341	0.250
RCMX 25	351	0.350
RCMX 32	361	0.450
RCMT 20	371	0.400
RCMT 25	372	0.450
RCMX 20	RF1	0.225
RCMX 25	RF1	0.275
RCMX 20	RM1	0.250
RCMX 25	RM1	0.350
RCMX 25	RM2	0.425
RCMX, RCMH 32	RM2	0.450
RCMT 16	RM3	0.350
RCMT 25	RM3	0.400
RCMX 28	RR2	0.450
RCMX, RCMH 32	RR2	0.450
RCMT 30	RR4	0.450
RCUM 30	RR7	0.450

The most problematic area of the machining process is in the radius between the treat and the flange. Round inserts need to cope with higher forces and needs to remove more material because almost the whole ¼ of the insert is wrapped by the workpiece. We recommend decreasing the feed by 30 % in this area.

Influences to cutting process:

- Cutting conditions
- Geometry and micro-geometry
- Cutting material
- Workpiece hardness (250 – 340 HB)
- Cooling
- Machine power and rigidity



CHIPBREAKER RECOMMENDATIONS

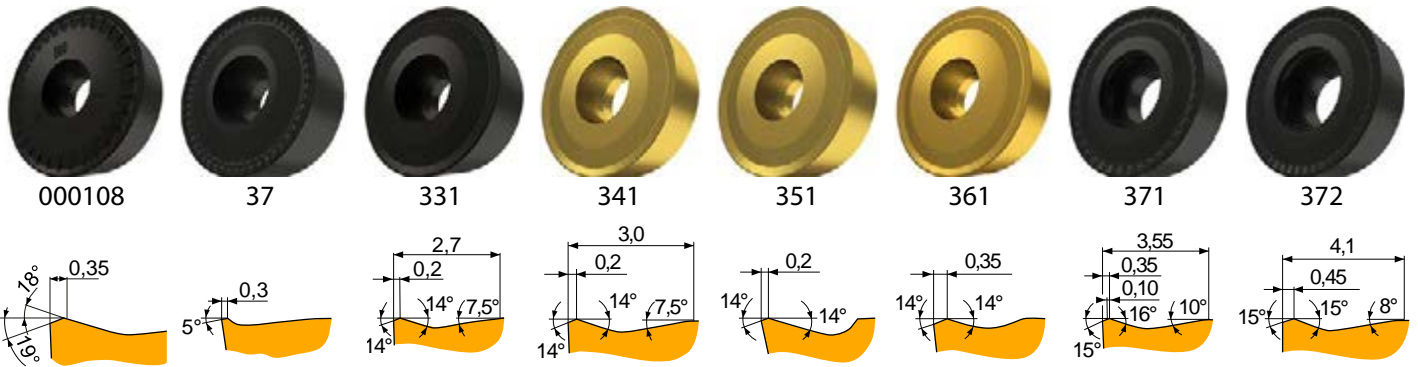

000108

- Chip-breaker for semi-rough to rough machining, and continuous to interrupted cuts.
- For depth of cuts from 2 mm to 8 mm and feeds from 0.8 mm/rev. to 1.6 mm/rev.
- Available on insert RCMX 3209MO

37

- Chip-breaker for semi-rough to heavy-rough machining, and continuous to interrupted cuts.
- For depth of cuts from 0.5 mm to 6 mm and feeds from 0.4 mm/rev. to 1.2 mm/rev.
- Available on inserts RCMT 1606MO, RCMX 1606MOS, RCMX 2006MO and RCMX 2507MO

331

- Chip-breaker suitable for semi-rough to heavy-rough machining, and continuous to interrupted cuts.
- For depth of cuts from 1 mm to 4 mm, feeds from 0.4 mm/rev. to 1.2 mm/rev.
- Available on insert RCMX 1606MOS

341

- Chip-breaker for semi-rough to heavy-rough machining, and continuous to interrupted cuts.
- For depth of cuts from 1 mm to 6 mm and higher feeds from 0.4 mm/rev. to 1.2 mm/rev.
- Available on insert RCMX 2006MO

351

- Chip-breaker suitable for semi-rough to heavy-rough machining, and continuous to interrupted cuts.
- For depth of cuts from 1 mm to 6 mm and feeds from 0.3 mm/rev. to 1.2 mm/rev.
- Available on insert RCMX 2507MO

361

- Chip-breaker suitable for rough to heavy-rough machining and continuous to heavy interrupted cuts.
- For depth of cuts from 3 mm to 8 mm and feeds from 0.8 mm/rev. to 1.6 mm/rev.
- Available on insert RCMX 3209MO

371

- Chip-breaker suitable for semi-rough to heavy-rough machining, and continuous to interrupted cuts.
- For depth of cuts from 1 mm to 5 mm and feeds from 0.2 mm/rev. to 1.2 mm/rev.
- Available on insert RCMT 2006MOS

372

- Chip-breaker for semi-rough to heavy-rough machining, continuous to interrupted cuts.
- For depth of cuts from 1 mm to 6 mm and feeds from 0.2 mm/rev. to 1.2 mm/rev.
- Available on insert RCMT 2507MOS

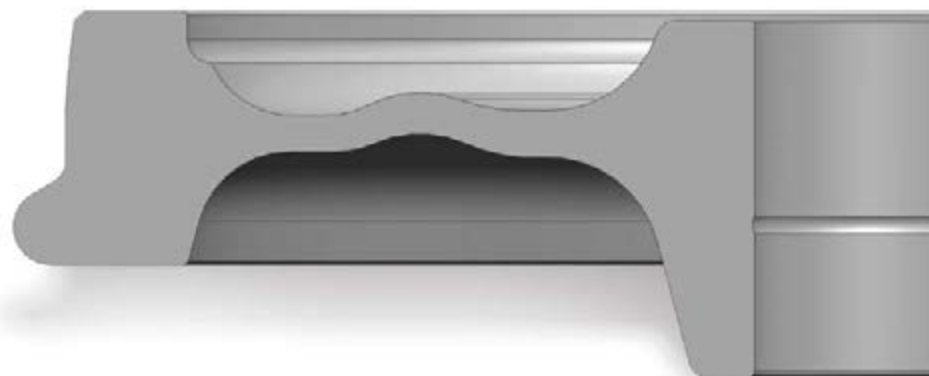



CHIPBREAKER RECOMMENDATIONS

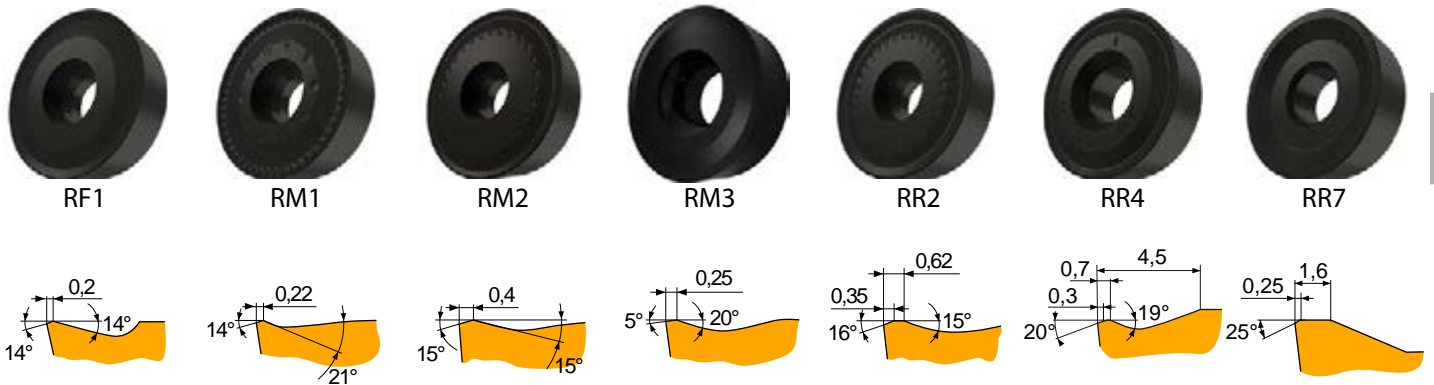

RF1

- **FIRST CHOICE** for finish machining
- Chip-breaker suitable for finish to semi-rough machining, and continuous to interrupted cuts.
- For depth of cuts from 1 mm to 7 mm and feeds from 0.45 mm/rev. to 1.25 mm/rev.
- Available on inserts RCMX 2006MO and RCMX 2507MO

RM1

- Chip-breaker for finish to rough machining, and continuous to interrupted cuts.
- For depth of cuts from 0.5 mm to 8 mm and feeds from 0.5 mm/rev. to 1.4 mm/rev.
- Available on inserts RCMX 2006MO, RCMX 2507MO

RM2

- **FIRST CHOICE** for semi-rough to rough machining
- Chip-breaker for semi-rough to rough machining, and continuous to interrupted cuts.
- For depth of cuts from 2 mm to 8 mm and feeds from 0.7 mm/rev. to 1.5 mm/rev.
- Available on inserts RCMH 3209MO, RCMX 2507MO and RCMX 3209MO

RM3

- Chip-breaker for semi-rough to rough machining, and continuous to interrupted cuts..
- For depth of cuts from 0.5 mm to 6 mm and feeds from 0.3 mm/rev. to 0.9 mm/rev.
- Available on inserts RCMT 1606MOE and RCMT 2507MOE

RR2

- **FIRST CHOICE** for rough to heavy-rough machining
- Chip-breaker for semi-rough to heavy-rough machining, and continuous to interrupted cuts.
- For depth of cuts from 4 mm to 8 mm and feeds from 0.8 mm/rev. to 1.6 mm/rev.
- Available on inserts S-RCMX 2809MO, RCMH 3209MO and RCMX 3209MO

RR4

- Chip-breaker for semi-rough to heavy rough machining, and continuous to interrupted cuts.
- For depth of cuts from 4 mm to 8 mm and feeds from 0.8 mm/rev. to 1.6 mm/rev.
- Available on inserts RCMT 3009MO, RCMT30-1438000

RR7

- Chip-breaker for heavy rough machining, and continuous to interrupted cuts.
- For depth of cuts from 4 mm to 8 mm and feeds from 0.8 mm/rev. to 1.6 mm/rev.
- Available on insert RCUM 3010MO

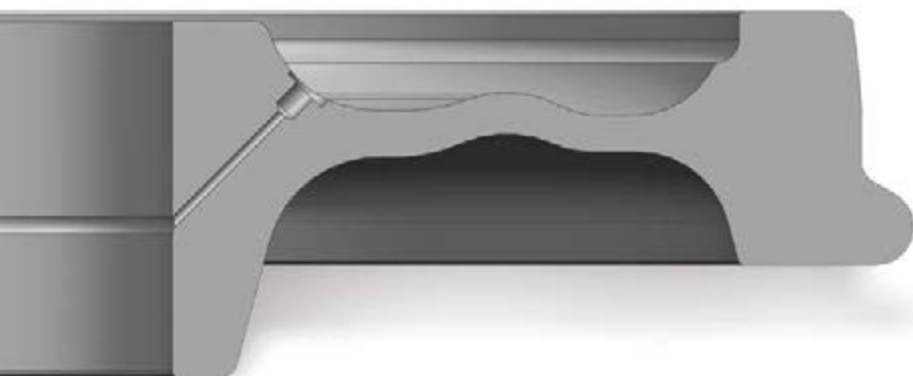



PRODUCTION PROCESS EXAMPLE

Example of the machining process for the new railway wheel on the vertical turning lathe. The process is done in several steps in two workpiece positions due to the fact that the wheel is machined from both sides. Two tools work at the same time to make the process more efficient. Roughing operations are done with insert RCMX 32 or RCMT 30, while the finishing operation is done with smaller insert sizes like RCMX 16, 20 or 25.

1. SETUP														
Step Nr.	Tool Nr.	Operation	Left tool					Tool Nr.	Operation	Right tool				
			ø D (mm)	Length (mm)	Vc (m/min)	n (1/min)	f (mm/rev)			ø D (mm)	Length (mm)	Vc (m/min)	n (1/min)	f (mm/rev)
1	T03	6-7, roughing ø 740-ø 515	628	198	90	46	1.8	T01	1-2, cutting ø 840-ø 730	800	92	115	46	1.2
2	T03	8-7, roughing ø 290-ø 515	403	198	110	87	1.8	T01	1-3, roughing	870	60	185	68	1.2
3	T04	6-7, finishing ø 740-ø 515	628	198	134	68	1.2	T02	1-3, finishing	870	60	237	87	1.2
4	T04	8-7, finishing ø 290-ø 515	403	198	168	133	1.2	T02	4-5, finishing ø 290-ø 190	240	60	100	133	1.2

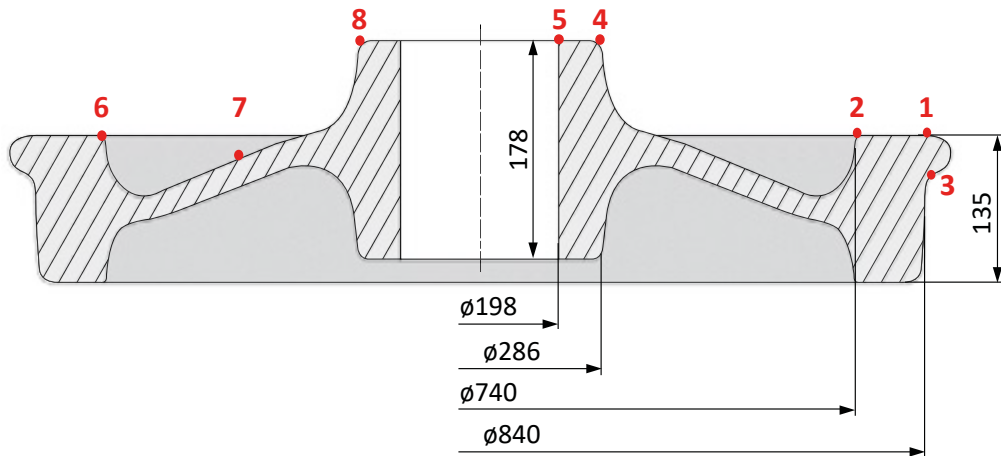

2. SETUP														
Step Nr.	Tool Nr.	Operation	Left tool					Tool Nr.	Operation	Right tool				
			ø D (mm)	Length (mm)	Vc (m/min)	n (1/min)	f (mm/rev)			ø D (mm)	Length (mm)	Vc (m/min)	n (1/min)	f (mm/rev)
1	T03	7-8, roughing ø 738-ø 513	626	162.5	90	46	1.8	T01	1-2, cutting ø 840-ø 740	790	60	115	46	1.2
2	T03	9-8, roughing ø 288-ø 513	401	162.5	60	48	1.8	T01	1-3, roughing	840	112	180	68	1.2
3	T04	7-8, finishing ø 738-ø 513	626	162.5	187	95	1.2	T02	1-3, finishing	840	112	250	95	1.2
4	T04	9-8, finishing ø 288-ø 513	401	162.5	167	133	1.2	T02	4-5, finishing ø 290-ø 190	240	60	100	133	1.2
								T05	5-6, roughing bore hole	197	188	80	129	1.2

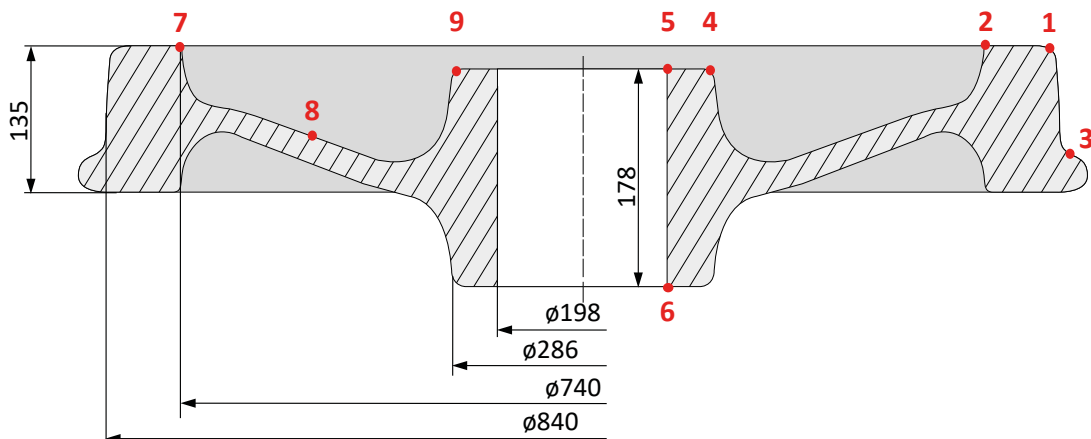



PRODUCTION PROCESS – TOOL LIST

Turning

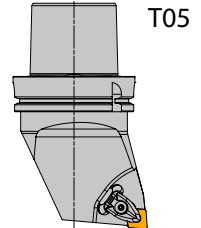
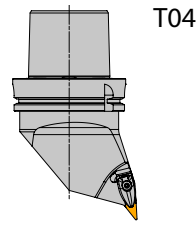
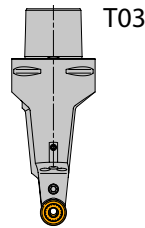
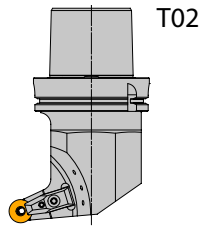
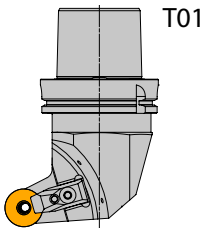

T01

- C10-DRGCL-K32
- Tool for roughing of wheel rim face, tread and the flange
- RCMX 3209MO

T03

- C10-PRDCN-K32
- Tool for roughing of the wheel center (both sides)
- RCMX 3209MO

T05

- C10-DCLNR-K16
- Tool for machining of the hub, bore hole
- CNMM 160616

T02

- C10-PRGCL-K20(25)
- Tool for finishing of the tread, flange and the hub face
- RCMX 2006MO (RCMX 2507MO)

T04

- C10-SVJCR-K16
- Tool for finishing of the wheel center
- VNMG 160408



Drilling & tapping



- PFX HSS-E (5 % Cobalt) Long Series Drill, AlcronaTop Coated
- High performance drill, able to produce high quality and accurate holes at high speeds and feeds (H10 hole tolerance). Self-centering 130° point angle and special parabolic flute design. Suitable for many materials. Alcrona-TOP coating improves performance and extends the tool life.



- FORCE X Solid Carbide 5XD Drill with Coolant Feed, TiAlN Coated



- PFX HSS-E (5 % Cobalt) Extra Long Series Drill (DIN 1869 Series 1), Bright Finish
- Recommended for drilling very deep holes or for applications where extra reach is needed. Specially designed parabolic flutes eliminate the need to drill deep holes in short steps (pecking).



- HSS-E-PM 15° Spiral Flute Machine Tap, Metric, DIN Standard
- Slow spiral flute tap for up to 1.5xD deep blind holes. With 15° helix for more stability threading in harder and higher strength steels. The reduced shank increases the reach of the tap.



Holders with capto back-end upon customer request.



RAILWAY WHEEL RECONDITIONING



RAILWAY WHEEL RECONDITIONING

Wheels are the most stressed components of railway vehicles. They carry axle loads of up to 25 tons and more. They guide the train on the tracks through curves and switches and are subjected to constant wear process. Once in a while a train wheel's profile must be renovated due to passengers' safety and comfort. All failures such as skid flats, scale, rust and rolling contact fatigue has to be removed.

Dormer Pramet offers a complete line of tools for wheel re-turning. Holders for Hegenscheidt, Rafamet and other machines are equipped with exchangeable cartridges with protective cemented carbide shim. Our insert geometries and grades can satisfy all customer needs. Inserts LNMX 19, LNMX 30, SNMX 19 and CNMX 19 with chipbreakers RR, RM ensure high material removal, whereas RF, TF make a perfect surface.

Main benefits:

- Exchangeable cartridges
- Cemented carbide shim
- High variety of insert shapes: CNMX, LNMX, LNMT, RNGX, ROEX, RPUX, SNMX, TNMN
- Chipbreakers for every cutting conditions: DF, DM, TF, TF1, TF2, RF, RM, RR, RR2
- Wide range of grades: T9310, T9315, T9325, T5305, T5315
- Rigid clamping by lever or excentre screw
- Easy insert or cartridge exchange





CHIPBREAKER RECOMMENDATIONS

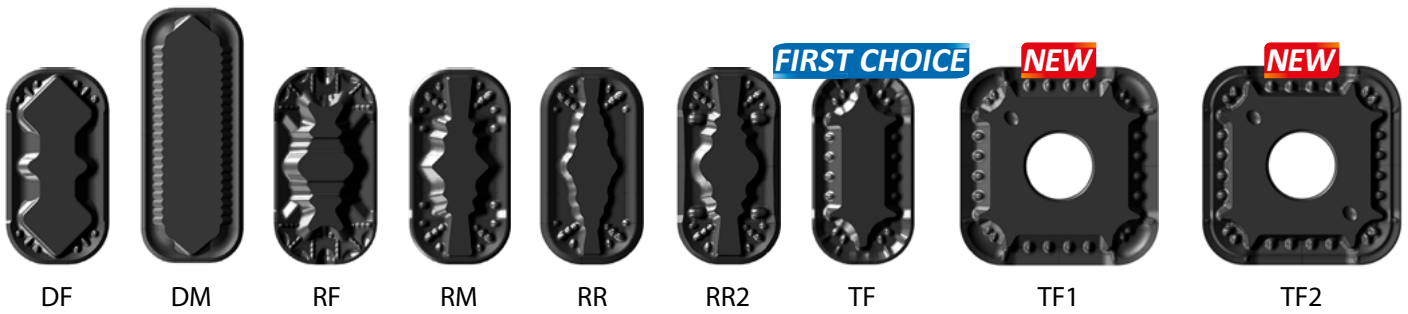

DF

- Chip-breaker for finishing and roughing operations
- For depth of cuts from 1 mm to 6 mm and higher feeds from 0.6 mm/rev. to 1.5 mm/rev.
- Optimum for lower to middle cutting speeds
- Available on insert LNMX 19

DM

- Chip-breaker for finishing and roughing operations
- For depth of cuts from 3 mm to 12 mm and higher feeds from 0.8 mm/rev. to 1.5 mm/rev.
- Optimum for lower to middle cutting speeds
- Available on insert LNMX 30

RF

- Chip-breaker suitable for finishing operations
- For depth of cuts from 2 mm to 8 mm, feeds from 0.4 mm/rev. to 1.1 mm/rev.
- Suitable for middle cutting speeds
- Available on inserts LNMX 19, LNMX 30, SNMX 19 and CNMX 19

RM

- Chip-breaker for finishing and roughing operations
- For depth of cuts from 2 mm to 10 mm and higher feeds from 0.45 mm/rev. to 1.8 mm/rev.
- Optimum for lower to middle cutting speeds
- Available on inserts LNMX 19 and LNMX 30

RR

- Chip-breaker suitable for roughing to heavy-roughing operations
- For depth of cuts from 2 mm to 12 mm and higher feeds from 0.75 mm/rev. to 1.8 mm/rev.
- Optimum for middle and higher cutting speeds
- Available on inserts LNMX 19 and LNMX 30

RR2

- Chip-breaker suitable for roughing to semi-roughing operations
- For depth of cuts from 2 mm to 6 mm and feeds from 0.6 mm/rev. to 1.8 mm/rev.
- Optimum for middle and higher cutting speeds
- Available on insert LNMX 19

TF

- **FIRST CHOICE**
- Versatile chip-breaker for finishing up to roughing operations
- Excellent chip flow
- For depth of cuts from 2 mm to 12 mm and feeds from 0.4 mm/rev. to 1.5 mm/rev.
- Optimum for middle cutting speeds
- Available on inserts LNMX 19, LNMX 30, SNMX 19 and CNMX 19

TF1

- **NEW DESIGN**
- Chip-breaker for finishing operations
- For small depth of cuts from 0.5 mm up to 7 mm
- used on S-SNMX 19 and S-CNMX 19

TF2

- **NEW DESIGN**
- Chip-breaker for finishing operations
- For small depth of cuts from 0.5 mm up to 7 mm
- used on S-SNMX 19 and S-CNMX 19



OTHER SOLUTIONS FOR WHEEL ROCONDITIONING



BNMX 201540

BNMX 201540

- Double sided insert with chip-breaker
- For depth of cuts from 2 mm to 10 mm and higher feeds from 0.6 mm/rev. to 1.5 mm/rev.



-

LNMT 311240 FIRST CHOICE



M

LNMT 311240

- Chip-breaker for finishing and roughing operations
- For depth of cuts from 4 mm to 15 mm and higher feeds from 0.5 mm/rev. to 1.5 mm/rev.

LNMT 311240-M

- **FIRST CHOICE**
- Chip-breaker suitable for finishing to heavy-roughing operations
- Very good chip-forming
- For depth of cuts from 2 mm to 15 mm and higher feeds from 0.5 mm/rev. to 1.5 mm/rev.



R

LNMT 311240-R

- Insert with a lower middle boss to reduce the cutting forces
- For depth of cuts from 4 mm to 15 mm and higher feeds from 0.5 mm/rev. to 1.5 mm/rev.



RPUX

RPUX

- Available versions: RPUX 3010MO and RPUX 2710MO
- Single sided round inserts with chip-breaker
- For depth of cuts from 2 mm to 7 mm and feeds from 0.6 mm/rev. to 1.2 mm/rev.
- Suitable for lower cutting speeds.



TNMN

TNMN

- Available in sizes TNMN 33 and TNMN 39
- Suitable for older machines
- Should be used together with separate chip-breaker TU14-2500612
- For depth of cuts from 2 mm to 10 mm, with higher feeds from 1.0 mm/rev. to 1.5 mm/rev.

TU14-2500612

- Chip-breaker for TNMN inserts



TU14-2500612



ROEX 15



RNGX 12



S-RNEX 15



S-RNEX 16

ROEX 15

- Insert for reconditioning of railway wheels by milling
- Single sided insert with square hole for proper fixing and easy indexing
- For depth of cuts up to 5 mm.

RNGX 12, RNEX 15 & RNEX 16

- Insert for reconditioning of railway wheels by milling
- Double sided insert
- For depth of cuts up to 5 mm.



WHEELS RE-TURNING ASSORTMENT - SPECIALS

EXAMPLE OF MACHINING – RE-TURNING OF RAILWAY WHEELS

1. RE-TURNING OF HARD WORN WHEEL 2 holders in machine

Holder description (2 cart.): DKTR 5555 X C2
Cartridge (right): KTP-LANR 30
Insert: LNMX 301940SN-RM, T93xx
Cartridge (left): KTP-LFNL 19
Insert: LNMX 191940SN-RM, T93xx
Holder description (1 cart.): DKTR 5555 X C1
Cartridge (right): KTP-LANR 30
Insert: LNMX 301940SN-TF, T93xx

Cutting conditions:

cutting speed: $v_c = 50 - 70$ m/min
feed per revolution: $f = 0.55 - 0.8$ mm/rev.
axial cutting depth: $a_p = 3 - 10$ mm

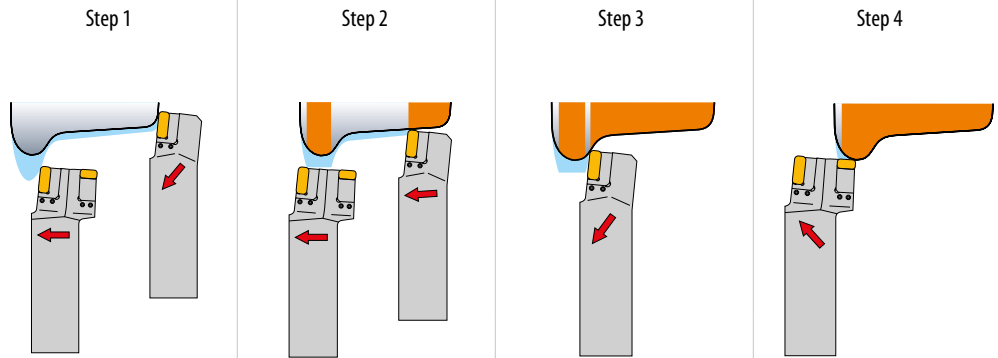

2. RE-TURNING OF HARD WORN WHEEL 1 holder in machine

Holder description (2 cart.): DKTR 5055 X A2
Cartridge (right): KTP-LANR 30
Insert: LNMX 301940SN-RM, T93xx
Cartridge (left): KTP-LFNL 19
Insert: LNMX 191940SN-RM, T93xx

Cutting conditions:

cutting speed: $v_c = 80 - 90$ m/min
feed per revolution: $f = 0.4 - 1.0$ mm/rev.
axial cutting depth: $a_p = 3 - 5$ mm

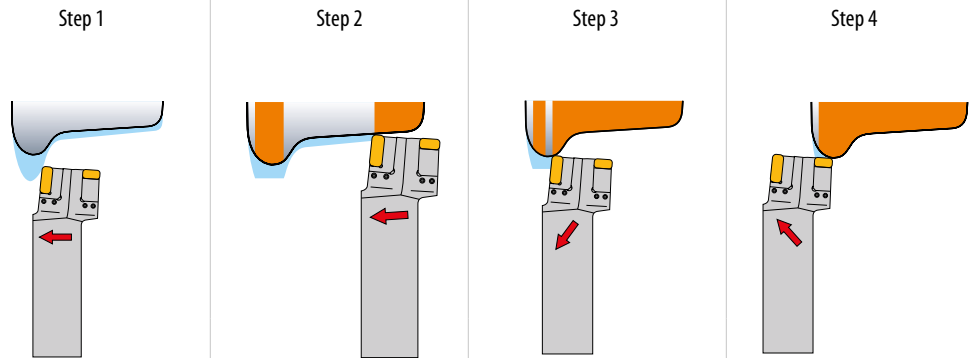

3. RE-TURNING OF LESS WORN WHEEL 1 holder in machine

Holder description (2 cart.): DKTR 5050 X D2
Cartridge (right): KTP-LANR 30
Insert: LNMX 301940SN-RF, T93xx
Cartridge (left): KTP-LFNL 19
Insert: LNMX 191940SN-RF, T93xx

Cutting conditions:

cutting speed: $v_c = 80 - 90$ m/min
feed per revolution: $f = 0.4 - 1.0$ mm/rev.
axial cutting depth: $a_p = 3 - 5$ mm

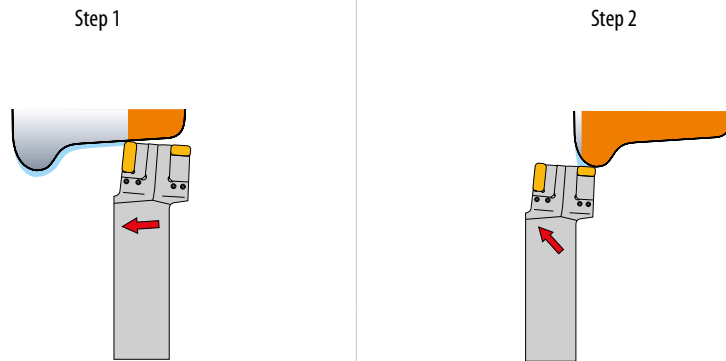

4. RE-TURNING OF WHEEL – 1ST PROFILE 1 holder in machine

Holder description (2 cart.): DKTR 5050 X D2
Cartridge (right): KTP-SANR 19
Insert: SNMX 191140SN-TF, T93xx
Cartridge (left): KTP-SFNL 19
Insert: SNMX 191140SN-TF, T93xx

Cutting conditions:

cutting speed: $v_c = 60 - 70$ m/min
feed per revolution: $f = 0.4 - 1.0$ mm/rev.
axial cutting depth: $a_p = 2 - 4$ mm

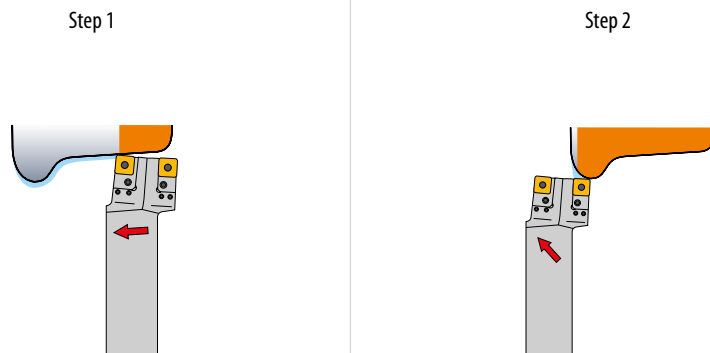



WHEELS RE-TURNING ASSORTMENT - SPECIALS

Tailor-made holders with several types of back-ends

Possibility of special types of holders according to customer request. Various types of back-ends like CAPTO, quadrates with longer overhang and atypical flanges that fits to customer's supports. All holder's pockets are compatible with standard Dormer Pramet cartridges for any kind of insert's shapes.

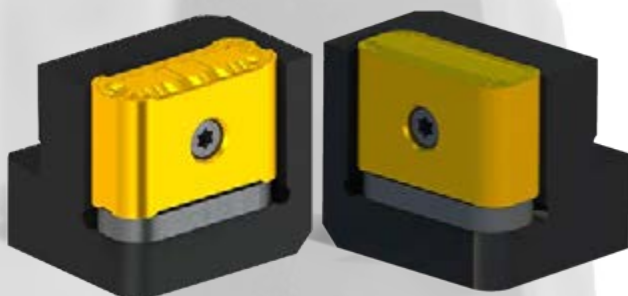
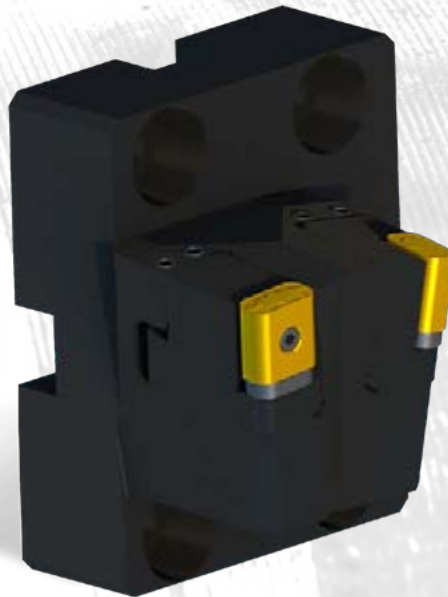

Special cartridges for LNMX 301940 tangential inserts

KTP-LAN(R)L 30... cartridges for turning of flanges with high depth of cuts. Cartridges are protected with cemented carbide shim. Inserts clamping by eccentric screw.

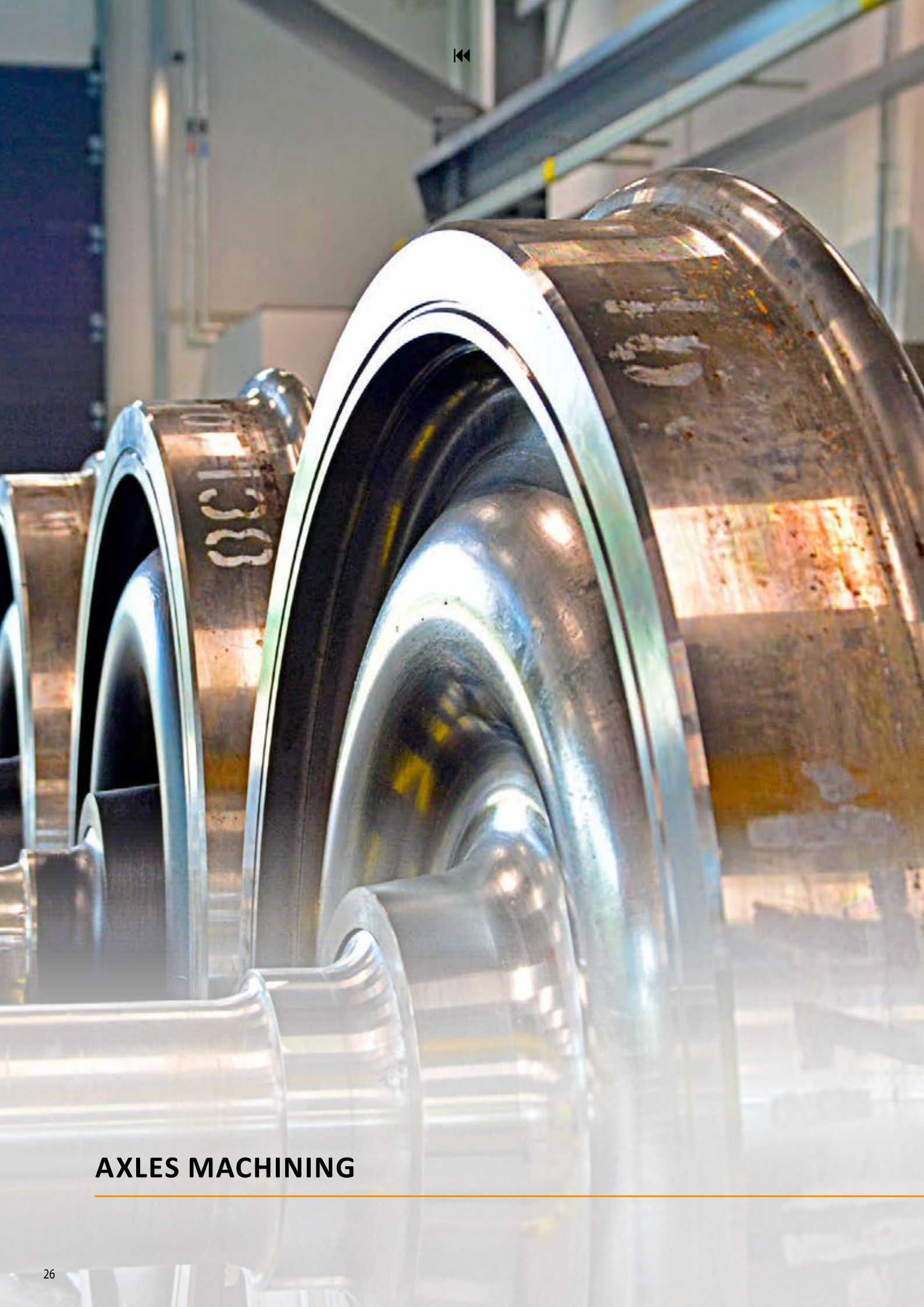

AXLES MACHINING



AXLES MACHINING

Axles are parts of the wheel-sets where the wheels are pushed onto. There are axles for locomotives, freight cars, passenger cars, high-speed rails, urban rails, industrial and other engineering vehicles.

Axles are made of carbon steel, alloy steel, stainless steel or other special materials. Axles are a product which require great responsibility and variability in the design and manufacturing process according to the different trends followed in different countries.

The majority of these parts are manufactured from forged pieces and a major focus is that our tools maximize process reliability and the quality of roughing and finishing operations. New axles are machined using a lathe to a standardized shape. Most of the machining is done by turning operations, but there are also operations of drilling and tapping.

Dormer Pramet offers standard assortment of roughing and finishing turning tools. Large, negative inserts with chip-breakers are suitable for high material removal where rigidity of inserts is vital. On the other hand, smaller positive inserts with sharp geometry are used for achieving a fine surface quality.

Among the standard assortment of solid drills, indexable drills, Hydra drills and taps, we can also offer its special tailor-made variants.





MACHINING PROCESS – EXTERNAL TURNING

External turning, semi-roughing to super heavy-roughing operations



Turning of the seat for wheel
 Holders PCLN(RL) 4040 S 25 and PCBN(RL) 4040 S 25 with rigid single sided CNMM 250924 inserts with various available geometries for semi-rough to super heavy-rough machining and continuous to interrupted cuts. All available in grades for material groups P, M, K and S.



	923	HR	NR2	OR
f	0.45-1.5	0.5-1.4	0.2-1.6	0.25-1.7
a_p	3.0-16.0	5.0-14.0	1.0-16.0	2.0-16.0

Turning of the center part

Holders PSBN(RL) 4040 S 25 with rigid single sided SNMM 250924 inserts with various available geometries for semi-rough to super heavy-rough machining and continuous to heavy interrupted cuts. All available in grades for material groups P, M, K and S.

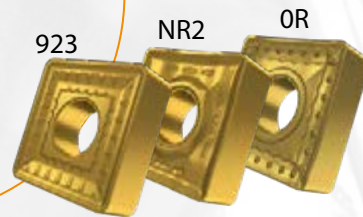

External turning, finishing operations

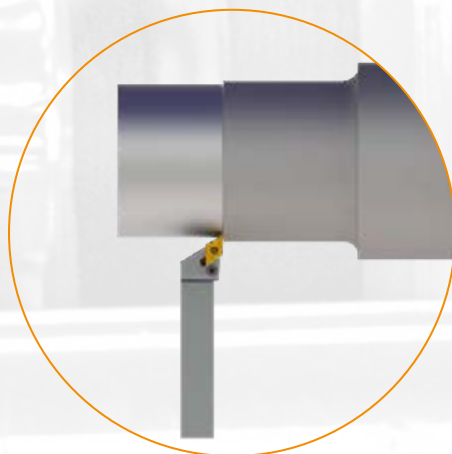

Finishing of wheel seats and axle center part

Holders PDJN(RL) 2525 M 15 with rigid negative double sided DNMG 150612 inserts with various available geometries for semi-rough to finish machining and continuous cuts.

Holders SRDCN 2525 M 12 with positive single sided RCMT 12 1204MO inserts with various available geometries for rough to fine-finish machining and continuous to interrupted cuts.



	FM	M	MR	UR
f	0.1-1.0	0.17-0.80	0.2-0.75	0.15-1.0
a_p	0.3-5.0	0.8-5.0	0.5-5.0	0.5-5.0

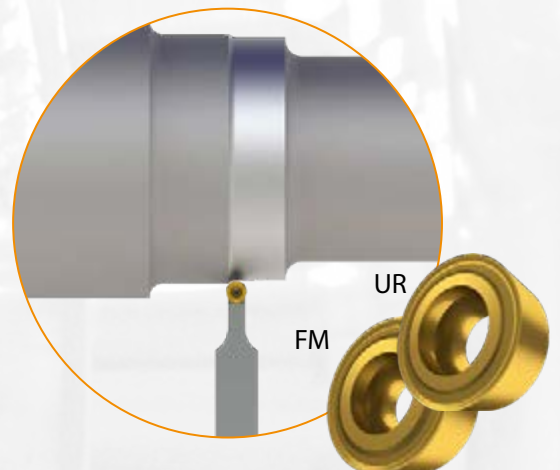



MACHINING PROCESS – MILLING, DRILLING & TAPPING



HYDRA: High performance replaceable head drills

Interchangeable solid carbide head drills for high performance machining of steels, stainless steels and cast iron. Fail-safe head location can be changed without ejecting the drill from the machine. Available with coolant feed and a choice of HSS bodies from 1.5xD for improved rigidity in shallow hole and plate drilling, through to 12xD for deeper hole applications. Available in \varnothing 12.0 – \varnothing 42.0 mm.



R457: FORCE X Solid Carbide Drill with Coolant Feed

High performance drill, capable of producing high quality and accurate holes even at high speeds and feeds (H9 hole tolerance). Self centering 140°. TiAlN coating increases surface hardness and improves tool life at high RPM. Available in \varnothing 3.0 – \varnothing 20.0 mm.



G138: HSS Taper Shank Countersink with 90° Angle, Bright Finish

A 90° Countersink designed for chamfering standard fastener holes and removing burrs from drilled holes. Taper shank design allows the tool to be used in machine applications where it is held directly in the spindle. Suitable to chamfer holes in many materials. Available in \varnothing 25.0 – \varnothing 80.0 mm.



E258: HSS-E-PM 15° Spiral Flute Machine Tap, Metric, DIN376 Standard

Slow spiral flute tap for up to 1.5xD deep blind holes. With 15° helix for more stability threading in harder and higher strength steels. The reduced shank increases the reach of the tap. (M4 – M36).

SHN09C, ECON HN, 45° Face Mill with Double Negative Design and Internal Coolant for milling of axles faces

Highly productive 45° face mill utilising double sided HN..09 style inserts with APMX of 5 mm. Roughing, finishing and chamfering. Economical insert with 12 cutting edges. Arbor mounting only, in range from \varnothing 50 up to to \varnothing 315 mm.





STATIONARY & DYNAMIC RAIL MILLING



RAIL MILLING

Rail treatment

There are several reasons for rail treatment. Primarily it is an issue of operational safety. On account of the mechanical stresses in wheel/rail contact, cracks (head checks) appear on the surface of the rail. These have to be removed before they spread and destroy the rail.

Dynamic rail milling

When renovating railway lines there are generally two preferred options, grinding or dynamic milling. Compared to grinding, the high-speed re-profiling of a line represents significant time and financial savings. Specially designed trains, operating at a constant speed of 700 meters per hour machine the existing track profile. By removing millimeters of metal from the damaged surface, the track is restored to its original condition. With each application, the first cutter roughens the surface, the second one finishes it, and the two units act on both rails simultaneously.

The operation provides a high-quality surface finish, while metal chips produced during the milling stage are transferred to a nearby container, ensuring no debris is left on the track. This 'on the-move' application requires specialized equipment to achieve optimum results, such as train machine tools designed to carry dynamic rail milling cutters and inserts. An increasing number of these are being produced by leading global manufacturers as demand from railway organizations and government bodies for track maintenance increases.

One of the big advantages of rail milling is the possibility of changing rail profiles. Profiles for high-speed trains and for operation at speeds up to 160 km/h can only be changed through milling. Milling is also necessary to reduce the amount of noise generated by trains and to correct the track gauge.

Stationary rail milling

Stationary rail milling is an operation that is done in a workshop. Rails with a usual length of 120 m are pushed through the stationary machine tool, where a similar cutter to the one used for dynamic rail milling is machining a rail head to ensure a good surface quality as well as a modification of an overall rail height.





DYNAMIC RAIL MILLING CUTTERS

Dormer Pramet offers several designs of milling cutters that can be used for rail milling. They differ in size (diameters 290 mm, 600 mm and 900 mm), in clamping system (usage for different machine tools, cutters \varnothing 600 mm are suitable for most of the Linsinger trains and trucks) and in the machined profile (depends on the rail profile).

All our solutions have common features and advantages. All cutters are designed as an assembly of universal tool body and interchangeable cartridges with indexable tangential inserts.

The advantage of this solution is an easy exchange of the machined profile just by changing the cartridge type or even just by changing some inserts in the cartridge or exchanging of just some cartridges in case of their damage during the machining process. This possibility saves money and decreases downtime and the storage space requirements.

Main components

Tool body – There is always one universal tool body for each cutter diameter that can be used for the right-hand and the left-hand cutter as well as for roughing and finishing operation. Connection cone and facing and seats for cartridges are produced with very high precision to ensure minimum overall radial and axial run-out.

Cartridges – Right-hand and left-hand cartridges are fixed to the tool body by the screw(s). Some of the cartridges can be used for machining more than one type rail profile (e.g., cartridges CA-502-000 and CA-503-000 can be used for 60E1, 54E1 and 46E3 profiles with rail inclination 1:40).

Indexable inserts – Reliability of inserts is the key for machining of rails where every stop of the train can cause a lot of problems. The reliability of our inserts is ensured by the insert size (IC = 15 mm, s = 7.94 mm) and by the usage of reliable PVD grades (7310 and M8310). Flat inserts are having 8 cutting edges while inserts with radiuses are having 4 cutting edges.

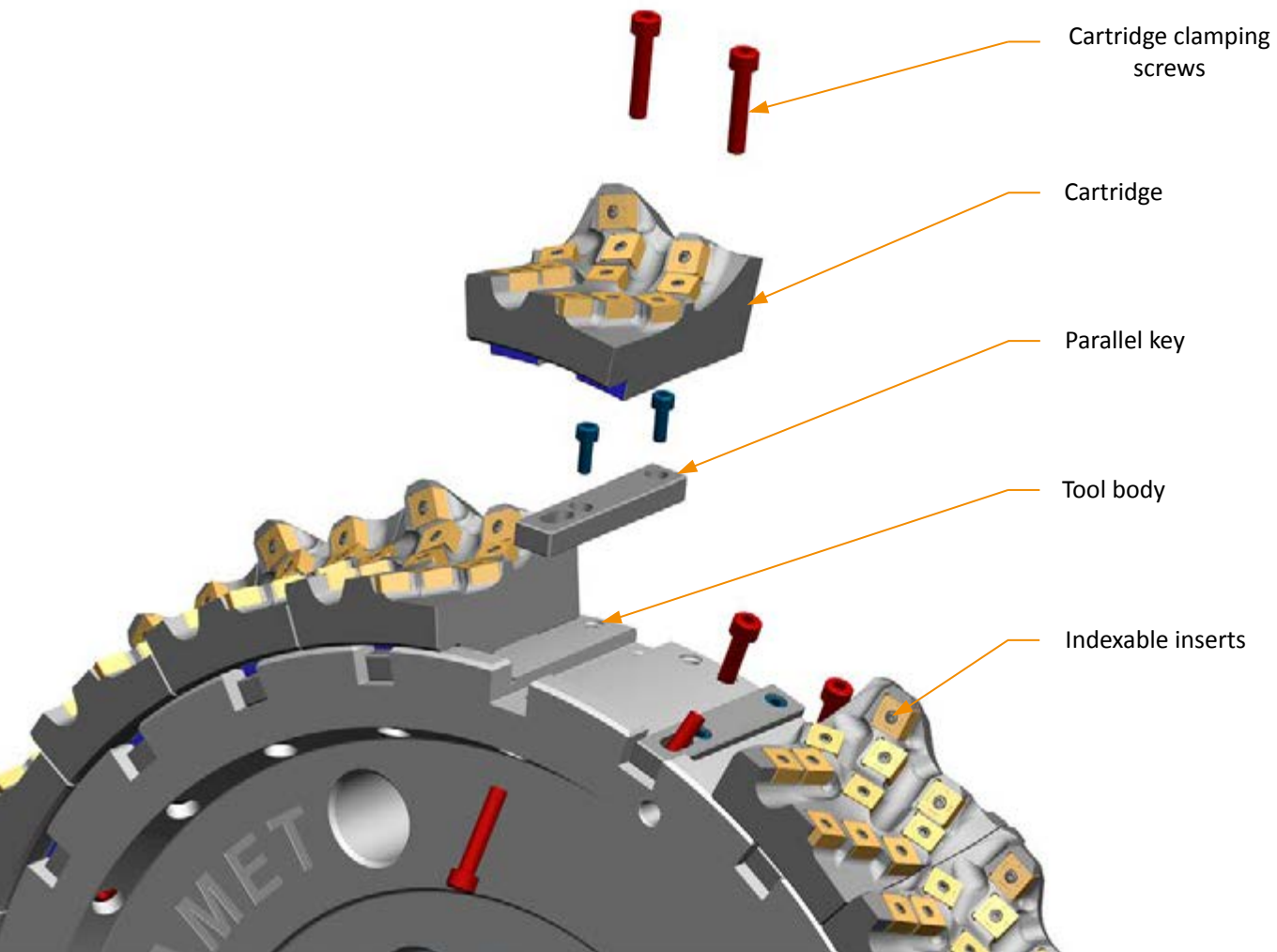



MILLING CUTTERS OVERVIEW

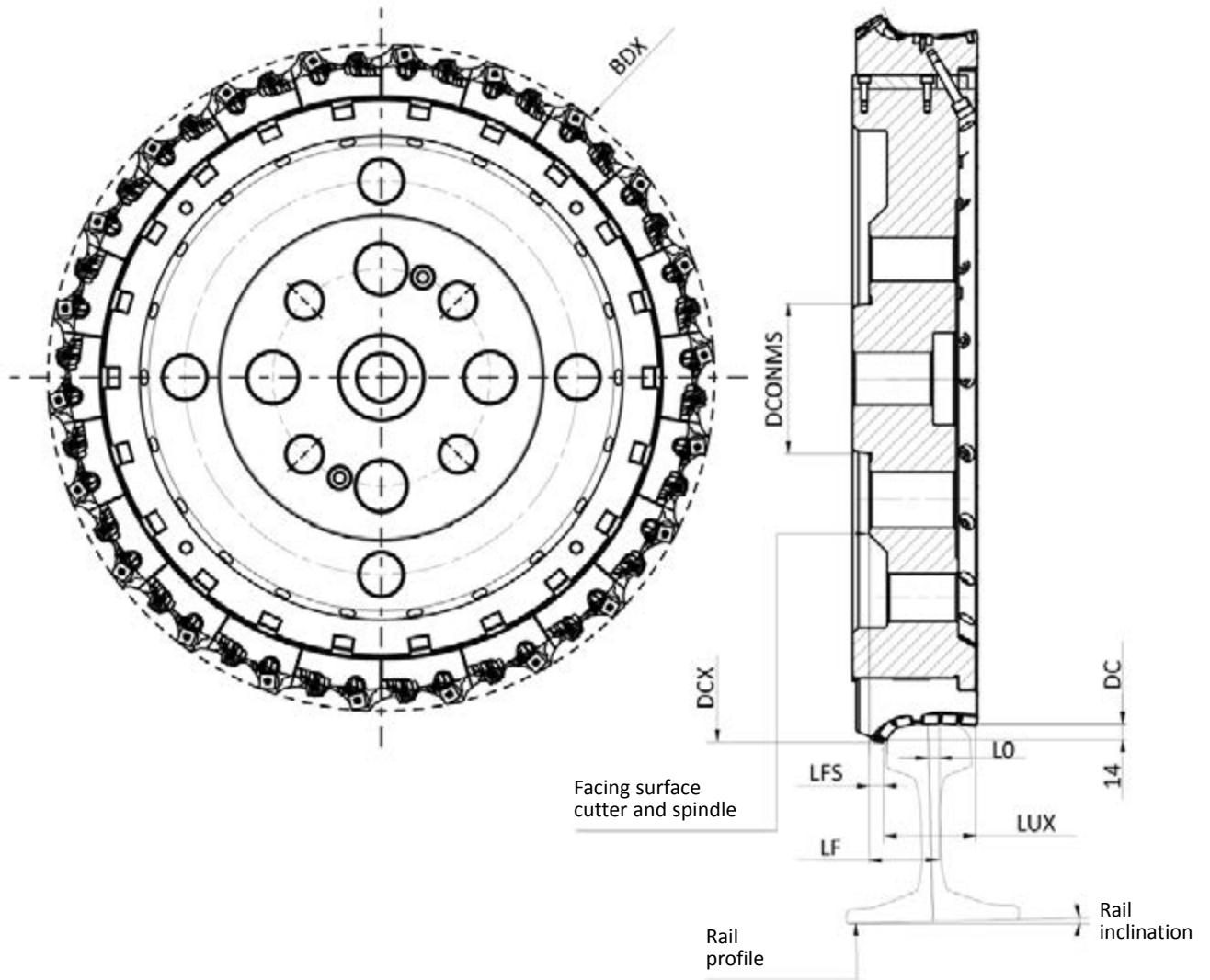

Product	Rail profile	Rail inclination	HAND	DC (mm)	DCX (mm)	DCONMS (mm)	BDX (mm)	LF (mm)	LFS (mm)	LUX (mm)	L0 (mm)		CIC
S-290R10-CA526-000809	60E1	1:20	R	290	332.6	135.00	336.3	64.0	29.00	80.30	11.49	10	110
S-600R22-CA502-000697	60E1	1:40	R	600	643.8	130.00	650.0	58.6	15.60	78.90	7.50	22	242
S-600L22-CA503-000698	60E1	1:40	L	600	643.8	130.00	650.0	58.6	15.60	78.90	7.50	22	242
S-600R22-CA438-000546	60E1	1:40	R	600	643.0	130.00	650.1	57.8	14.77	79.30	7.50	22	176
S-600L22-CA439-000547	60E1	1:40	L	600	643.0	130.00	650.1	57.8	14.77	79.30	7.50	22	176
600R22-CA252-657-130	60E2	1:40	R	600	643.2	130.00	644.5	56.1	15.60	80.10	5.00	22	242
600L22-CA253-657-230	60E2	1:40	L	600	643.2	130.00	644.5	56.1	15.60	80.10	5.00	22	242
600R22-CA252-657-130	60E2 AHC	1:40	R	600	643.2	130.00	644.5	56.1	15.60	80.10	5.00	22	242
600L22-CA253-657-230	60E2 AHC	1:40	L	600	643.2	130.00	644.5	56.1	15.60	80.10	5.00	22	242
S-600R22-CA502-000697	54E1	1:40	R	600	643.8	130.00	650.0	57.7	15.60	78.90	7.50	22	242
S-600L22-CA503-000698	54E1	1:40	L	600	643.8	130.00	650.0	57.7	15.60	78.90	7.50	22	242
S-600R22-CA491-000629	54E5	1:40	R	600	643.8	130.00	650.0	54.2	15.60	78.90	4.17	22	242
S-600L22-CA492-000630	54E5	1:40	L	600	643.8	130.00	650.0	54.2	15.60	78.90	4.17	22	242
S-600R22-CA502-000697	46E3	1:40	R	600	643.8	130.00	650.0	59.5	15.60	78.90	7.50	22	242
S-600L22-CA503-000698	46E3	1:40	L	600	643.8	130.00	650.0	49.5	15.60	78.90	7.50	22	242
S-900R34-000445	60 TBT2344	1:40	R	900	948.2	285.78	945.0	69.0	26.54	78.83	7.50	34	374
S-900L34-000446	60 TBT2344	1:40	L	900	948.2	285.78	945.0	69.0	26.54	78.83	7.50	34	374

CARTRIDGE POCKET NUMBERING

Left-hand cartridge

Valid for cartridges:
CA-253-000, CA-492-000,
CA-503-000

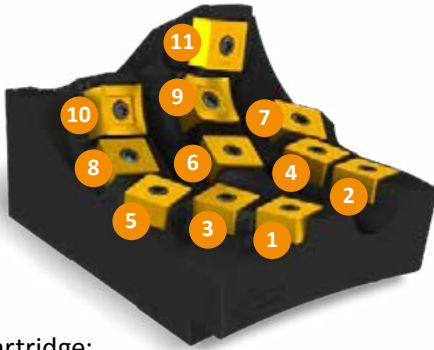

Valid for cartridge:
CA-439-000



Valid for cartridge:
CA-432-000

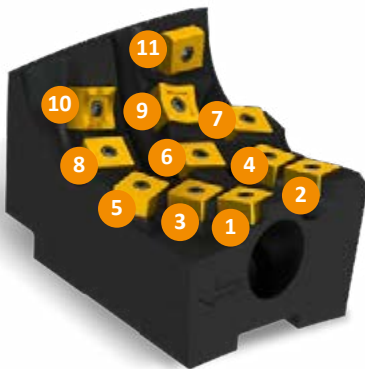

Right-hand cartridge

Valid for cartridges:
CA-252-000,
CA-491-000,
CA-502-000



Valid for cartridge:
CA-438-000



Valid for cartridge:
CA-431-000

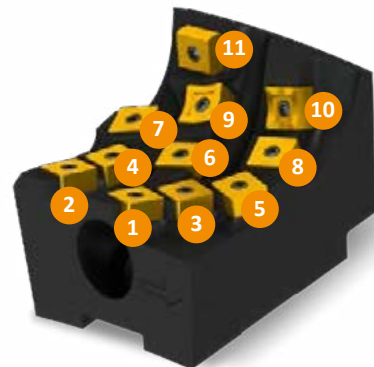

Valid for cartridge:
CA-526-000



DYNAMIC RAIL MILLING CUTTERS & INSERTS

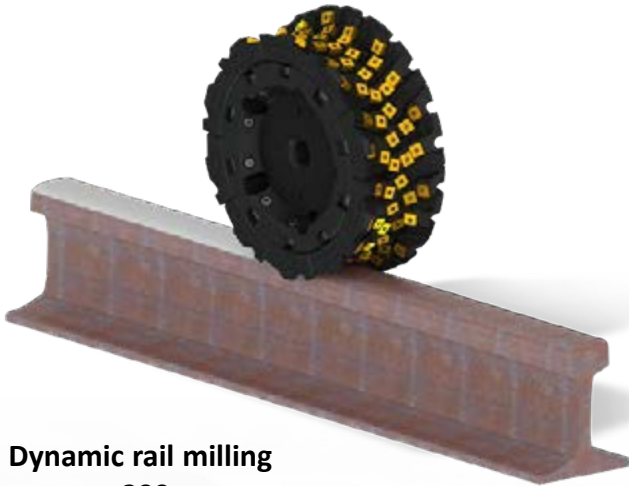

Dynamic rail milling cutter \varnothing 290 mm

Milling cutter for machining of the rail profile 60E1, 1:20 contains 10 easily interchangeable cartridges clamped by 3 screws, each containing 11 indexable inserts.



Dynamic rail milling cutter \varnothing 600 mm

Milling cutter for machining of rails that consist of universal basic body and 22 easily interchangeable cartridges clamped by 3 screws, each containing 11 indexable inserts. That is 242 inserts altogether. Cutting profile is defined by the used cartridges. Cartridges available for rail profiles 60E1, 60E2, 54E5, 54E1, 46E3 and others upon request. Milling cutter is suitable for Linsinger milling machines.



Dynamic rail milling cutter \varnothing 900 mm

Milling cutter for machining of rails that consist of universal basic body and 34 easily interchangeable cartridges clamped by one screw, each containing 11 indexable inserts. That is 374 inserts altogether. Cutting profile is defined by the used cartridges. Available cartridge for rail profile 60 TBT and others upon request.



Tangential indexable inserts

Inserts with higher thickness and IC for better rigidity. Usage of PVD grades (7310 and M8310) also increase reliability. Flat inserts (S-SNEX 15-2462000) that are used in all pockets (11) in cartridge doing roughing operation and in 9 out of 11 pockets in each cartridge doing the finishing operation are having 8 cutting edges while inserts with radiuses (insert type depends on the machined rail profile) that are used just for finishing operation in pockets 9 and 10 are having 4 cutting edges.



TURNOUTS MACHINING

TURNOUT ASSEMBLY

Turnouts are mechanical installations enabling railway trains to be guided from one track (A) to another (B or C) see picture. A switch generally has a straight "through" track (such as the main-line) and a diverging route. A straight track is not always present, for example, both tracks may curve, one to the left and one to the right.



- A – Crossing (frog)
- B – Stock rail
- C – Lead (closure) rails
- D – Tongue (Switch) rail
- E – Guard (check) rails
- F – Outside (running) rails
- G – Base (sole) plates
- H – Fish plate
- I – Stopper
- J – Stretcher bar
- K – Slide chair
- L – Connecting plate
- M – Switch motor
- N – Rail brace
- O – Washer
- P – Sleeper
- Q – Drive (switch) rod
- R – Heel (distance) blocks

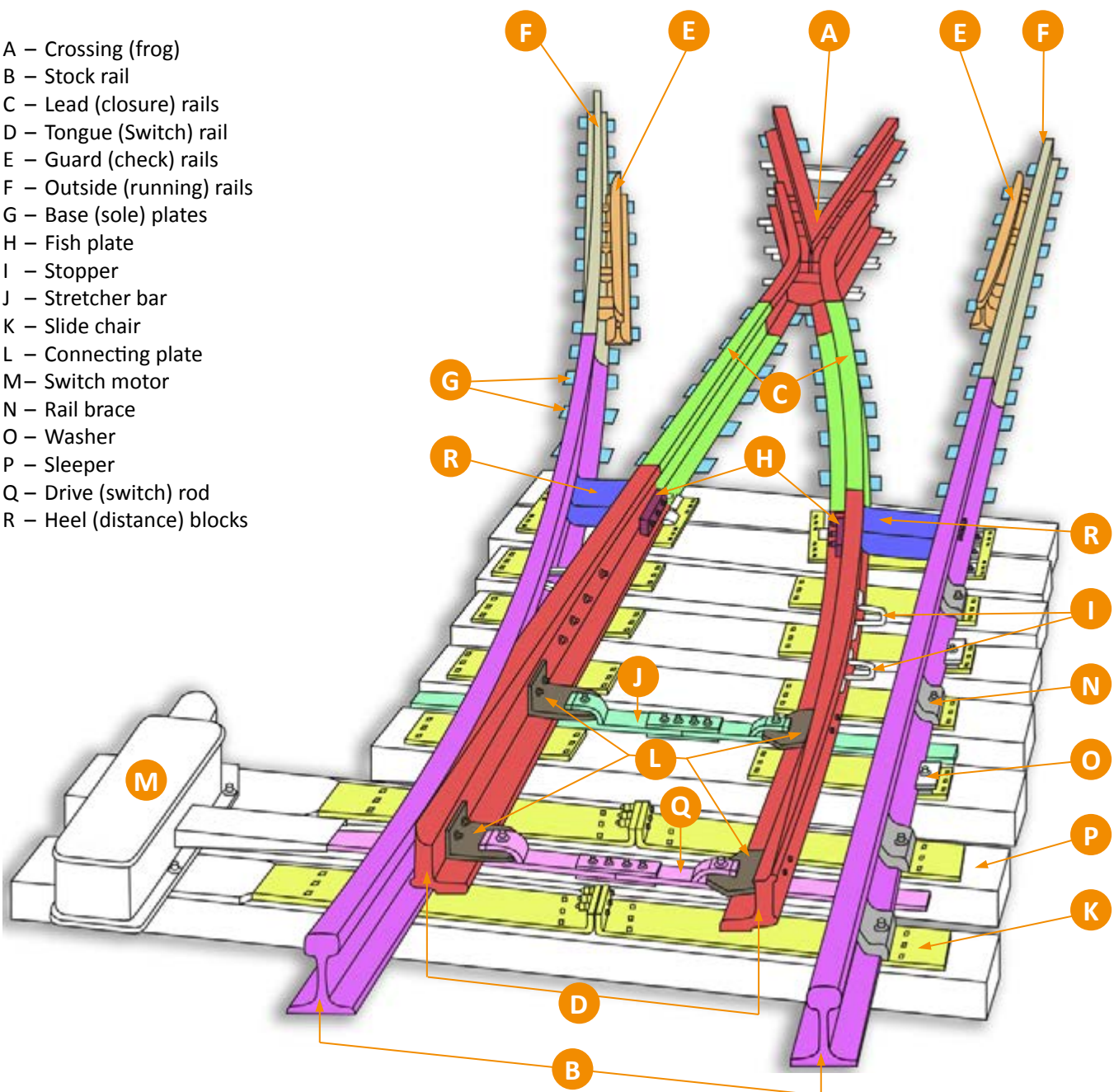

Crossing (frog) (A) – It is an arrangement of rails introduced at the junction where two rails cross to permit the wheel flange of the train to pass from one track to another.

Nose – is a most stressed part of the crossing. The wheel is in the air for just a short moment when it leaves the toe of the crossing and then it hit the nose. It happens everytime the train goes through the crossing.

Wing rail – rails which are used to guide the inner wheel flange of the train.

Guard (check) rails (E) – they are the rails which are used to guide the outer wheel flange of the train. They ensure that the train does not derail.

Crossings can be Mono-block (casted) or can be produced as an assembly (bolted or welded). There is a lot of machining operations on both types. Used tools and cutting conditions differs also because of different workpiece materials.

Manganese steel crossing:

Most crossings are produced from manganese steels (so called “Hadfield steel”)

- Manganese content 12 – 14 %.
- Very high wear resistant and tough material with hardness 200 – 280HB (before heat treatment)
- Material examples X120Mn12 / 1.3401 / 17 618.4
- Material is getting harder during machining process

Bainite crossings:

- Low carbon content $\leq 0.4 \%$
- Very high wear resistance, 49 HRC, tensile strength 1.400 – 1.600 MPa
- Weldable
- Material examples Bainite 1400, Bainite 1400 plus, Bainite 1100, Bainite 1000

Machining process

Because most of the crossings or its parts are casted, there are a lot of machining operations. A rough workpiece is milled by special profile milling cutters to its final shape. Crossings from both materials are difficult to machine due to each materials’ characteristics. This is valid especially for manganese steel crossings where the material is getting harder after machining. Therefore, usually just one pass is used. Stock allowance is not equal, so the radial and axial depth of cut is changing. Tangential inserts made of tough grade (e.g., M8345 and M8346) with strong cutting edge together with big cutters in terms of diameter as well as in cutting length is highly recommended to be used to provide the needed productivity and reliability of the machining process.

The grade M8345 (M8346) is the first choice for these applications. This grade has exceptional operational reliability and is designed for heavy cuts in unfavorable conditions in difficult and tough materials.

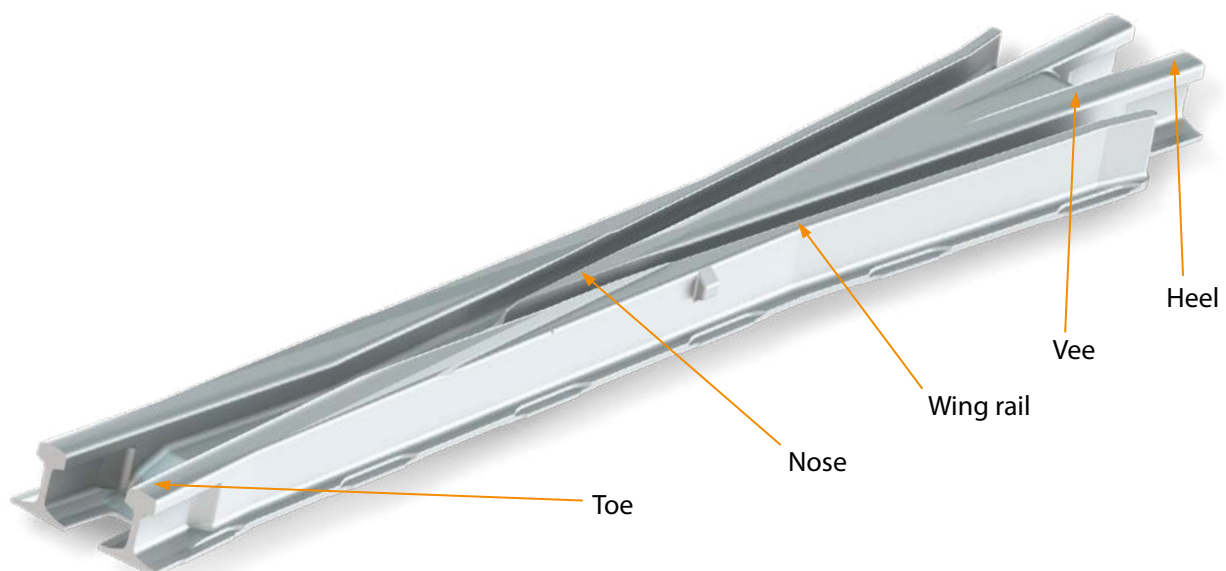

Tongue (switch) rail (D) - It is the moving part of the switch which diverts the train from one track to the other. Tongue rails lie between the two stock rails in the turnout assembly. Top and side of the tongue rail is tapered in such a way that they do not bear any load.

Stock rail (B) – They are the main rails of the track to which the tongue rails are fit closely. They are the outer rail in the turnout.

Heel (distance) blocks (R) – These are the blocks inserted between the heel of the stock rail and the tongue rail. It provides a clear gap for the wheel flange.

Slide chairs (K) – These are the special plates that provided for supporting and sliding the toe of the tongue rail. It helps the tongue rail to move toward and away from stock rails and tongue rails are able to slide.

Lead (closure) rails (C) – One side of the lead rail is connected to the heel of the tongue rail whereas the second side is connected to the toe of the crossing.

Stretcher bars (J) – Used to connect the toe of the tongue rails so that both tongue rails move through the same distance.

Tongue rails belong to the parts of the turnout assembly that need to be machined to the specific shape. Tongues are made of the same materials as standard stock rails (R260, R350HT,... see full table in the technical section). Gantry machines with long tables are usually used for such a machining. Tongues are fixed by clamps or by magnetic clamping to the table.

Dormer Pramet offers various milling cutters for machining of lots of different tongue rail profiles. Tapered cutters for machining the stock rail side of the tongue, tapered cutters with radius for machining of the wheel side as well as cutters for machining of the tongue rail head part are the most common tools.

Grade M9325 is a first choice for milling inserts. This grade has an ideal balance between wear resistance and toughness, it is mainly designed for roughing operations. Advantages are excellent wear resistance even at relatively high cutting speeds with excellent reliability. The grade is more suitable for applications using higher speeds and lower feed rates. The second choice is grade M8346 because of its exceptional operational reliability and suitability for heavy cuts in unfavorable conditions.

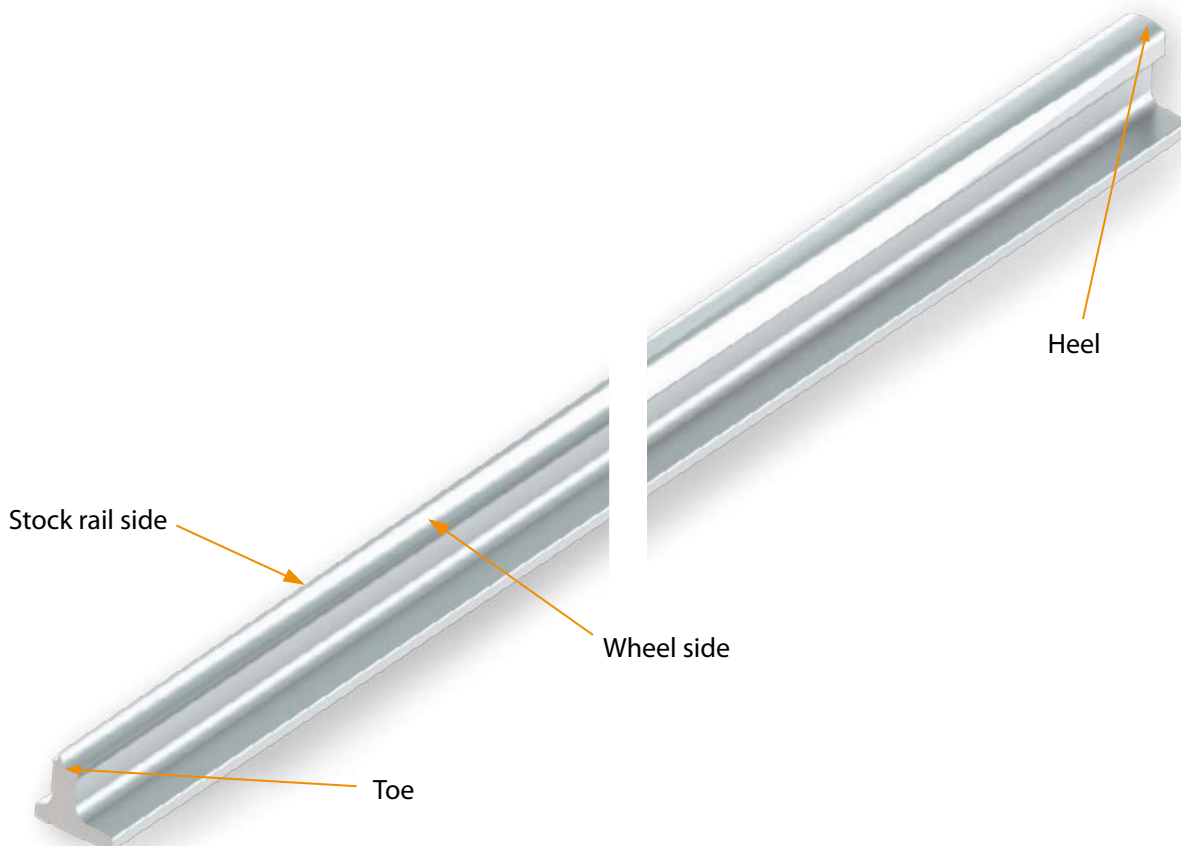



CROSSING – MACHINING OF BOTTOM SURFACE

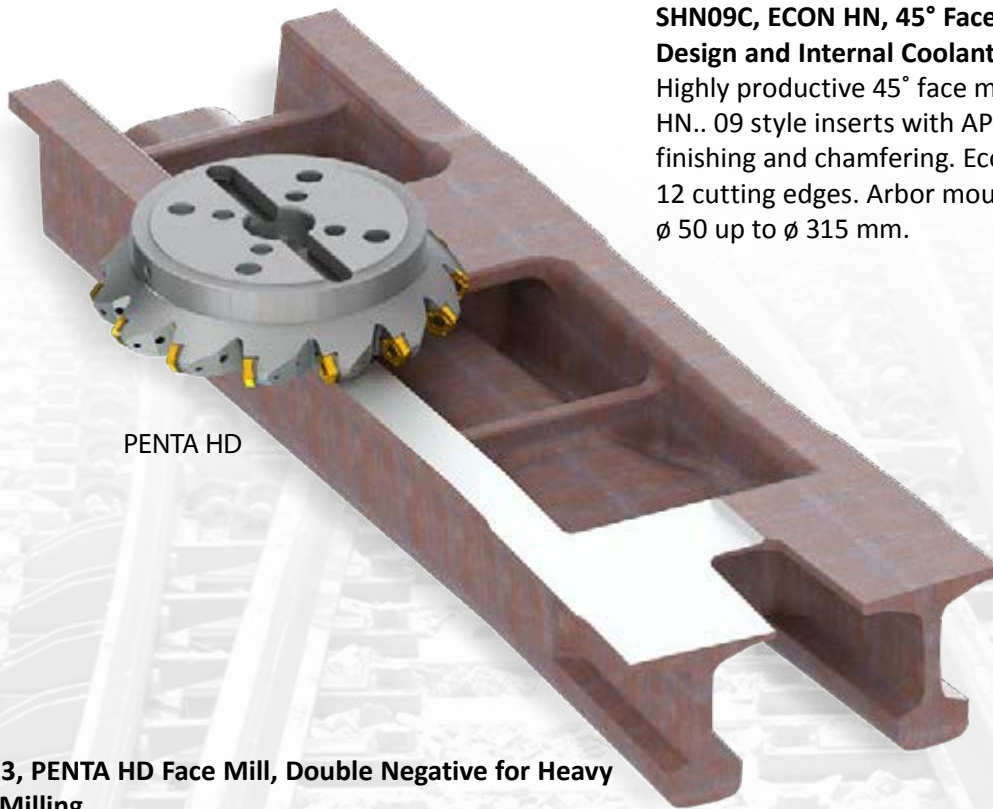

PENTA HD

SHN09C, ECON HN, 45° Face Mill with Double Negative Design and Internal Coolant

Highly productive 45° face mill utilising double sided HN.. 09 style inserts with APMX of 5 mm. Roughing, finishing and chamfering. Economical insert with 12 cutting edges. Arbor mounting only, in range from \varnothing 50 up to \varnothing 315 mm.



ECON HN

SPN13, PENTA HD Face Mill, Double Negative for Heavy Face Milling

High productive 57° face mill for double sided PN.. 13 and XN.. 13 style inserts with max. cutting depth APMX of 10 mm. Suited for face milling. Arbor mounting only, in range from \varnothing 100 up to \varnothing 315 mm. Insert seat protected with shim. Easy insert exchange.



Special \varnothing 250 mm cutters

1 – High productive 43° face milling cutter with 16 cartridges to protect the body. Double sided negative inserts with max. cutting depth APMX of 15 mm.

2 – Face milling cutter for heavy milling applications with positive RCMT 20 inserts and APMX of 10 mm. Additional clamp for proper insert clamping. Insert seat protected with shim.

3 – 75° face milling cutter with smaller tangential double-sided inserts with 8 cutting edges and max. cutting depth APMX of 5 mm.





CROSSING – MACHINING OF BOTTOM ENDS AND COPY MILLING



SRC16, 20

SRC16 and SRC20, Profile or Copy Milling Cutter for Round Inserts Size 16 and 20

Milling cutter for medium to heavy profile and copy milling with positive RCMT 16 inserts and APMX of 8 mm and RCMT 20 inserts and APMX of 10 mm. Suitable for face, helical interpolated, ramping, progressive plunge, and high feed milling. SRC16 available in arbor mounting only and coolant through, in range \varnothing 63 up to \varnothing 160 mm. SRC20 available in arbor mounting only and coolant through, in range \varnothing 80 up to \varnothing 160 mm.



SRD12 and SRD16, Copy Milling Cutter for Round Inserts Size 12 and 16 with Coolant Through

Milling cutter for profile and copy milling with positive RD.. 12 and 16 inserts and APMX of 3 mm and 4 mm. Suitable for face, helical interpolated, ramping, progressive plunge, copy, and profile milling. SRD12 available in modular and arbor mounting, in range \varnothing 24 up to \varnothing 80 mm. SRD16 available in modular and arbor mounting, in range \varnothing 32 up to \varnothing 100 mm.



SRD12, 16

K3-CXP



L2-SZP



L2-SZP, Ballnose Profile Milling Cutter for ZP.. Style Inserts

Ballnose milling cutter for ZP.. style inserts with APMX from 8.9 up to 44.7 mm. Suitable for copy, and profile milling. Available in cylindrical, weldon, morse taper and modular mounting, in range \varnothing 10 up to \varnothing 50 mm.

K3-CXP, MULTISIDE XP Profile Milling Cutter for XP.. Style Inserts

Ballnose milling cutter for XP.. style inserts with APMX from 8 up to 16 mm. Suitable for productive copy, and profile milling by 3 inserts for higher productivity. Available in cylindrical and modular mounting, in range \varnothing 16 up to \varnothing 32 mm.





1 – Corner rounding arbor style cutter
 ø 100 mm with 5 effective teeth for machining of outer radii. Positive tangential inserts with 4 cutting edges with various radius sizes.

2 – Corner rounding shank style cutter
 Shank style (weldon) cutter with the smallest ø 7 mm available with several different radii for machining in hard-to-reach places. Two effective teeth with usage of just one insert.

3 – Corner radius cutter
 Shank style (weldon) cutter for machining of fillet radii together with an inclined wall. Cutter can be used in narrow grooves due to its small diameter ø 16 mm. Two effective teeth with usage of just one insert.

4 – Corner rounding cutter
 Shank style (weldon) cutter ø 40 mm with 3 effective teeth for machining of outer radii. Positive tangential inserts with 4 cutting edges with various radius sizes.





CROSSING – MACHINING OF HEAD

1



1 – Robust disc milling cutter for face milling
ø 320 mm with a lightweight modification for machining of flat surface of the crossing. Smooth cutting process with tangential inserts with 8 cutting edges.

2



2 – Concave style milling cutter for machining of the wing rails
maximum ø 340 mm with very wide cutting area for milling of corner radius (R13), top radii (R80, R300) and two inclined faces (1:20, 1:10).

3 – Pot-shaped milling cutter for machining of the top of the toes
ø 330 mm for machining of top radii (R13, R80, R300), flat and inclined (1:8) surfaces. Thick tangential inserts with 8 cutting edges suitable for heavy cutting conditions.

4 – Disc milling cutter for machining of the top of the rail head
ø 350 mm, machining of corner radius (R13) and the side of the head in the groove. Protective inserts in the biggest cutter diameter in case of extra material removal need.

4



3



5 – Milling cutter for machining of the top of the toes
ø 200 mm with corner radius R1.2 mm for machining of inclined surface (1:20) and 90° wall.

5

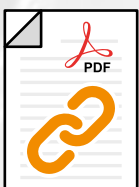

1 – Disc milling cutter for groove machining
 ø 420 mm cutter, for machining of the groove walls (1:20, 1:5) and bottom radius (R15).
 Productive solution due to the strong body design with 8 effective teeth and tangential inserts usage.

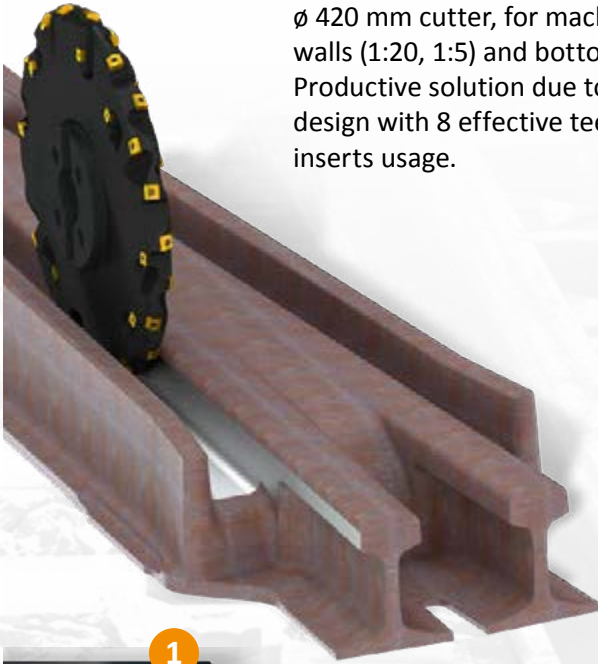

1

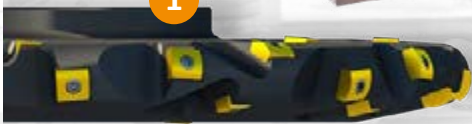

2

2 – Disc milling cutter for machining of the groove wall
 ø 250 mm cutter with 6 effective teeth for machining of the side of the groove with a short relief radius. Rigid tangential inserts with 8 cutting edges, respectively 2 cutting edges (radius inserts) ensure the cutting process reliability.



4 – Shank style milling cutter for machining of grooves
 ø 22 mm cutter with positive cutting inserts for machining of the radius R13 and tapered wall.

3 – Disc milling cutter for 90° wall machining
 ø 420 mm cutter for machining of the 90° wall and the bottom radius (R10) in the groove. 10 effective teeth, 30 tangential radius inserts with two cutting edges each.

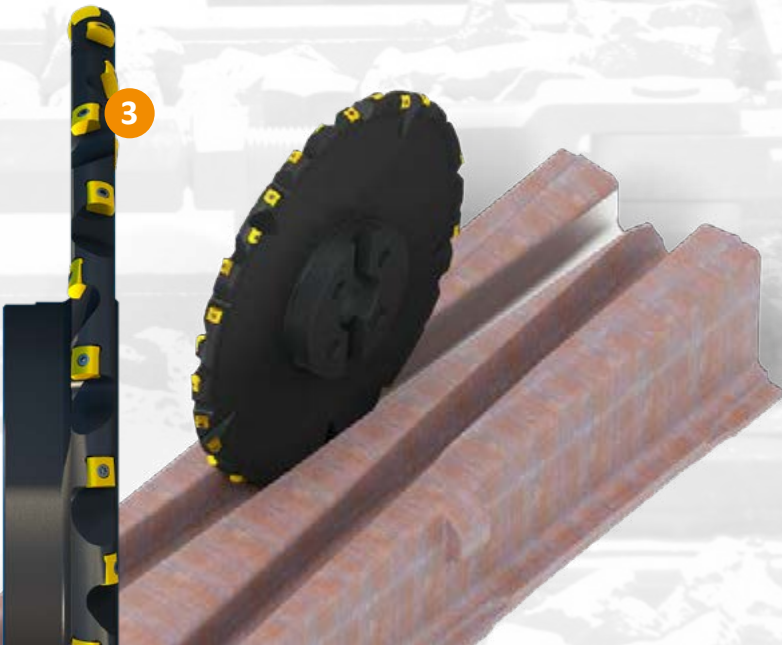

3



4



CROSSING – MACHINING HEEL AND TOE

J(T)-SLSN, ROUGH SN, Long edge Endmill for Heavy Milling with Coolant Through

90° long edge end mill with LNET 16 and SN.. 13 inserts and APMX of 104 up to 134 mm. Body with main shaft and separable headpiece. Suited for shoulder, slot, face or plunge milling. Available in DIN 69871, BT and DIN 2080 50 taper mounting, in \varnothing 63 and \varnothing 80 mm.

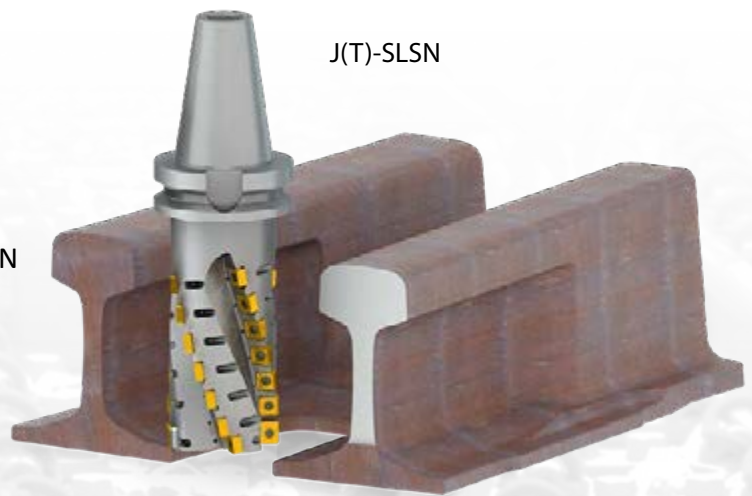

J(T)-SLSN

J(T)-SAD16E



J(T)-SAD16E, HELICAL AD, Long Edge End Mill for AD.. Insert for Medium Milling

90° long edge end mill for positive AD.. 16 inserts with APMX of 40 up to 108 mm with coolant through. Suited for shoulder, slot, face or plunge milling. Available in arbor, ISO, BT and 2080 taper mounting, in \varnothing 50 up to \varnothing 100 mm. Available with differential tooth setting.

Special Long Edge Endmill for heavy Milling with separable headpiece

90° long edge end mill for rigid negative inserts with APMX of 77 up to 100 mm with coolant through. Suited for shoulder and face milling. Available in arbor mounting, in \varnothing 80 and \varnothing 100 mm in right and left hand version. Replaceable headpiece with tangential inserts with corner radius, main body with tangential inserts with 8 cutting edges.





1 – Multifunctional milling cutter

with tangential inserts that can be used for machining of the inclined top surface of the crossing, or it can be used for the machining of the slots for the braces (clamps) and their side.

2 – 75° face milling cutter

for machining of the top surface of the Vee and the nose where fine surface is needed. Tangential insert with corner radius and 8 cutting edges is used on the periphery as well as in the bottom as a wiper insert.



3 – Back face disc milling cutter

∅ 290 mm with tangential CNHQ 1005AZTN inserts suitable for machining of the bottom of the crossings and tongue rails.





CROSSING/TONGUE RAIL – MACHINING OF WEB

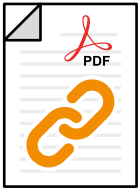

ECON LN Square Shoulder End Mill for LN.. Insert with Coolant Through

90° end, or shell mill for double sided LN.. 12 inserts with APMX of 9 mm. Suited for wide range of applications. Available in cylindrical, weldon, modular and arbor mounting, in \varnothing 25 up to \varnothing 125 mm. Available with differential tooth pitch.

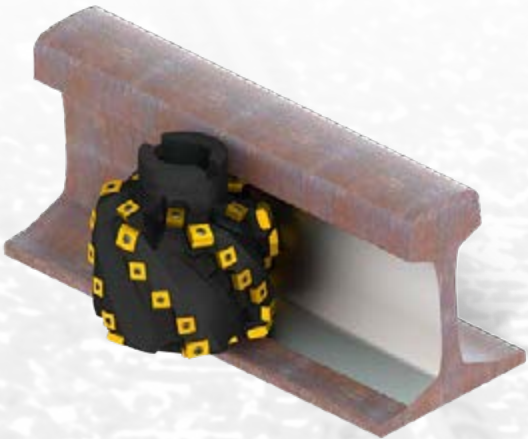

Special full profile milling cutter for web machining – one cutter/one pass

Rigid tangential inserts with 4 and 8 cutting edges. Cutter makes full profile in one pass. Suitable for strong and rigid machines.



Special half profile milling cutter for web machining – two cutters/two passes

Solid body cutter with ISO cone back-end. Rigid tangential inserts with 4 and 8 cutting edges. Cutter makes half profile.



Special profile milling cutter for web machining – one cutter/two passes

Rigid tangential inserts with 4 and 8 cutting edges. Cutter makes the profile in two passes therefore there are lower cutting forces and low vibrations.





TONGUE RAIL – MACHINING OF HEAD AND HOLEMAKING



Special profile milling cutter for machining of the rail head
Right and left-handed milling cutters for various rail profiles and its inclinations. Suitable for machining of the top of the rail head, corner radius and tapered wall on toes and heels of crossings and tongue rails. Tangential inserts increase reliability of the machining process.



HYDRA: High performance replaceable head drills
Interchangeable solid carbide head drills for high performance machining of steels, stainless steels and cast iron. Fail-safe head location can be changed without ejecting the drill from the machine. Available with coolant feed and a choice of HSS bodies from 1.5xD for improved rigidity in shallow hole and plate drilling, through to 12xD for deeper hole applications. Available in \varnothing 12.0 – \varnothing 42.0 mm.

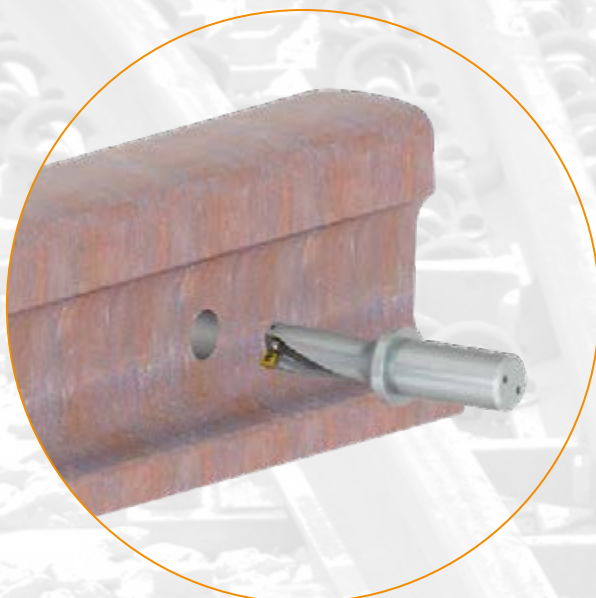

Indexable Insert Drill with Internal Coolant Feed
High performance indexable insert drill for drilling blind and trough holes and potentially cross-, off center-, helical and stacked material drilling, plunging, drilling on concave or sloped surfaces, drilling with interrupted cuts, chamfer drilling and even boring type drilling. Available from \varnothing 15 up to \varnothing 40 mm in 2xD, from \varnothing 15 up to \varnothing 58 mm in 3xD, from \varnothing 17 up to \varnothing 58 mm in 4xD and from \varnothing 19 up to \varnothing 31 mm in 5xD.

TONGUE RAIL – MACHINING OF TAPERS

Double sided tapered milling cutter

Special milling cutter in various diameters that can be held from both sides to allow machining of standard and inverted tapers with the same cutter body. Usage of rigid tangential inserts with 8 cutting edges makes the cutting process productive and reliable.



Double tapered milling cutter for tongue rails machining

Special milling cutter for machining of two connected tapers used for machining of faces on tongue rails that will be matched with mirrored faces on the stock rail. Tangential inserts with 8 cutting edges are used.



Tapered milling cutter for machining of tongue rails

Special milling cutter with $\varnothing 100$ for machining of inverted tapers on smaller machine tools. 8 cutting edges on each tangential insert make the process more economical.

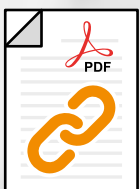

TONGUE RAIL – MACHINING OF WHEEL SIDE

Profile milling cutter for machining of tongue rails

Milling cutters for various rail profiles with minimum \varnothing 150 mm and maximum \varnothing 300 mm. Machining of the wheel side of the tongue rail. Tapered face, top corner radius and the top tongue rail surface. Cutter equipped with large tangential inserts on the largest diameter for higher depth of cuts.

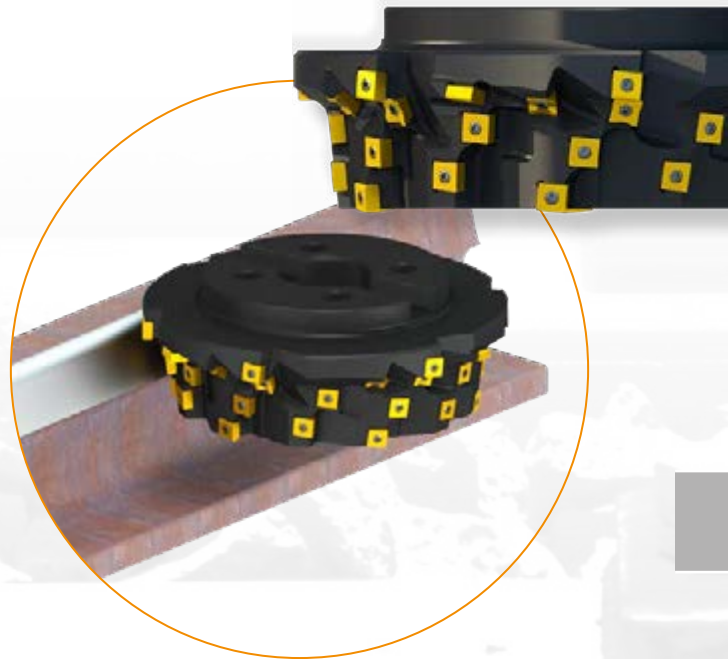

Profile milling cutter for machining of top radius and tapered face

\varnothing 200 mm profile cutter for machining of tongue rails. Tangential inserts with 8 cutting edges, resp. 4 cutting edges on radius inserts and on protective inserts on the top and the bottom.

Profile milling cutter for machining of tongue rails

Milling cutters for various rail profiles with minimum \varnothing 110 mm and maximum \varnothing 300 mm. Machining of the wheel side of the tongue rail. Bottom radius, tapered face, top corner radius and the top tongue rail surface. Cutter equipped with tangential inserts for high reliability.

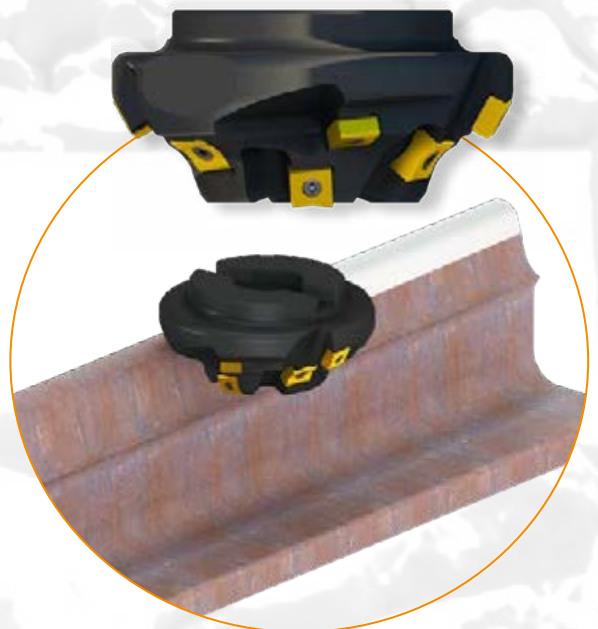
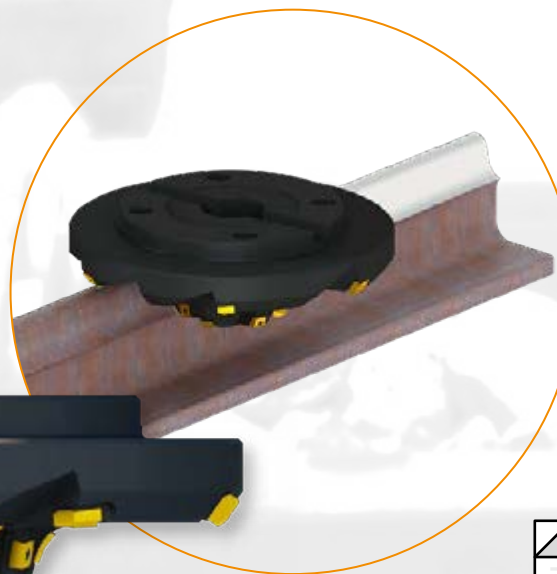

Cutter for machining of radius R13 and tapered faces from both sides

Small milling cutter with min. \varnothing 70 mm for machining of radius R13 and tapered surface 1:3. Double sided, 4 cutting edges radius inserts and 8 cutting edges double sided square inserts for high material removal rate.





TONGUE RAIL – MACHINING OF WHEEL SIDE



Tapered, arbor style milling cutters for machining of running side of tongue rails

Special right and left-handed milling cutters in wide range of diameters (\varnothing 80 – 200 mm), various setting angles KAPR (1:3, 1:4, 1:5,...), radius sizes (R13, R14, R20...) and cutting depths.

Square shaped rigid tangential inserts with 8 cutting edges, 4 or 2 cutting edges on radius inserts that ensures high material removal rate.

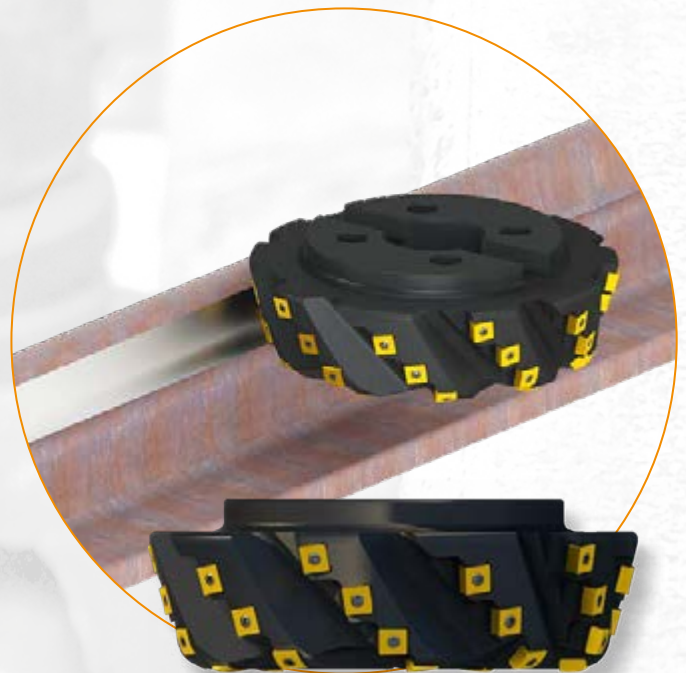

2516, 45° Chamfer Milling Cutter with Triangular Insert and Coolant Through

45° Chamfer milling cutter with single sided TC..16 inserts and APMX 8.5 mm. Suited for top side chamfering. Available in weldon mounting only, in range of outside \varnothing 31 and \varnothing 39 mm.

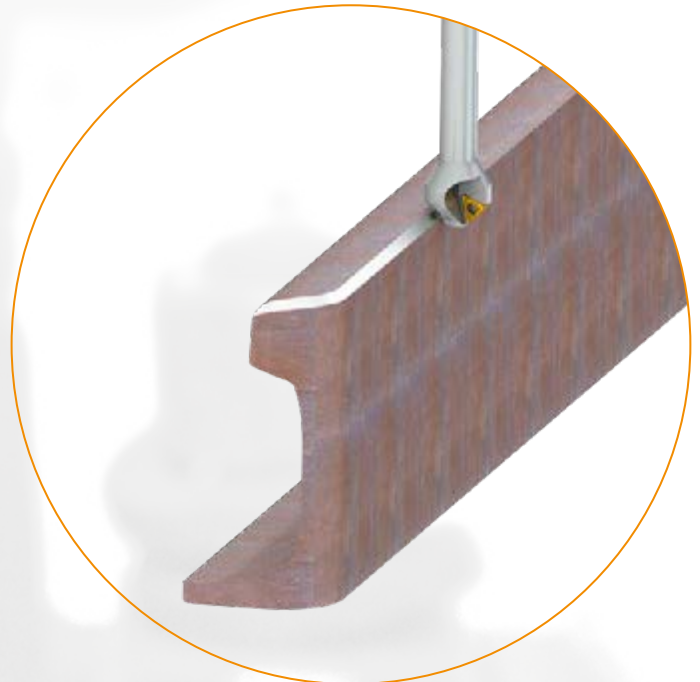

Special milling cutter for machining of 90° wall and the bottom chamfer

\varnothing 160 mm cutter for machining of the bottom side of the tongue rail with a possibility of machining of the 45° chamfer on the bottom. Usage of rigid tangential inserts with 8 cutting edges makes the cutting process productive and reliable.



J(T)-SXP16, Long Edge Chamfer Milling Cutter with Coolant Through

Chamfer milling cutter with single sided XPHT 16 inserts and APMX between 7 up to 28 mm. Suited for top chamfering. Available in arbor mounting only. Outside \varnothing 35 and \varnothing 45 mm, in range of 15°, 25°, 30°, 35°, 40°, 45°, 50°, 55°, and 60° chamfer angle.

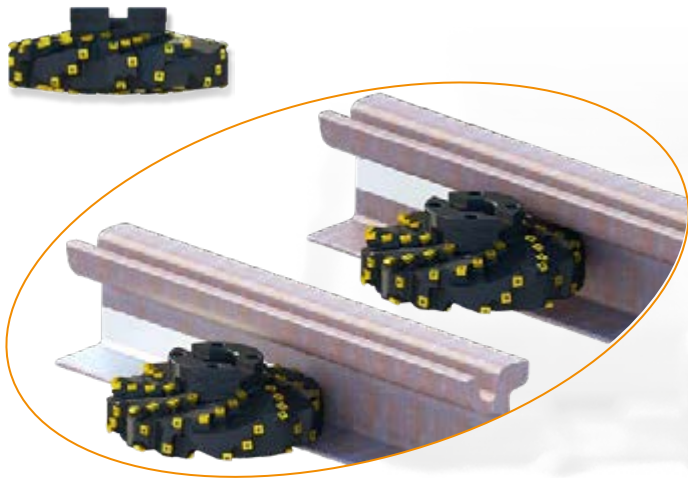

Special profile milling cutter for machining of the tram rail web in two steps

∅ 300 mm cutter for machining of the rail web, radii R10, fillet with taper 1:5 and the top of the base with taper 1:10. All is done in two steps. Milling cutter has 4 effective teeth by using square tangential inserts with 8 cutting edges and square tangential inserts with 2 cutting edges.



Special profile milling cutter for machining of the tram rail web and the side of the head in two steps

∅ 280 mm cutter for machining of the side of the rail head with taper 1:6, radius R35, rail web radii R10, fillet with taper 1:5 and the top of the base with taper 1:10. All is done in two steps. Milling cutter has 4 effective teeth by using square tangential inserts with 8 cutting edges and square tangential inserts with 2 or 4 cutting edges.

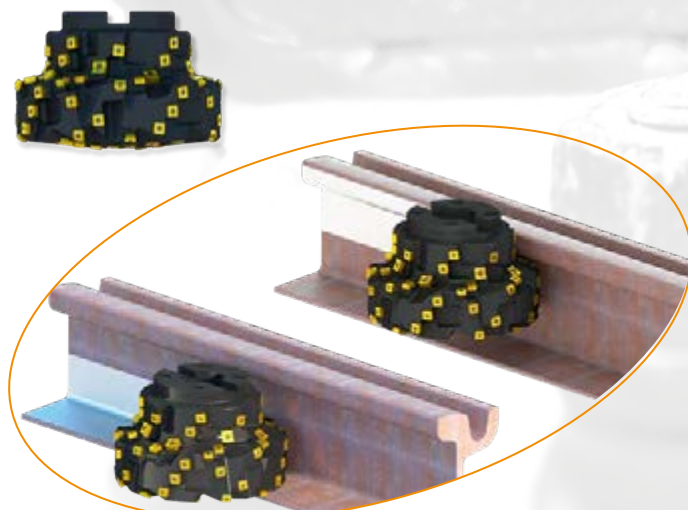

Special profile milling cutter for machining of the tram rail web in two steps

∅ 240 mm cutter for machining of the side of the rail head with 90° wall, radius R15, rail web radii R10, fillet with taper 1:5 and the top of the base with taper 1:10. All is done in two steps. Milling cutter has 4 effective teeth by using square tangential inserts with 8 cutting edges and square tangential inserts with 2 or 4 cutting edges.

Special profile milling cutter for machining of the side of the crossing's block

The cutter is assembled out of two pieces with the minimum \varnothing 90 mm and maximum \varnothing 165 mm. Milling cutter can be held from both sides that brings the possibility to use the cutter as the right-hand and left-hand version.



Special profile milling cutter for machining of the side and bottom of the crossing's block

Milling cutter with the maximum \varnothing 220 mm for machining of tapered sides of the crossing's block and for machining of the 90° wall in the bottom part. Square shaped rigid tangential inserts with 8 cutting edges and 4 cutting edges on radius inserts ensure high material removal rate.



Special tapered corner radius cutter for machining of the crossing's block groove

Shank style milling cutter for machining of the tapered groove sides (inclination 1:4) and fillet radius R10. Minimum cutter \varnothing 27.5 mm and APMX of 27 mm.

Special profile milling cutter for machining of the heel (distance) blocks

The cutter is assembled out of three parts with the minimum \varnothing 109 mm and maximum \varnothing 165 mm. Cutter is used for machining of the middle part (90°) and two tapered surfaces (1:3) on the heel block but it also has protective inserts in case of extra material in reliefs.





MACHINING OF SWITCH RODS

Special profile milling cutter for machining of switch rod

Profile milling cutter with maximum \varnothing 200 mm for machining of fillet radius R5 and outer radii R150 mm, respectively R200 mm. Cutter is equipped with rigid tangential inserts with 8 or 4 cutting edges that ensure high material removal rate.

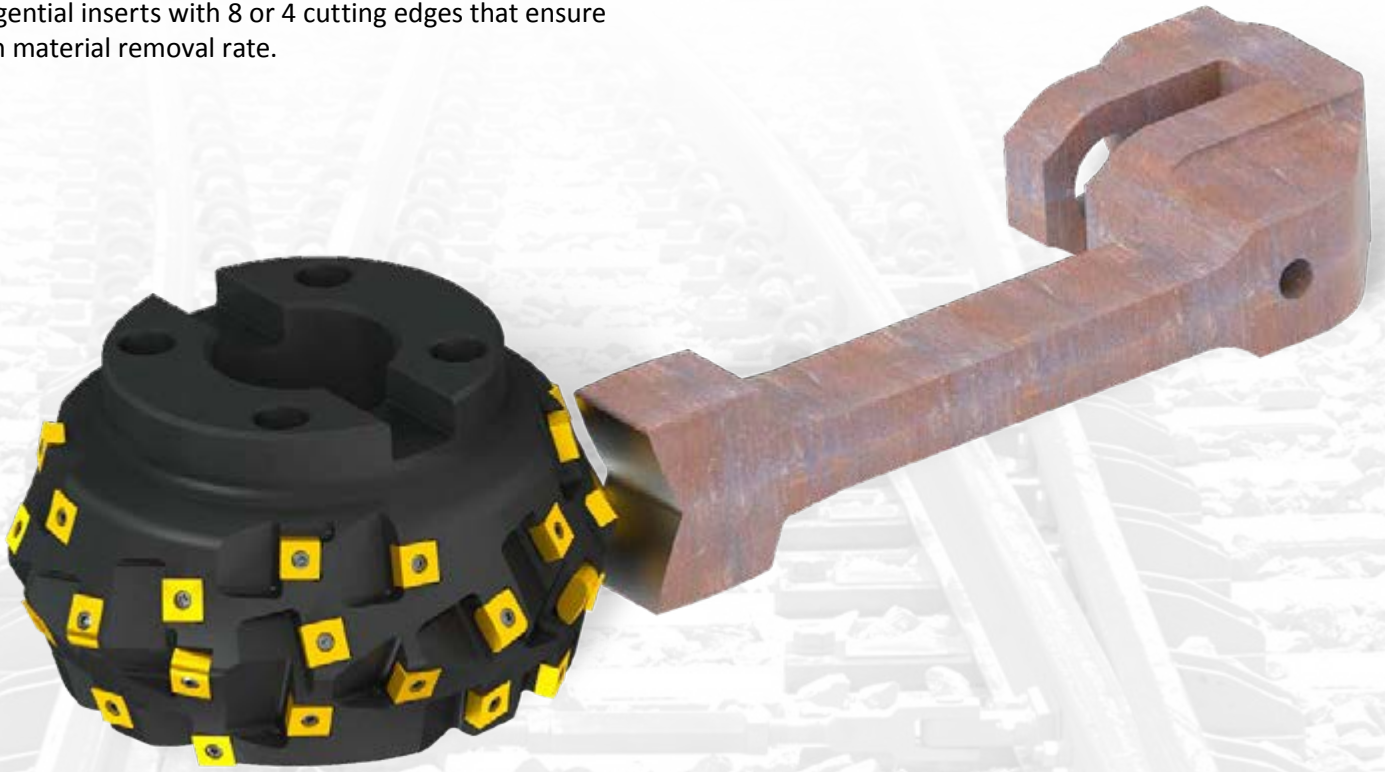

Special shank style milling cutter with inverted taper shape

Cutter \varnothing 49 mm with maximum APMX of 32 mm is equipped with strong tangential insert for machining of the corner radius R3 and with radial standard inserts with sharp geometry for a smooth cutting process. Cutter is machining an inverted tapered wall with a 70° (1:2.75) inclination.

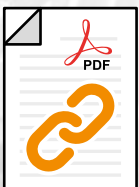



BASE PLATES MACHINING



BASE PLATES

Base plates, also called sole plates or tie plates, are used to fix the rail to the sleeper. These plates increase bearing area and holds the rail to the correct gauge.

Base plates are fastened by the bolts or spikes to the sleeper. The rail is attached to the plate by a system of clips or clamps, depending on the design. To avoid the vibration and to reduce the noise the rubber pad is used between the rail and the base plate as well as between the base plate and the sleeper. The part of the plate under the rail can be flat but often it is tapered 1:X (1:20, 1:40, ...) so both the rails in the track are inclined to the track center.

The base plates are produced from the long rolled stripe with pre-rolled ribs. The cutting of the rolled stripe is then done by shearing or sawing. The holes are punched or drilled and the slot for T-head bolt is done by milling. Base plates are made of steel S275JR with a content of C 0.21 %, the tensile strength is 410 up to 560 Mpa.

Dormer Pramet offers a wide range of standard tools for face milling, slot machining and drilling operations and special tools that are need to be used for machining of the dove-tail groove for the T-head bolt.

Grades first choices for machining of base plates are M8326, M8340 in the milling area and D8330, D8345 for drilling applications.

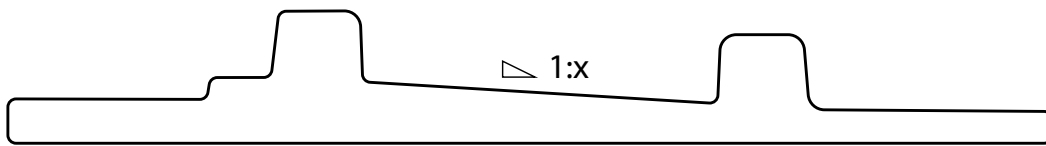



MACHINING OF BASE PLATES – BOTTOM PART

SPN13, PENTA HD Face Mill, Double Negative for Heavy Face Milling

High productive 57° face mill for double sided PN.. 13 and XN.. 13 style inserts with max. cutting depth APMX of 10 mm. Suited for face milling. Arbor mounting only, in range from ϕ 100 up to ϕ 315 mm. Insert seat protected with shim. Easy insert exchange.



SHN06C and SHN09C, ECON HN, 45° Face Mill with Double Negative Design and Internal Coolant

Highly productive 45° face mill utilising double sided HN.. 06 style inserts with APMX of 3 mm. Roughing, finishing and chamfering. Economical insert with 12 cutting edges. Differential tooth pitch. SHN06C: Weldon, screw and arbor mounting available, in range from ϕ 25 up to ϕ 125 mm. SHN09C: Arbor mounting only, in range from ϕ 50 up to ϕ 315 mm.

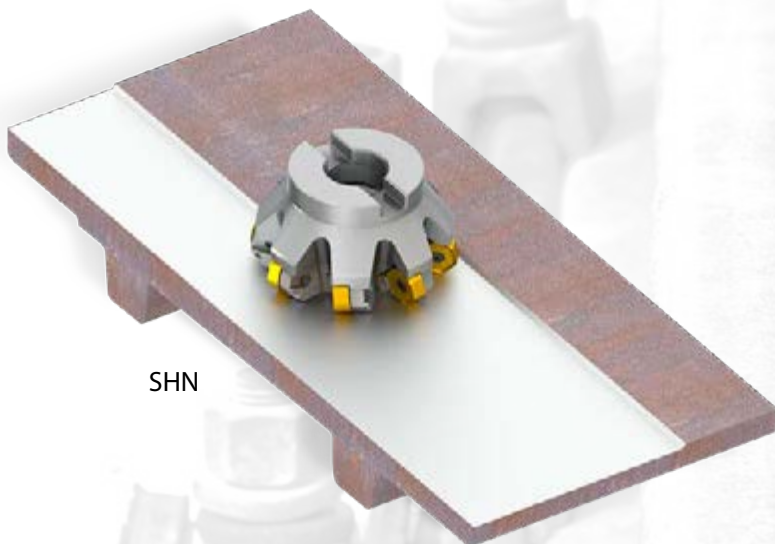

SRD12 and SRD16, Copy Milling Cutter for Round Inserts Size 12 and 16 with Coolant Through

Milling cutter for profile and copy milling with positive RD.. 12 and 16 inserts and APMX of 3 mm and 4 mm. Suitable for face, helical interpolated, ramping, progressive plunge, copy, and profile milling. SRD12 available in modular and arbor mounting, in range ϕ 24 up to ϕ 80 mm. SRD16 available in modular and arbor mounting, in range ϕ 32 up to ϕ 100 mm.



SRD12, 16



MACHINING OF BASE PLATES – ROUGHING OF THE GROOVE

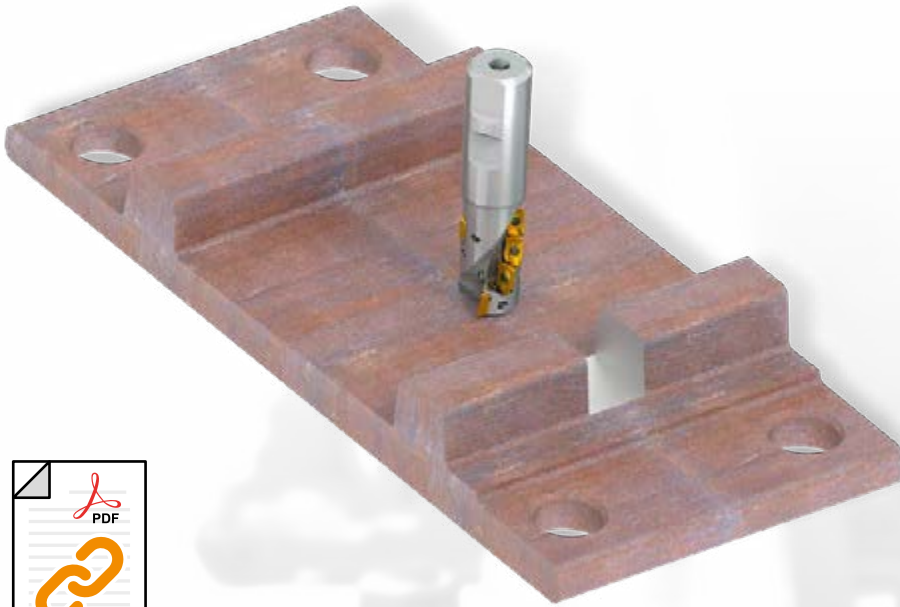

J(T)-SAD11E

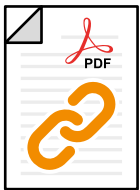

J(T)-SAD11E, FORCE AD Long Edge End Mill for ADMX Insert for Medium Milling

90° long edge end mill for positive ADMX 11 inserts with APMX of 37 up to 56 mm with coolant through. Suited for shoulder, slot, face, or plunge milling. Available in weldon, morse and arbor mounting only, in \varnothing 25 up to \varnothing 50 mm.

S90CN(XN), Side and Face Disk Milling Cutter with adjustable Cutter Width

90° side and face cutter for SNHX 12 inserts and APMX of 16 up to 50 mm depth and adjustable CW of 14 up to 30.5 mm cutter width. Suited for shoulder, slot, face, or face milling. Available in arbor or stub arbor mounting, in range \varnothing 125 up to \varnothing 315 mm.

S90SN, Side and Face Disk Milling Cutter

90° side and face cutter for SNHX 12 inserts and APMX of 16 up to 50 mm slotting depth and CW of 4 up to 14 slotting width. Suited for shoulder, slot, face, or face milling. Available in arbor or stub arbor mounting, in range \varnothing 63 up to \varnothing 200 mm.

S90CN(XN)



S90SN





MACHINING OF BASE PLATES – ROUGHING OF THE GROOVE



S710, 2-Flute Solid Carbide End Mill

Medium 2-flute design with 40° helix provides high rigidity for milling standard slots. AlCrN coating increases service life and improves performance. For plunging, ramping and profile milling. Available in range from \varnothing 1 up to \varnothing 20 mm with APMX from 3 mm up to 38 mm.

S812HA, 2-Flute Solid Carbide Slot End Mill, DIN 6536HA Shank

Medium length 2-flute design provides high rigidity for milling standard slots to a P9 tolerance. Alcrona coating increases service life and improves performance. For plunging, ramping and profile milling. Available in range from \varnothing 2 up to \varnothing 20 mm with APMX from 6 mm up to 32 mm.

S822, 2-Flute Solid Carbide Slot End Mill

Longer length 2-flute design provides high rigidity for milling standard slots to a P9 tolerance. Alcrona coating increases service life and improves performance. For plunging, ramping and profile milling. Available in range from \varnothing 2 up to \varnothing 20 mm with APMX from 8 mm up to 38 mm.

S922, 2-Flute Solid Carbide Slot Mill, DIN 6535HB Shank

Medium length 2-flute design provides high rigidity for milling standard slots to a H10 tolerance. A TiAlN coating for higher temperature resistance and longer tool life. For plunging, ramping and slot milling. Economical range of milling cutters with weldon shank. Available in range from \varnothing 2 up to \varnothing 20 mm with APMX from 6 mm up to 38 mm.

C135, 2-Flute HSS-E Long Reach Slot Drill / Milling Cutter, DIN 1835B Shank

Long reach 2-flute design provides high rigidity for milling standard keyway slots to a P9 tolerance. Provides increased strength and reduced vibration in difficult to reach areas. Can be used for plunging, ramping and profile milling. Available in range from \varnothing 2 up to \varnothing 20 mm with APMX from 7 mm up to 38 mm.



MACHINING OF BASE PLATES – DOVE-TAIL GROOVE

C825, HSS-E Side and Face Cutter / Milling Cutter, Weldon Shank

Versatile side and face cutters for grooving and slot milling. The Weldon shank provides accurate and stable holding whilst the side and face milling head makes the tools good for creating slots in vertical walls. Bright finish. Available in range from \varnothing 40 up to \varnothing 63 mm with APMX from 3 mm up to 16 mm.

1 – Special T-slot milling cutter with positive inserts

Shank style milling cutter \varnothing 42 mm for machining of the T-slot with APMX of 10 mm. Standard positive SOMT 09T3 inserts for smooth cutting process.



C825

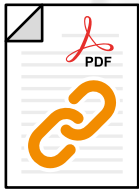

2 – Roughing dove tail cutter

Shank style milling cutter \varnothing 45 mm for roughing of the dove tail shape groove. Usage of standard positive SOMT 09T3 and special tangential LDEX 12 inserts.

3 – Left-handed finishing dove tail cutter

Shank style milling cutter \varnothing 57 mm that makes the full shape of the groove together with 90° wall on the groove sides.

4 – Left-handed finishing dove tail cutter

Shank style milling cutter \varnothing 57 mm that makes the full shape of the groove together with 90° wall on the groove sides and chamfer on the top edges.

5 – Special step-drills

Step drills with various diameters for drilling of the mounting holes in base plates. Drill can do the machining of the chamfer on the top as well as on the bottom by circular interpolation.

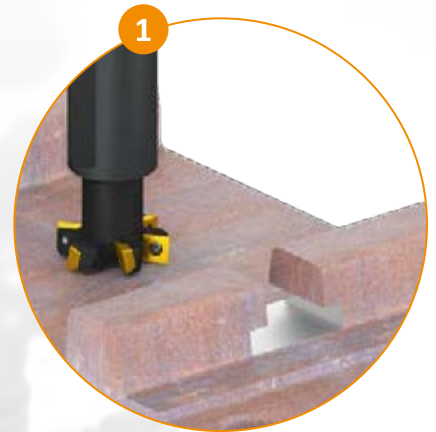

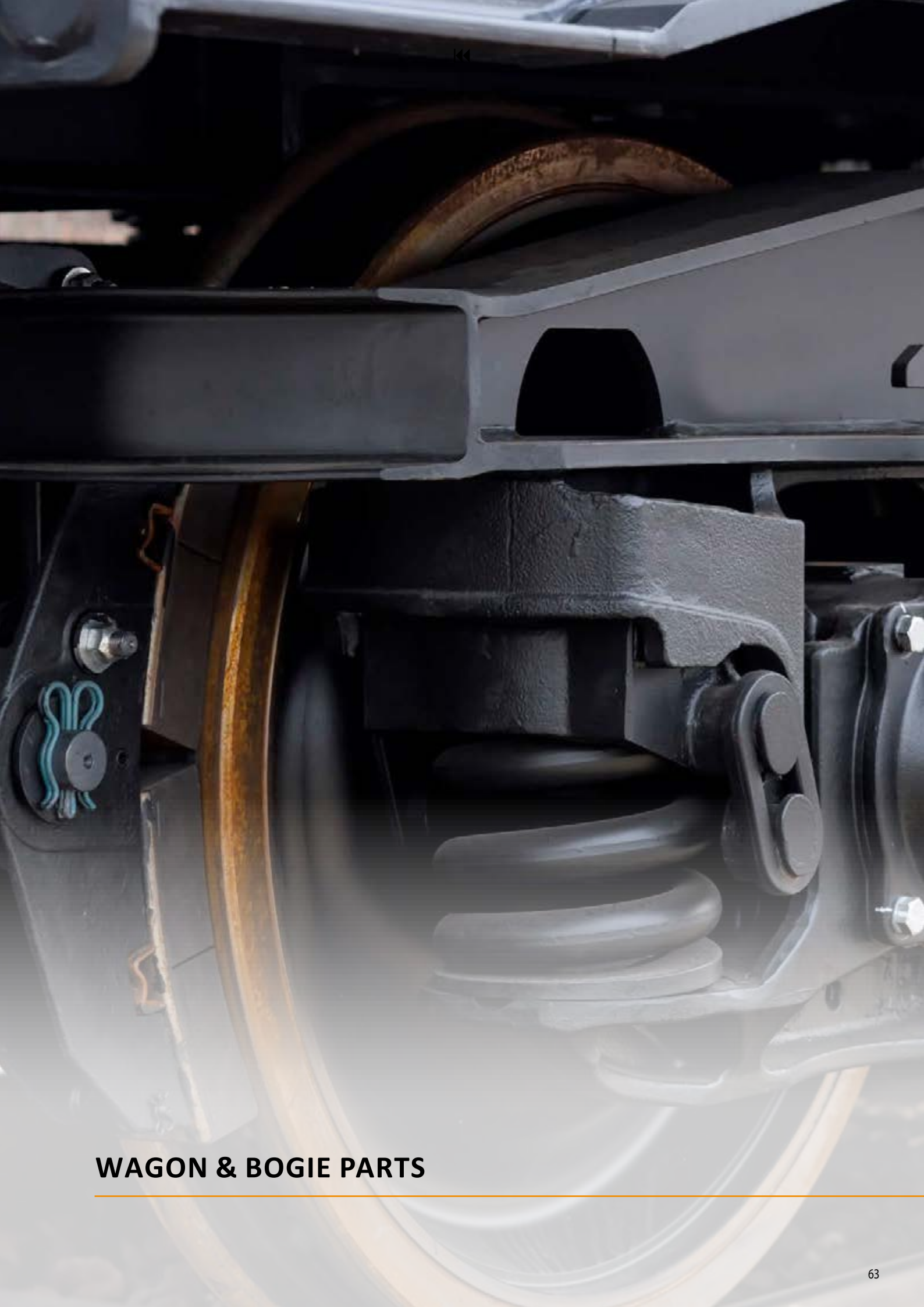

WAGON & BOGIE PARTS



WAGON PARTS

Round tools for drilling, tapping and deburring operations on various wagon parts such as wagon frames and bogies. You can find a high variety of different geometries and grades of our tools for different kind of work-piece materials and applications.

Hydra

Interchangeable solid carbide head drills for high performance machining of steels, stainless steels and cast iron. Fail-safe head location can be changed without ejecting the drill from the machine. Available with coolant feed and a choice of HSS bodies from 1.5xD for improved rigidity in shallow hole and plate drilling, through to 12xD for deeper hole applications.

Force drills – X, M, N

FORCE X carbide drills are developed for high performance machining applications in a wide variety of work-materials such as Carbon and Alloy Steels up to 1500 MPa and Cast-Iron. FORCE X drills also perform well in Stainless Steel and Aluminum making them an ideal first choice for subcontract machining companies.

FORCE M carbide drills have been engineered to provide the highest performance and process reliability when drilling Stainless steels and Heat resistant super alloys. FORCE M drills are ideal for applications where it is necessary to drill a large number of holes with high and constant accuracy.

FORCE N carbide drills are recommended for high-speed drilling operations in wrought and cast aluminum alloys. The flute and cutting geometry are specifically designed to break the swarf into small manageable chips to enhance chip evacuation. FORCE N drills provide superior performance and tool life for mid-high volume manufacturing companies.

(for more information see Dormer Pramet Holemaking catalogue)



Shark taps

Dormer's application-based ranges of DIN taps, branded Shark Line, are renowned for their high performance and are easily recognizable by their colored rings, denoting recommendation for use on specific materials. *(for more information see Dormer Pramet Threading catalogue)*



Carbide rotary burrs

Our range of carbide rotary burrs is a high quality and comprehensive program. This includes a variety of designs and shapes to offer an ideal option for the majority of applications in all major industry segments.





MACHINING OF BOGIE PARTS – INDEXABLE TOOLS

Standard square shoulder-, face- and high feed milling cutters and drilling tools for machining of side frames, bolsters, bearing houses and other bogie parts.

J(T)-SAD16E, HELICAL AD, Long Edge End Mill for AD.. Insert for Medium Milling

900 long edge end mill for positive AD.. 16 inserts with APMX of 40 up to 108 mm with coolant through. Suited for shoulder, slot, face or plunge milling. Available in arbor, ISO, BT and 2080 taper mounting, in ϕ 50 up to ϕ 100 mm. Available with differential tooth setting.



HELICAL AD



FORCE AD16

FORCE AD16 Square Shoulder Mill with Internal Coolant

900 end and shell mills utilizing positive AD.. 16 style insert with APMX of 13 mm. Suitable for face, shoulder, slot, helical, trochoidal, ramping and plunge milling. Available in cylindrical, weldon, morse taper, modular and arbor (with differential tooth pitch) style, in ϕ 25 up to ϕ 175 mm.



FEED ZD, High-Feed Milling Cutter with Coolant Through

High productive high-feed milling cutter with double sided ZD.. 07; ZD.. 09 or ZD.. 12 insert with 8 cutting edges and a APMX of 1.0 up to 1.6 mm. Suited for a wide range of applications. Available in cylindrical, modular and arbor mounting, in range of ϕ 16 up to ϕ 80 mm.



FEED ZD



Indexable Insert Drill with Internal Coolant Feed

High performance indexable insert drill for drilling blind and trough holes and potentially cross-, off center-, helical and stacked material drilling, plunging, drilling on concave or sloped surfaces, drilling with interrupted cuts, chamfer drilling and even boring type drilling. Available from ϕ 15 up to ϕ 40 mm in 2xD, from ϕ 15 up to ϕ 58 mm in 3xD, from ϕ 17 up to ϕ 58 mm in 4xD and from ϕ 19 up to ϕ 31 mm in 5xD.



ECON HN

SHN06C and SHN09C, ECON HN, 45° Face Mill with Double Negative Design and Internal Coolant

Highly productive 45° face mill utilizing double sided HN.. 06 or HN.. 09 style inserts with APMX of 3 mm and 5 mm. Roughing, finishing and chamfering. Economical insert with 12 cutting edges. Differential tooth pitch. SHN06C: Weldon, screw and arbor mounting available, in range from ϕ 25 up to ϕ 125 mm. SHN09C: Arbor mounting only, in range from ϕ 50 up to ϕ 315 mm.

The comprehensive range of technology we offer for the machining of couplers is an example of our capabilities in the wagon production segment.

1 – Special porcupine milling cutter

ø 100 mm cutter, for machining of the walls with high APMX up to 150 mm. Productive solution due to the strong body design with 4 effective teeth and tangential inserts usage.

2 – Special porcupine milling cutter for milling in narrow slots

Milling cutter with ø 36 mm and APMX of 70 mm for milling of the 90° walls in narrow slots. Tangential inserts with chip-breaker must be used because of the long tool overhang.

3 – Special step drill

Drilling of ø 32 mm and ø 50 mm together with finishing of the top face with maximum ø 100 mm. Strong and rigid solid body design with usage of standard drilling inserts. Maximum hole depth 145 mm.

4 – Special tapered mono-block cutter – 70°

Milling cutter ø 77 mm with APMX of 70 mm for machining of the tapered 70° wall and the bottom surface.

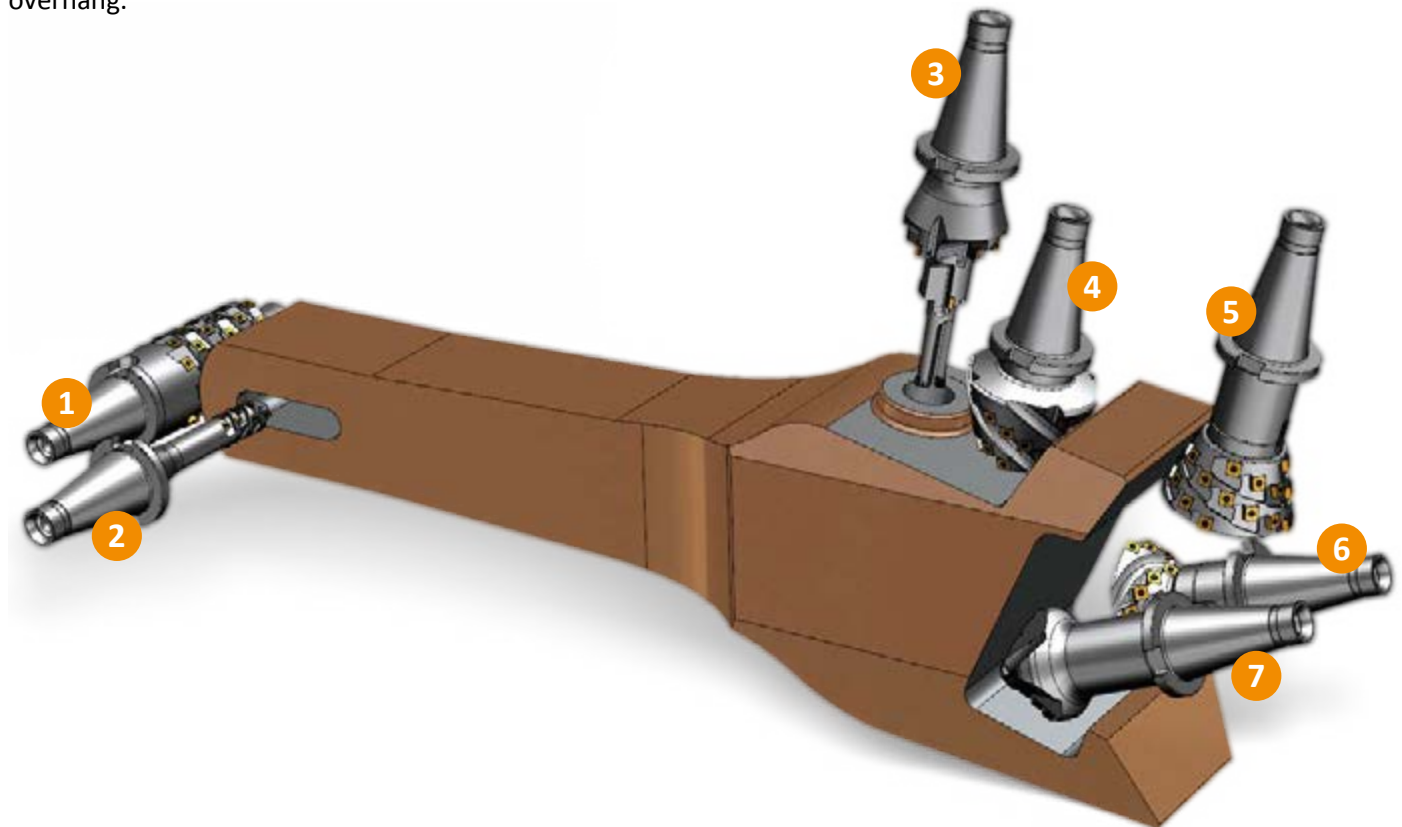

5 – Special inverted tapered milling cutter – 108°

Milling cutter for machining of inverted tapered surfaces with an angle of 108°. Maximum ø 130 mm and APMX of 65 mm. Cutter is equipped with rigid tangential inserts with 8 cutting edges. Smooth helix ensures the soft cut.

6 – Special inverted tapered milling cutter – 131°

Milling cutter for machining of inverted tapered surfaces with an angle of 131°. Maximum ø 138 mm and APMX of 40 mm. Cutter is equipped with rigid tangential inserts with 8 cutting edges. Smooth helix ensures the soft cutting process.

7 – Special tapered mono-block cutter – 47°

Special tapered milling cutter with minimum ø 15 mm and APMX of 46 mm. Standard, sharp, radial inserts and large flutes ensure the smooth cutting process and easy chips evacuation.



DORMER PRAMET



ALL TOOLS TOGETHER

Our entire assortment of rounds tools and indexables is included within the machining calculator app. That's more than **40,000** items! Whatever your machining we're likely to have something for it. **Simply Reliable.**

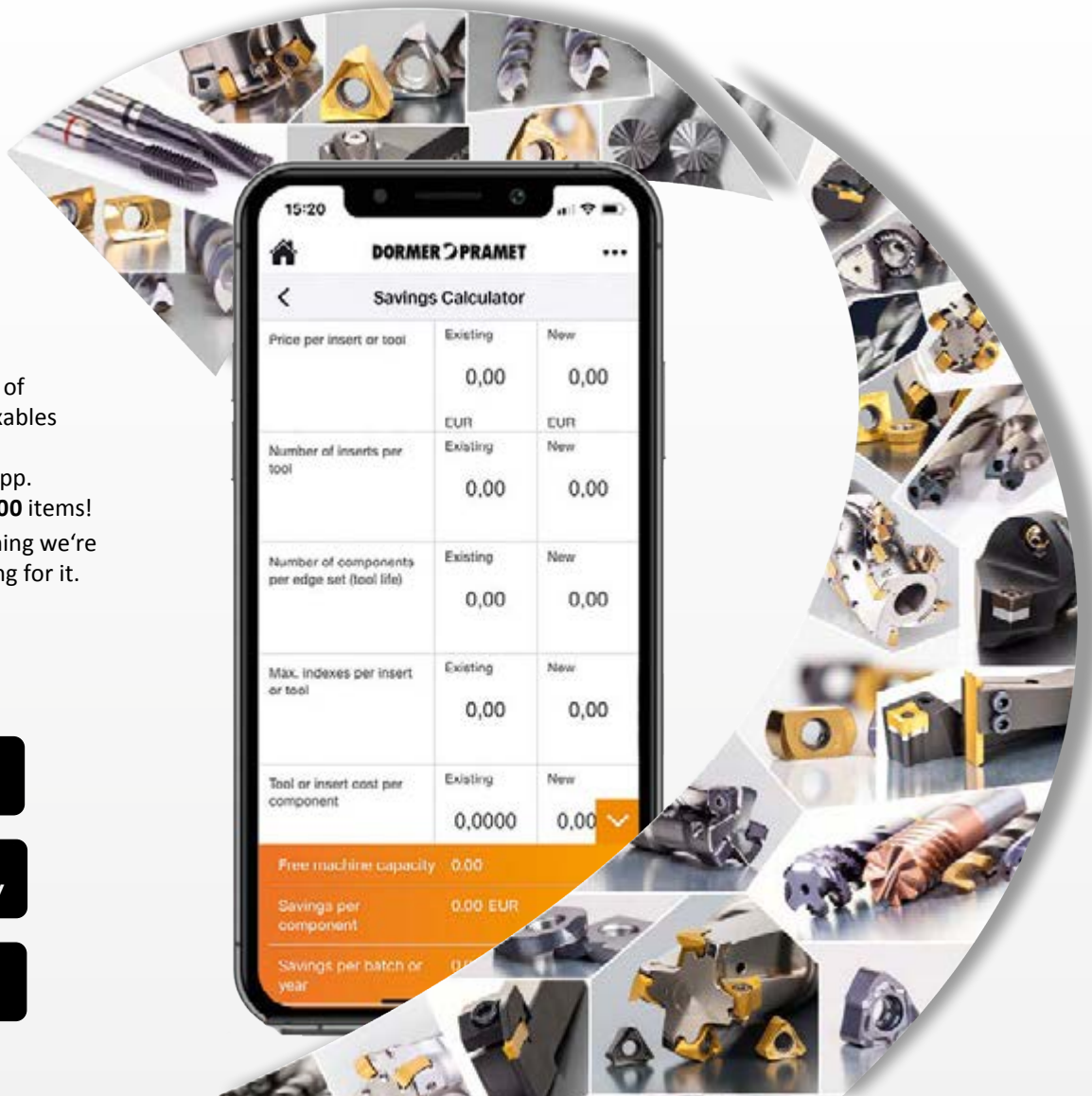



WORKPIECE MATERIAL GROUPS (WMG)

ISO To select a cutting grade and geometry for a broad range of workpiece materials

General definition
i.e. Steel, Stainless Steel...

P **M** **K** **N** **S** **H**

Subgroup To navigate and select a tool by suitability for a more specific range of workpiece materials

Definition by structure/composition
i.e. Plain Carbon Steel, Alloy Steel...

P **M** **K** **N** **S** **H**

P1

P2

P3

P4

WMG To select and provide cutting conditions within a bandwidth of $\pm 10\%$

Definition by hardness/ultimate tensile strength
i.e. $160 < 220$ HB, $620 < 900$ N/mm² ...

P

P1 **P1.1** **P1.2** **P1.3**

P2 **P2.1** **P2.2** **P2.3**

P3 **P3.1** **P3.2** **P3.3**

P4 **P4.1** **P4.2** **P4.3**

ABOUT DORMER PRAMET'S WORKPIECE MATERIAL CLASSIFICATION

Workpiece **Material Groups (WMG)** are used to support easy and reliable selection of the right cutting tool and starting values for machining conditions in particular applications.

Dormer Pramet classifies workpiece materials into six different coloured groups;

- **Blue:** Steel and cast steel (P-group)
- **Yellow:** Stainless steel (M-group)
- **Red:** Cast iron (K-group)
- **Green:** Non-ferrous metals (N-group)
- **Brown:** High-temperature alloys (S-group)
- **Grey:** Hardened materials (H-group)

Each of these are divided into subgroups on the basis of their structure and/or composition. For example, P-group steel and cast steel is split into four subgroups, namely;

- **P1** – Free machining steel
- **P2** – Plain carbon steel
- **P3** – Alloy steel
- **P4** – Tool steel

A final division includes material properties, such as hardness and ultimate tensile strength. This is to provide our customers with a complete tool recommendation, including starting values for cutting speed and feed.

The table on the next page includes a description of each workpiece material group, as well as examples of commonly used designations.



WMG (WORK MATERIAL GROUP)

ISO group	WMG (Work Material Group)	Hardness (HB or HRC)	Ultimate Tensile Strength (MPa)					
P	P1	P1.1	Sulfurized	< 240 HB	≤ 830			
		P1.2	Free machining steel (carbon steels with increased machinability)	Sulfurized and phosphorized	< 180 HB	≤ 620		
		P1.3		Sulfurized/phosphorized and leaded	< 180 HB	≤ 620		
	P2	P2.1	Plain carbon steel (steels comprised of mainly iron and carbon)	Containing <0.25 % C	< 180 HB	≤ 620		
		P2.2		Containing <0.55 % C	< 240 HB	≤ 830		
		P2.3		Containing >0.55 % C	< 300 HB	≤ 1030		
	P3	P3.1	Alloy steel (carbon steels with an alloying content ≤ 10%)	Annealed	< 180 HB	≤ 620		
		P3.2		Hardened and tempered	180 – 260 HB	> 620 ≤ 900		
		P3.3			260 – 360 HB	> 900 ≤ 1240		
	P4	P4.1	Tool steel (special alloy steel for tools, dies and molds)	Annealed	< 26 HRC	≤ 900		
P4.2		Hardened and tempered		26 – 39 HRC	> 900 ≤ 1240			
P4.3				39 – 45 HRC	> 1240 ≤ 1450			
M	M1	M1.1	Ferritic stainless steel (straight chromium non-hardenable alloys)	< 160 HB	≤ 520			
				160 – 220 HB	> 520 ≤ 700			
	M2	M2.1	Martensitic stainless steel (straight chromium hardenable alloys)	Annealed	< 200 HB	≤ 670		
				Quenched and tempered	200 – 280 HB	> 670 ≤ 950		
				Precipitation-hardened	280 – 380 HB	> 950 ≤ 1300		
	M3	M3.1	Austenitic stainless steel (chromium-nickel and chromium-nickel-manganese alloys)	< 200 HB	≤ 750			
				200 – 260 HB	> 750 ≤ 870			
				260 – 300 HB	> 870 ≤ 1040			
	M4	M4.1	Austenitic-ferritic (DUPLEX) or super-austenitic stainless steel	< 300 HB	≤ 990			
		M4.2	Precipitation hardening austenitic stainless steel	300 – 380 HB	≤ 1320			
K	K1	K1.1	Gray iron or Automotive Gray iron (GG) (iron-carbon castings with a lamellar graphite microstructure)	Ferritic or ferritic-pearlitic	< 180 HB	≤ 190		
				Ferritic-pearlitic or pearlitic	180 – 240 HB	> 190 ≤ 310		
				Pearlitic	240 – 280 HB	> 310 ≤ 390		
	K2	K2.1	Malleable iron (GTS/GTW) (iron-carbon castings with a graphite-free microstructure)	Ferritic	< 160 HB	≤ 400		
				Ferritic or pearlitic	160 – 200 HB	> 400 ≤ 550		
				Pearlitic	200 – 240 HB	> 550 ≤ 660		
	K3	K3.1	Ductile iron (GGG) (iron-carbon castings with a nodular graphite microstructure)	Ferritic	< 180 HB	≤ 560		
				Ferritic or pearlitic	180 – 220 HB	> 560 ≤ 680		
				Pearlitic	220 – 260 HB	> 680 ≤ 800		
	K4	K4.1	Austenitic gray iron (ASTM A436) (iron-carbon alloy castings with an austenitic lamellar graphite microstructure)	< 180 HB	≤ 190			
				< 240 HB	≤ 740			
		K4.2	Austenitic ductile iron (ASTM A439 or ASTM A571) (iron-carbon alloy castings with an austenitic nodular graphite microstructure)	< 280 HB	> 840 ≤ 980			
				280 – 320 HB	> 980 ≤ 1130			
320 – 360 HB				> 1130 ≤ 1280				
K5	K5.1	Compacted graphite iron CGI (ASTM A842) (iron-carbon castings with a vermicular graphite structure)	Ferritic	< 180 HB	≤ 400			
			Ferritic-pearlitic	180 – 220 HB	> 400 ≤ 450			
			Pearlitic	220 – 260 HB	> 450 ≤ 500			
N	N1	N1.1	Commercially pure wrought aluminium	< 60 HB	≤ 240			
				N1.2	Wrought aluminium alloys	Half hard tempered	60 – 100 HB	> 240 ≤ 400
						Full hard tempered	100 – 150 HB	> 400 ≤ 590
	N2	N2.1	Cast aluminium alloys	< 75 HB	≤ 240			
				75 – 90 HB	> 240 ≤ 270			
				90 – 140 HB	> 270 ≤ 440			
	N3	N3.1	Free-cutting copper-alloys materials with excellent machining properties	–	–			
				N3.2	Short-chip copper-alloys with good to moderate machining properties	–	–	
						N3.3	Electrolytic copper and long-chip copper-alloys with moderate to poor machining properties	–
	N4	N4.1	Thermoplastic polymers	–	–			
N4.2				Thermosetting polymers	–	–		
					N4.3	Reinforced polymers or composites	–	–
N5	N5.1	Graphite	–	–				
S	S1	S1.1	Titanium or titanium alloys	< 200 HB	≤ 660			
				200 – 280 HB	> 660 ≤ 950			
				280 – 360 HB	> 950 ≤ 1200			
	S2	S2.1	Fe-based high-temperature alloys	< 200 HB	≤ 690			
				200 – 280 HB	> 690 ≤ 970			
	S3	S3.1	Ni-based high-temperature alloys	< 280 HB	≤ 940			
				280 – 360 HB	> 940 ≤ 1200			
	S4	S4.1	Co-based high-temperature alloys	< 240 HB	≤ 800			
240 – 320 HB				> 800 ≤ 1070				
H	H1	H1.1	Chilled cast iron	< 440 HB	–			
				< 55 HRC	–			
	H2	H2.1	Hardened cast iron	> 55 HRC	–			
				< 51 HRC	–			
	H3	H3.1	Hardened steel < 55 HRC	51 – 55 HRC	–			
				> 59 HRC	–			
	H4	H4.1	Hardened steel > 55 HRC	55 – 59 HRC	–			
				> 59 HRC	–			



RAILWAY – TURNING ASSORTMENT



**CONTENT**

7		INTRODUCTION & ASSORTMENT HIGHLIGHTS
13	RAILWAY INDUSTRY	PRODUCTION OF NEW RAILWAY WHEELS
20		RAILWAY WHEEL RECONDITIONING
26		AXLES MACHINING
30		STATIONARY & DYNAMIC RAIL MILLING
37		TURNOUTS MACHINING
57		BASE PLATES MACHINING
63		WAGON & BOGIE PARTS MACHINING
73		TURNING ASSORTMENT
92	POSITIVE INSERTS	
129	NEGATIVE INSERTS	
248	MILLING ASSORTMENT	SOLID HM & HSS MILLS
269		ROTARY BURRS
289		INDEXABLE MILLS
433	HOLEMAKING ASSORTMENT	SOLID CARBIDE & HSS DRILLS
456		REAMERS & COUNTERSINKS
477		EXCHANGEABLE HEAD INDEXABLE DRILLS
533	THEARDING ASSORTMENT	MATERIAL SPECIFIC & HSS TAPS
548		TECHNICAL PART



DORMER PRAMET



QUICK SEARCH

Easily and quickly perform a text search within any publication launched by Dormer Pramet in recent time through our library app. Download it today from your relevant app store. **Simply Reliable.**

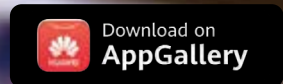



CUTTING TOOL PARAMETERS ACCORDING TO ISO 13399

All cutting tools are defined by a number of parameters according to the standard ISO 13399. This list contains all the parameters used in this catalogue and their definitions.

ISO 13399 is an international cutting tool information standard. It provides dimensions and parameters in a neutral format that is independent of any particular system or company nomenclature. When cutting tools are clearly defined according to a global standard, all types of software can process the electronic data more quickly, improving the quality of communication and helping to make the exchange of information run smoothly. Supporting a common language in our cutting tool descriptions this will assist system to system communication. It will save you a significant amount of time, providing an easier gathering of high-quality data across our 40,000 solid and indexable tools. By using an ISO 13399 compliant system, there will be no need to manually interpret data and key-enter it into your system.

EXAMPLES ONLY!

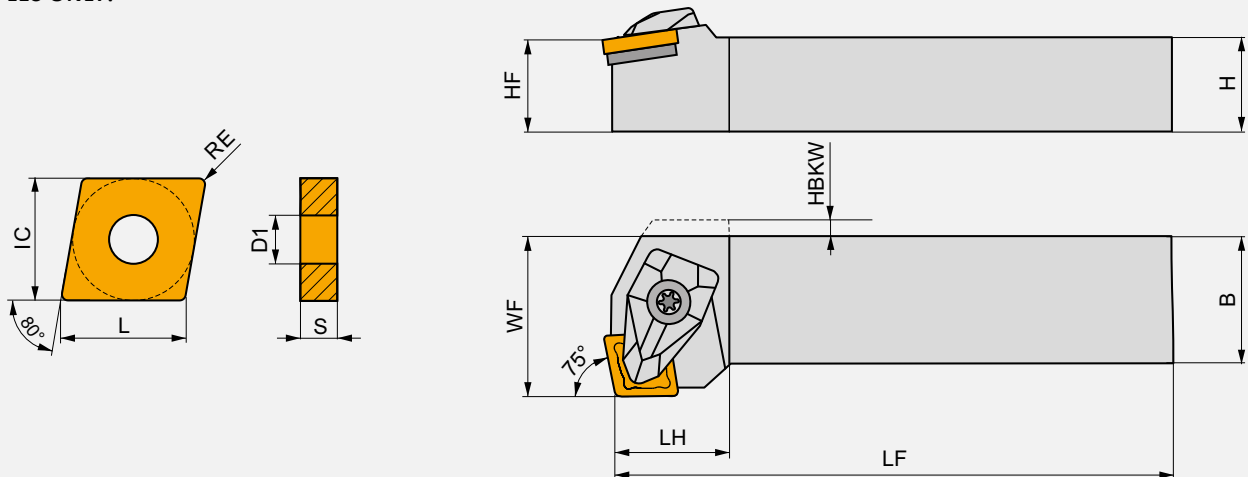

ISO 13399	Description
APMX	Depth of cut maximum
B	Shank width
BD	Body diameter
BLRAD	Blade reinforcement radius
BW	Insert body width
CDX	Cutting depth maximum
CND	Coolant entry diameter
CUTDIA	Work piece parting diameter maximum
CW	Cutting width
CWTOLL	Cutting width lower tolerance
CWTOLU	Cutting width upper tolerance
D1	Fixing hole diameter
DAXIN	Minimum axial groove inside diameter
DAXN	Minimum axial groove outside diameter
DAXX	Maximum axial groove outside diameter
DCON MS	Connection diameter
DMIN	Minimum bore diameter
DMINP	Minimum bore diameter perpendicular
GAMO	Orthogonal rake angle
GAMP	Axial rake angle
H	Shank height
HBH	Head bottom offset height
HBKW	Head bottom offset width
HF	Functional height
IC	Inscribed circle diameter
INSD	Insert diameter
INSL	Insert length

ISO 13399	Description
KAPR	Tool cutting edge angle
L	Cutting edge length
LAMS	Inclination angle
LB	Body length
LF	Functional length
LFA	A dimension on LF
LFS	Functional length secondary
LH	Head length
LU	Usable length
M	M-dimension
OAL	Overall length
PDX	Profile distance X
PDY	Profile distance Y
PSIRL	Tool lead angle left
PSIRR	Tool lead angle right
RE	Corner radius
S	Insert thickness
S1	Insert thickness total
TP	Thread pitch
TPI	Threads per inch
TPIN	Threads per inch
TPIX	Threads per inch
TPN	Thread pitch minimum
TPX	Thread pitch maximum
W1	Insert width
WF	Functional width
WFS	Functional width secondary



TURNING INSERTS – PAGE OVERVIEW



1 CNMM

	IC [mm]	D1 [mm]	L [mm]	S [mm]
1204	12.700	5.16	12.90	4.76
1606	15.875	6.35	16.10	6.35
1906	19.050	7.94	19.30	6.35
2509	25.400	9.12	25.80	9.53

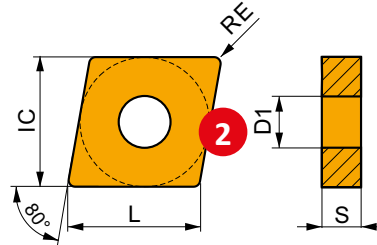

Suitability and starting values for cutting speed (vc), feed (f) and depth of cut (ap). Refer to our Machining Calculator app for further calculations.

Product	RE [mm]	P			M			K			N			S			H		
		vc [m/min]	f [mm/rev]	ap [mm]	vc [m/min]	f [mm/rev]	ap [mm]	vc [m/min]	f [mm/rev]	ap [mm]	vc [m/min]	f [mm/rev]	ap [mm]	vc [m/min]	f [mm/rev]	ap [mm]			

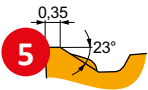

10 DR geometry for semi-rough to rough machining, and continuous to interrupted cuts.

CNMM 160612E-DR	T9315	1.2	225	0.45	6.0	–	–	–	210	0.45	6.0	–	–	–	–	–	–
	T9335	1.2	200	0.45	6.0	120	0.41	6.0	190	0.45	6.0	–	–	–	–	–	–
CNMM 190608E-DR	T9315	0.8	215	0.40	8.0	–	–	–	200	0.40	8.0	–	–	–	–	–	–
	T9325	0.8	190	0.40	8.0	110	0.36	8.0	180	0.40	8.0	–	–	–	–	–	–
CNMM 190612E-DR	T9315	1.2	220	0.45	8.0	–	–	–	205	0.45	8.0	–	–	–	–	–	–
	T9325	1.2	195	0.45	8.0	115	0.41	8.0	185	0.45	8.0	–	–	–	–	–	–
	T9335	1.2	170	0.45	8.0	100	0.41	8.0	–	–	–	–	–	–	–	–	–
CNMM 190616E-DR	T9325	1.6	195	0.50	9.0	115	0.45	9.0	185	0.50	9.0	–	–	–	–	–	–
	T9335	1.6	170	0.50	9.0	100	0.45	9.0	–	–	–	–	–	–	–	–	–

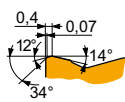

HR geometry for rough to heavy-rough machining, and continuous to interrupted cuts.

CNMM 190616E-HR	6640	1.6	75	0.60	10.0	45	0.54	10.0	70	0.60	10.0	–	–	–	–	–	–
	T8345	1.6	55	0.60	10.0	30	0.54	10.0	50	0.60	10.0	–	–	–	–	–	–
	T9325	1.6	105	0.60	10.0	60	0.54	10.0	95	0.60	10.0	–	–	–	–	–	–
	T9335	1.6	80	0.60	10.0	45	0.54	10.0	–	–	–	–	–	–	–	–	–

CNMM190616E-HR:T8345 Use full insert specification code when ordering!

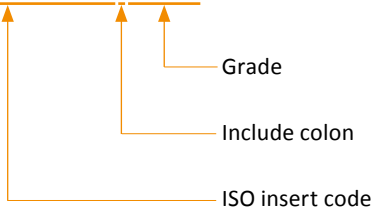



TURNING INSERTS – PAGE OVERVIEW

Pos.	Description	Pos.	Description
1	Designation of insert	7	ISO insert code
2	Schematic drawing of insert	8	Grade
3	Table with insert sizes (mm)	9	Insert radii (mm)
4	Picture of representative insert	10	Geometry description
5	Profile of main cutting edge	11	Application area of insert
6	Icons – specific features and cutting edge type		

1 **DDUN(RL) INT** **P** **M** **K** **N** **S** **I** **2** **PRAMET** **3** **D**



Internal Double Clamp Boring Bar with 93° Cutting Angle for DN.. Insert
 Internal Right/Left hand double clamp boring bar, through coolant, 93° cutting angle for DN.. 11 and 15 inserts. Minimum internal turning diameter Ø32 mm. Suited for wide range of internal turning applications, copy turning up to 27°. Available with shank size Ø25 up to Ø50 mm. Body treated for longer tool life.

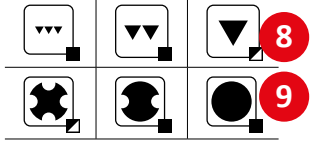
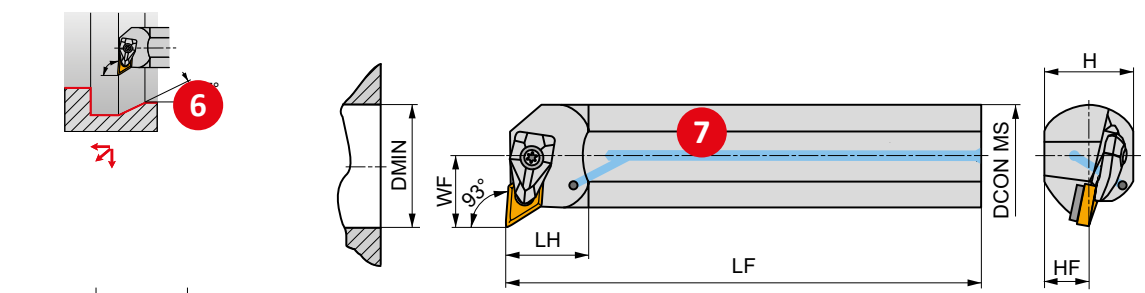

Product	DCON MS [mm]	DMIN [mm]	WF [mm]	H [mm]	HF [mm]	LF [mm]	LH [mm]	LAMS [°]	GAMO [°]	✓	kg	GI046	DD11	AT002
R A25T-DDUNR 11	25	32	17	23	11.5	300	28	-12	-6	✓	0.96	GI046	DD11	-
A32T-DDUNR 11	32	40	22	30	15	300	30	-10	-6	✓	1.68	GI046	DD11	-
A40T-DDUNR 15	40	50	27	37	18.5	300	36	-11	-6	✓	2.59	GI044	DD154	AT002
A50U-DDUNR 15	50	63	35	47	23.5	350	39	-8	-6	✓	5.25	GI044	DD154	AT002
L A25T-DDUNL 11	25	32	17	23	11.5	300	28	-12	-6	✓	0.96	GI046	DD11	-
A32T-DDUNL 11	32	40	22	30	15	300	30	-10	-6	✓	1.69	GI046	DD11	-
A40T-DDUNL 15	40	50	27	37	18.5	300	36	-11	-6	✓	2.59	GI044	DD154	AT002
A50U-DDUNL 15	50	63	35	47	23.5	350	39	-8	-6	✓	5.25	GI044	DD154	AT002

GI044	DN.. 1506..	19
GI046	DN.. 1104..	

DD11	DCS 09	1.7	DDS 267-01	US 2004-T09P	FLAG T09P	20
DD154	DCS 12	3.9	DDS 266-02	US 2002-T15P	FLAG T15P/3,5	

AT002a	DN.. 1504..	-	DDS 266-01	21
AT002b	CER DN.N 1506..	DCS 12C4	-	
AT002c	CER DN.A 1506..	DCS 12C2	-	



TURNING HOLDERS – PAGE OVERVIEW

Pos.	Description
1	Designation of turning holder
2	Material group recommendations
3	Clamping system of insert
4	Illustrative picture ¹⁾
5	Tool description
6	Workpiece profile
7	Schematic drawing of tool
8	Achievable quality of surface
9	Character of cut/working conditions
10	Product applications
11	Tool design

Pos.	Description
12	ISO code of holder
13	Dimensions (mm) and angles ²⁾ (°) of holder
14	Internal coolant supply
15	Weight (kg)
16	Group of compatible inserts ³⁾
17	Group of spare parts ^{3),4)}
18	Group of accessories ^{3),4)}
19	Compatible inserts
20	Spare parts
21	Special accessories

¹⁾ Turning holder is primarily displayed in its right design (R)

²⁾ GAMO = orthogonal rake angle (see technical pages)

LAMS = inclination angle of main cutting edge (see technical pages)

³⁾ Code of Group of compatible inserts, spare parts and special accessories is used only for purposes of this catalogue. It cannot be used for orders.

⁴⁾ Spare parts and special accessories icons are designed schematically for ease of understanding. They aren't included in list of icons. Screws are, in some cases, completed with info on torque value in Nm, length of screw and size of thread.



TURNING HOLDERS – ICONS OVERVIEW

GENERAL ICONS

	Primary use		Finishing – very good surface quality		Suitable for stable working conditions
	Possible use		Medium machining – good surface quality		Suitable for unstable working conditions
			Roughing – unlimited surface roughness		Suitable for very unstable working conditions

FEATURES

	First choice		Insert with Wiper geometry		Sharp edge
	For short chipping materials		Large overhang		Rounded edge
	For tough materials (long chipping)		Railway wheel machining		Edge with facet
	Heavy working conditions		Thin-walled and slim workpieces		Rounded edge with facet
	High Feed Cutting		Universal wide range option		Edge with double facet
	High Speed Cutting				Rounded edge with double facet





















TURNING OPERATIONS

	Cone turning – external		Chamfering (beveling)		Machining the rear face (shoulder) from the back
	Cone turning – internal		Chamfering (beveling) from the back		Multi directional copy turning – external
	Copy turning (multi directional machining)		Chamfering (beveling) in hole		Multi directional copy turning – internal
	Face copy turning		Longitudinal turning with shoulder – external		One directional copy turning – external
	Face copy turning in hole		Longitudinal turning with shoulder – internal		One directional copy turning – internal
	Face turning with shoulder		Longitudinal turning without shoulder – external		Shallow radial groove
	Face turning without shoulder		Longitudinal turning without shoulder – internal		



TURNING HOLDERS – ICONS OVERVIEW

TECHNICAL PAGES

	Fine finishing		Feed (mm/rev)		Very high cutting speed, excellent system rigidity (stable working conditions)
	Finishing		Durability (min)		High cutting speed, high system rigidity (stable working conditions)
	Medium machining		Grade		High cutting speed, system rigidity slightly limited (depth of cut changing)
	Roughing		Coating		Medium cutting speed, system rigidity limited (slightly interrupted cut)
	Heavy roughing		Cutting speed		Low cutting speed, low system rigidity (interrupted cut)
	Multiplication factor for cutting speed		Cutting edge profile		Very low cutting speed, very low system rigidity (very unstable working conditions)
	Depth of cut (mm)		Cooling		

OTHERS

	Clamping torque of screw (Nm)		Group of heads for roughing		Internal supply of coolant
---	-------------------------------	---	-----------------------------	---	----------------------------

ISO TURNING – EXTERNAL

LONG AND UNSTABLE COMPONENTS (positive inserts)

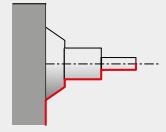

SRDCN EXT

		RC..
		06 08 10 12 16
	12×12 32×25	
	104	96 – 101

SRSC(RL) EXT

		RC..
		06 08 10 12 16
	12×12 32×25	
	105	96 – 101

SVHB(C)(RL) EXT

107°30'		VB, VC..
		11 16
	16×16 25×25	
	120	113 – 119

SVJB(C)(RL) EXT

93°		VB, VC..
		11 13 16
	12×12 32×25	
	121	113 – 119

SVPB(C)(RL) EXT

117°30'		VB, VC..
		11 16
	16×16 32×25	
	123	113 – 119

SVVB(C)N EXT

72°30'		VB, VC..
		11 13 16
	12×12 32×25	
	124	113 – 119

SVXB(C)(RL) EXT

98°		VB, VC..
		11 13 16
	12×12 32×25	
	125	113 – 119

C.-SRDCN EXT

		RC..
		10 12
	C4 C5	
	107	96 – 101

C.-SVHB(RL) EXT

107°30'		VB, VC..
		16
	C4 C6	
	126	113 – 119

C.-SVJB(RL) EXT

93°		VB, VC..
		11 16
	C3 C6	
	127	113 – 119

C.-SVVBN EXT

72°30'		VB, VC..
		16
	C4 C6	
	128	113 – 119

ISO TURNING – EXTERNAL

SHORT AND STABLE COMPONENTS (negative inserts)

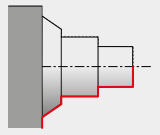

DCBN(RL) EXT 75° 20×20 40×40 147 CN.. 12 16 19 134 – 146		PCBN(RL) EXT 75° 20×20 50×50 151 CN.. 12 16 19 25 134 – 146		DCLN(RL) EXT 95° 16×16 40×40 149 CN.. 09 12 16 19 134 – 146		PCLN(RL) EXT 95° 20×20 50×50 153 CN.. 12 16 19 25 134 – 146	
DDJN(RL) EXT 93° 20×20 32×32 178 DN.. 11 15 170 – 177		PDJN(RL) EXT 93° 20×20 32×32 179 DN.. 11 15 170 – 177		PDNN(RL) EXT 62°30' 20×20 32×25 180 DN.. 11 15 170 – 177		PSBN(RL) EXT 75° 20×20 50×50 206 SN.. 12 15 19 25 197 – 205	
DVJN(RL) EXT 93° 20×20 32×25 226 VN.. 16 223		MVJN(RL) EXT 93° 20×20 32×25 228 VN.. 16 223		DVPN(RL) EXT 62°30' 20×20 32×25 227 VN.. 16 223		DWLN(RL) EXT 95° 16×16 40×40 239 WN.. 06 08 10 13 231 – 238	
MWLN(RL) EXT 95° 25×25 40×40 241 WN.. 08 231 – 238		PWLN(RL) EXT 95° 16×16 32×25 242 WN.. 06 08 231 – 238					

ISO TURNING – EXTERNAL

SHORT AND STABLE COMPONENTS (negative inserts)

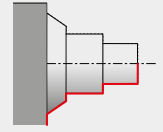

C.-DCLN(RL) EXT	
95°	CN..
	 12 16 19
	$\frac{C3}{C8}$
	 155 134 – 146

C.-DDJN(RL) EXT	
93°	DN..
	 11 15
	$\frac{C4}{C6}$
	 181 170 – 177

C.-DDNNN EXT	
62.5°	DN..
	 15
	$\frac{C5}{C6}$
	 182 170 – 177

C.-DVJN(RL) EXT	
93°	VN..
	 16
	$\frac{C4}{C6}$
	 229 223

C.-DWLN(RL) EXT	
95°	WN..
	 06 08
	$\frac{C4}{C6}$
	 243 231 – 238

ISO TURNING - HEAVY ROUGHING - EXTERNAL
FIXED TOOL HOLDERS

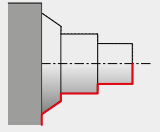

DCBN(RL) EXT	
75°	CN..
	19
	40×40
	147
	134 – 146

PCBN(RL) EXT	
75°	CN..
	19 25
	40×40 50×50
	151
	134 – 146

DCLN(RL) EXT	
95°	CN..
	19
	40×40
	149
	134 – 146

PCLN(RL) EXT	
95°	CN..
	19 25
	40×40 50×50
	153
	134 – 146

PRDCN EXT	
	RC..
	16 20 25 32
	32×25 50×50
	102
	96 – 101

PRSC(RL) EXT	
	RC..
	16 20 25
	32×25 40×40
	103
	96 – 101

PSBN(RL) EXT	
75°	SN..
	19 25
	40×40 50×50
	206
	197 – 205

DWLN(RL) EXT	
95°	WN..
	13
	40×40
	239
	231 – 238

ISO TURNING – HEAVY ROUGHING – EXTERNAL HEAD (KH)

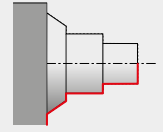

KHP-CBNR + DKH(RL)

75°

CN..

25

DKHR+KHP-CBNR

	40×50 60×80
--	----------------

157 134 – 146

KHP-CBNL + DKH(RL)

75°

CN..

25

DKHR+KHP-CBNL

	40×50 60×80
--	----------------

157 134 – 146

KHP-CLNR/L + DKH(RL)

95°

CN..

19
25

DKHR+KHP-CLNR

	40×50 60×80
--	----------------

158 134 – 146

KHP-RSCR/L + DKH(RL)

RC..

20
25
32

DKHR+KHP-RSCR

	40×50 60×80
--	----------------

108 118 – 123

KHP-SBNR + DKH(RL)

75°

SN..

25

DKHR+KHP-SBNR

	40×50 60×80
--	----------------

208 197 – 205

KHP-SBNL + DKH(RL)

75°

SN..

25

DKHR+KHP-SBNL

	40×50 60×80
--	----------------

208 197 – 205

KHP-SSNR/L + DKH(RL)

45°

SN..

19
25

DKHR+KHP-SSNR

	40×50 60×80
--	----------------

209 197 – 205



ISO TURNING – HEAVY ROUGHING – EXTERNAL
RAILWAY WHEEL MACHINING

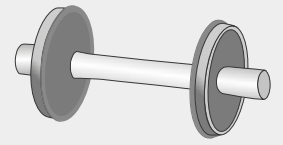

DKT(RL)-A1 + KTP		CN..	LN..	SN..
		19	19 30	19
	50x55	KTP-CAN(RL)	KTP-LAN(RL)	KTP-SAN(RL)
	160, 186, 211			
		134 – 146, 167	184 – 185, 193	197 – 205, 218

DKT(RL)-A2 + KTP		CN..	LN..	SN..
		19	19 30	19
	50x55	KTP-CAN(RL) KTP-CFN(RL)	KTP-LAN(RL) KTP-LFN(RL)	KTP-SAN(RL) KTP-SFN(RL)
	160, 186, 211			
		134 – 146, 167 – 168	184 – 185, 193 – 194	197 – 205, 218 – 219

DKT(RL)-B1 + KTP		CN..	LN..	SN..
		19	19 30	19
	50x49.5	KTP-CAN(RL)	KTP-LAN(RL)	KTP-SAN(RL)
	161, 187, 212			
		134 – 146, 167 – 168	184 – 185, 193	197 – 205, 218

DKT(RL)-B2 + KTP		CN..	LN..	SN..
		19	19 30	19
	50x49.5	KTP-CAN(RL) KTP-CFN(RL)	KTP-LAN(RL) KTP-LFN(RL)	KTP-SAN(RL) KTP-SFN(RL)
	161, 187, 212			
		134 – 146, 167 – 168	184 – 185, 193 – 194	197 – 205, 218 – 219

DKT(RL)-C1 + KTP		CN..	LN..	SN..
		19	19 30	19
	55x55	KTP-CAN(RL)	KTP-LAN(RL)	KTP-SAN(RL)
	162, 188, 213			
		134 – 146, 167 – 168	184 – 185, 193	197 – 205, 218

DKT(RL)-C2 + KTP		CN..	LN..	SN..
		19	19 30	19
	55x55 55x52	KTP-CAN(RL) KTP-CFN(RL)	KTP-LAN(RL) KTP-LFN(RL) KTP-LAN(RL)30/X	KTP-SAN(RL) KTP-SFN(RL)
	162, 188, 213			
		134 – 146, 167 – 168	184 – 185, 193 – 194	197 – 205, 218 – 219

DKT(RL)-D1 + KTP		CN..	LN..	SN..
		19	19 30	19
	50x49.5	KTP-CAN(RL)	KTP-LAN(RL)	KTP-SAN(RL)
	163, 189, 214			
		134 – 146, 167 – 168	184 – 185, 193 – 194	197 – 205, 218

DKT(RL)-D2 + KTP		CN..	LN..	SN..
		19	19 30	19
	50x49.5	KTP-CAN(RL) KTP-CFN(RL)	KTP-LAN(RL) KTP-LFN(RL)	KTP-SAN(RL) KTP-SFN(RL)
	163, 189, 214			
		134 – 146, 167 – 168	184 – 185, 193 – 194	197 – 205, 218 – 219

S-DKT(RL)4065X-C		CN..
		19
	45x65	
	164	
		134 – 146

S-DKT(RL)4065X-S		SN..
		19
	45x65	
	191, 216	
		197 – 205

S-DKT(RL)4065X + KTP		CN..	LN..	SN..
		19	19 30	19
	45x65	KTP-CAN(RL) KTP-CFN(RL)	KTP-LAN(RL) KTP-LFN(RL)	KTP-SAN(RL) KTP-SFN(RL)
	165			
		134 – 146, 167 – 168	184 – 185, 193 – 194	197 – 205, 218 – 219

S-DKT(RL)5556 + KTP		CN..	LN..	SN..
		19	19 30	19
	56x55	KTP-CAN(RL) KTP-CFN(RL)	KTP-LAN(RL) KTP-LFN(RL)	KTP-SAN(RL) KTP-SFN(RL)
	166, 192, 217			
		134 – 146, 167 – 168	184 – 185, 193 – 194	197 – 205, 218 – 219

INSERTS – ISO CODE DESIGNATION

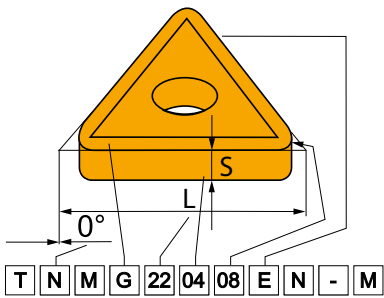

ISO

ANSI

1	2	3	4
T	N	U	N
T	N	M	G
1	2	3	4
T	N	U	
T	N	M	G

1				1			
Insert shape							
H	O	P	R				
S	T	C	D				
E	M	V	W				
L	A	B	K				

2		2	
Insert clearance angle			
A		B	
C		D	
E		F	
G		N	
P		O	Special

4		4	
Insert type			
N			
R			
F			
A			
M			
G			
W			
T			
Q			
U			
B			
H			
C			
J			
X	Special		

3 **3**

Tolerances

	(mm)			(")		
	M (±)	S (±)	IC (±)	M (±)	S (±)	IC (±)
A	0.005	0.025	0.025	.0002"	.001"	.0010"
F	0.005	0.025	0.013	.0002"	.001"	.0005"
C	0.013	0.025	0.025	.0005"	.001"	.0010"
H	0.013	0.025	0.013	.0005"	.001"	.0005"
E	0.025	0.025	0.025	.0010"	.001"	.0010"
G	0.025	0.130	0.025	.0010"	.005"	.0010"
J	0.005	0.025	0.05 – 0.13	.0002"	.001"	.002 – 0.005"
K	0.013	0.025	0.05 – 0.13	.0005"	.001"	.002 – 0.005"
L	0.025	0.025	0.05 – 0.13	.0010"	.001"	.002 – 0.005"
M	0.08 – 0.18	0.130	0.05 – 0.13	.003 – 0.007"	.005"	.002 – 0.005"
N	0.08 – 0.18	0.025	0.05 – 0.13	.003 – 0.007"	.001"	.002 – 0.005"
U	0.05 – 0.38	0.130	0.05 – 0.13	.005 – 0.015"	.005"	.003 – 0.010"

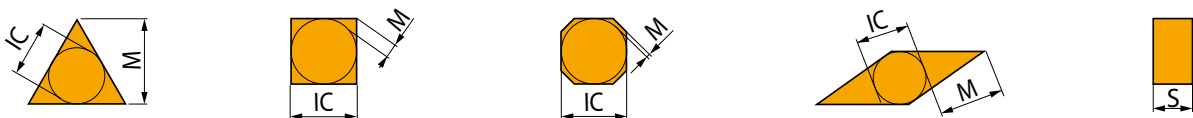



INSERTS – ISO CODE DESIGNATION

5	6	7	8	9	10
22	04	08			
22	04	08	E	N	M
5	6	7	8	9	10
4	3	2			
4	3	2	E	N	M

5		5												
Insert cutting edge length (insert size)														
d = IC		H	O	P	S	T	C	D	E	M	V	W	R	K
(mm)	(in)													
3.97	5/32"				03	06		04			06	02		
4.76	3/16"				04	08	04	05	04	04	08	L3		
5.56	7/32"				05	09	05	06	05	05	09	03		
6.35	1/4"	03	02	04	08	11	06	07	08	08	11	04	06	
7.94	5/16"	04	03	05	07	13	08	09	06	07	13	05	07	
9.525	3/8"	05	04	07	09	16	09	11	09	09	16	06	09	16
12.7	1/2"	07	05	09	12	22	12	15	13	12	22	08	12	
15.875	5/8"	09	06	11	15	27	16	19	16	15	27	10	15	
19.05	3/4"	11	07	13	19	33	19	23	19	19	33	13	19	
25.40	1"	14	10	18	25	44	25	31	26	25	44	17	25	
31.75	1 1/4"	18	13	23	31	54	32	38	32	31	54	21	31	

6		7	
Insert thickness		Insert nose radius	
		(mm)	(")
01	1.59	1/16"	
T1	1.98	5/64"	
02	2.38	3/32"	
03	3.18	1/8"	
T3	3.97	5.32"	
04	4.76	3/16"	
05	5.56	7/32"	
06	6.35	1/4"	
07	7.94	5/16"	
09	9.52	3/8"	

RE	
(mm)	(")
00	0
02	0.2
04	0.4
08	0.8
12	1.2
16	1.6
24	2.4
32	3.2

Round inserts

d = I.C.	
(")	00
(mm)	M0

ANSI		
5	6	7
Inscribed circle	Insert thickness	Insert nose radius
Symbol	Symbol	Symbol
	(mm)	(mm)
	(")	(")
1	1.588	0
1.2	1.984	0.099
1.5	2.381	0.198
1.8	3.175	0.397
2	3.969	0.794
2.5	4.763	1.191
3	5.556	1.588
3.5	6.350	1.984
4	7.938	2.381
5	9.525	2.778
6	11.113	3.175
7	12.700	3.572
8	14.288	3.969
10	15.875	4.366
12		4.763

8		8	
Insert cutting edge design			
	Sharp edges		Rounded edges
	Edges with facet		Rounded edges with facet
	Edges with double facet		Rounded edges with double facet

9		9	
Feed direction			
R		N	
L			

10		10	
Chip breaker designation			



EXTERNAL TURNING TOOLS – ISO CODE DESIGNATION

Shank tool	ISO	2	3	4	5	6	7	8	11	12	13
		P	C	L	N	R	- 32 25	L	12	- M	
PSC	ISO	1	2	3	4	5	6	9	10	12	
		C4	- D	C	L	N	R	- 27 050	- 12		
Shank tool	ANSI	2	3	4	5	6	7 & 8	12	11		
		D	C	L	N	R	- 16	4	D		

1		2		3				4				
Coupling size		Clamping designation		Insert shape				Holder style – cutting edge angle				
	C	C	C	H	O	P	R	A	B	C	D	D
	C3	D	D									
	C4	P	P	S	T	C	D					
	C5	M	M									
	C6	S	S									
	C8	X	X	L	A	B	K				Special	
	G	G										

5		6	
Insert clearance angle		Direction of cut	
AN		R	
N	B	L	
0°	5°	N	
C	P		
7°	11°		

7 & 8	
Shank width & Shank height (")	
Symbol	H (")
05	5/16"
06	3/8"
08	1/2"
10	5/8"
12	3/4"
16	1"
85	1 1/4"
86	1 1/2"
20	1 1/4"
24	1 1/2"
32	2"

11		11	
Holder total length		Holder total length	
	LF (mm)	D	60
		E	70
		F	80
		H	100
		J	110
		K	125
		L	140
	LF (")	M	150
A	4.000"	N	160
B	4.500"	P	170
C	5.000"	Q	180
D	6.000"	R	200
E	7.000"	S	250
F	8.000"	T	300
M	4.000"	U	350
N	4.500"	V	400
R	6.000"	W	450
S	7.000"	X	Spec.
T	8.000"	Y	500

7					
Shank height (mm)					
08	10	12	16	20	25
32	38	40	45	50	60

8					
Shank width (mm)					
08	10	12	16	20	25
32	38	40	45	50	60

9		10	
Functional width (mm)		Functional length (mm)	
WF		LF	

INTERNAL TURNING TOOLS – ISO CODE DESIGNATION

ISO	15	16	17	2	3	4	5	6	12	14
	A	25	T	P	C	L	N	L	12	X
ANSI	15	16	17	2	3	4	5	6	12	
	A	16	T	D	C	L	N	L	4	

12		12											
Insert cutting edge length (insert size)													
d = I.C.	H	O	P	S	T	C	D	E	M	V	W	R	K
(mm)													
3.97				03	06		04			06	02		
5/32"						1.2							
4.76				04	08	04	05	04	04	08	L3		
3/16"						1.5							
5.56				05	09	05	06	05	05	09	03		
7/32"						1.8							
6.35	03	02	04	08	11	06	07	08	08	11	04	06	
1/4"						2							
7.94	04	03	05	07	13	08	09	06	07	13	05	07	
5/16"						2.5							
9.525	05	04	07	09	16	09	11	09	09	16	06	09	16
3/8"						3							
12.7	07	05	09	12	22	12	15	13	12	22	08	12	
1/2"						4							
15.875	09	06	11	15	27	16	19	16	15	27	10	15	
5/8"						5							
19.05	11	07	13	19	33	19	23	19	19	33	13	19	
3/4"						6							
25.40	14	10	18	25	44	25	31	26	25	44	17	25	
1"						8							
31.75	18	13	23	31	54	32	38	32	31	54	21	31	
1 1/4"						10							

13	
Manufacturer's designation	
M	Clamping system "S" with shim

14	
Manufacturer's designation	
X	Special shank style
.	
.	
93	Z – style tool setting angle
.	
.	

15		15	
Shank			
S	Steel shank		
A	Steel shank with coolant hole		
E	Tungsten carbide shank with coolant hole		

16		16	
Shank Ø (mm)			
	DCON MS (mm)		DCON MS (")
08	8	03	.1875"
10	10	04	.250"
12	12	05	.3125"
16	16	06	.375"
20	20	08	.500"
25	25	10	.625"
32	32	12	.750"
40	40	16	1.000"
50	50	20	1.250"
60	60	24	1.500"
		32	2.000"

17		17	
Holder total Length			
			LF (mm)
		D	60
		E	70
		F	80
		H	100
		J	110
		K	125
		L	140
		M	150
		N	160
		P	170
		Q	180
		R	200
		S	250
		T	300
		U	350
		V	400
		W	450
		X	Spec.
		Y	500

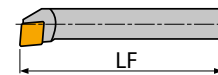



HEADS – ISO CODE DESIGNATION

CARTRIDGE

1	2	–	3	4	5	6	7
KH	P		C	L	N	R	25

HOLDER

8	6	9	10	11
DKH	R	50	60	W

1	2	3	4
Cartridge	Clamping designation	Insert shape	Holder style – cutting edge angle
5 Insert clearance angle	C	S	A
	D	C	B
N 0°	P	T	C
C 7°	M	D	D
P 11°	S	R	D
6 Direction of cut	X	K	E
R	W	V	F
L	L	X Special	G
N	G		H
			J
			K
			L
			M
			N
			P
			Q
			R
			S
			S
			T
			U
			V
			W
			X Special
			Y
			Z

		7 Insert cutting edge length (insert size)												
d = I.C.		H	O	P	S	T	C	D	E	M	V	W	R	K
(mm)	(")													
3.97	5/32"				03	06		04			06	02		
4.76	3/16"				04	08	04	05	04	04	08	L3		
5.56	7/32"				05	09	05	06	05	05	09	03		
6.35	1/4"	03	02	04	08	11	06	07	08	08	11	04	06	
7.94	5/16"	04	03	05	07	13	08	09	06	07	13	05	07	
9.525	3/8"	05	04	07	09	16	09	11	09	09	16	06	09	16
12.7	1/2"	07	05	09	12	22	12	15	13	12	22	08	12	
15.875	5/8"	09	06	11	15	27	16	19	16	15	27	10	15	
19.05	3/4"	11	07	13	19	33	19	23	19	19	33	13	19	
25.40	1"	14	10	18	25	44	25	31	26	25	44	17	25	
31.75	1 1/4"	18	13	23	31	54	32	38	32	31	54	21	31	

8 Cartridge holder

9 Shank height (mm)

08 10 12 16 20 25
32 40 50 60 70 80

10 Shank width (mm)

08 10 12 16 20 25
32 40 50 60 70 80

11 Holder total length

	LF (mm)
H	100
J	110
K	125
L	140
M	150
N	160
P	170
Q	180
R	200
S	250
T	300
U	350
V	400
W	450
X	Spec.
Y	500

ISO CODE DESIGNATION HOLDERS AND CARTRIDGES FOR RAILWAY WHEEL MACHINING

CARTRIDGE

1 **KT** **2** **P** - **3** **L** **4** **A** **5** **N** **6** **L** **7** **19**

HOLDERS

8 **DKT** **6** **R** **9** **50** **10** **55** **11** **X** **12** **X**

1 Cartridge	2 Clamping system P	3 Insert shape C S L	4 Tool style – cutting edge angle A F
5 Clearance angle N $\alpha_n=0^\circ$	6 Direction of cut R L		7 Cutting edge length

8 Cartridge holder	9 Shank height (mm) 50 55
11 Total length X	10 Shank width (mm) 50 55

12 Type of machine					
A1	Hegenscheidt	1 cartridge in the holder	C1	Rafamet UBB 112/2	1 cartridge in the holder
A2	Hegenscheidt	2 cartridges in the holder	C2	Rafamet UBB 112/2	2 cartridges in the holder
B1	Rafamet UDA 125N	1 cartridge in the holder	D1	Rafamet UBB 112	1 cartridge in the holder
B2	Rafamet UDA 125N	2 cartridges in the holder	D2	Rafamet UBB 112	2 cartridges in the holder
4065X-C	Talgo	2 CNMX inserts in the holder	4065X-S	Talgo	2 SNMX inserts in the holder
4065X+KTP	Talgo	2 cartridges in the holder	5556+KTP	Talgo	2 cartridges in the holder

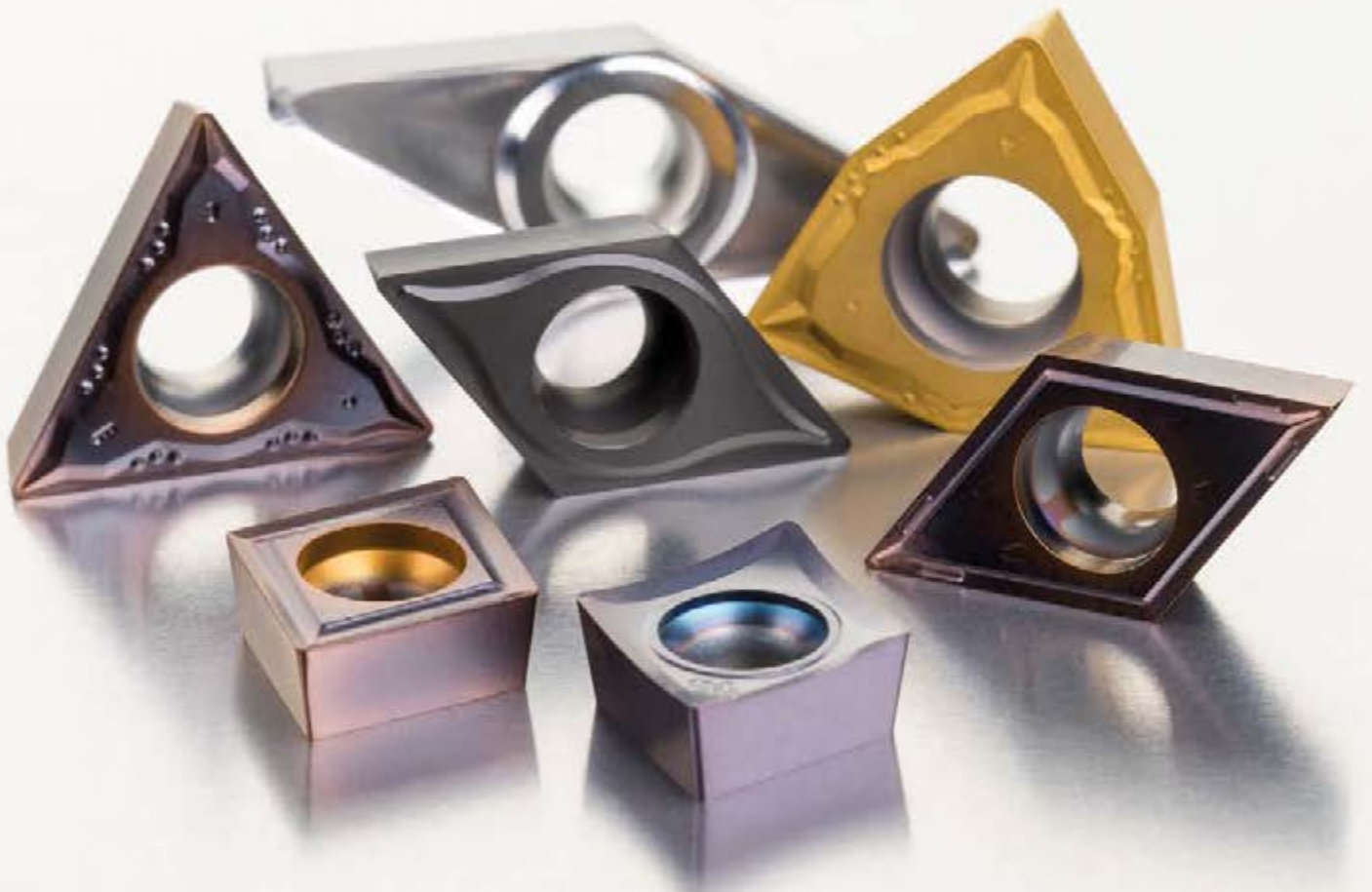

POSITIVE INSERTS



OP

06

CARBIDE INSERTS

OPCN

94



OPCN 06

	IC (mm)	L (mm)	S (mm)
1606	15.875	6.576	3.18

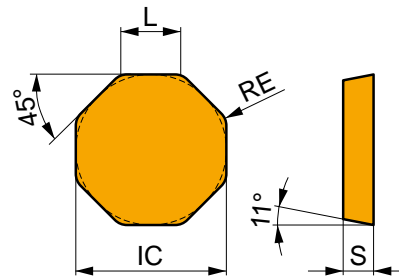

Suitability and starting values for cutting speed (vc), feed (f) and depth of cut (ap). Refer to our Machining Calculator app for further calculations.

Product	RE (mm)	P			M			K			N			S			H		
		vc (m/min)	f (mm/rev)	ap (mm)	vc (m/min)	f (mm/rev)	ap (mm)	vc (m/min)	f (mm/rev)	ap (mm)	vc (m/min)	f (mm/rev)	ap (mm)	vc (m/min)	f (mm/rev)	ap (mm)	vc (m/min)	f (mm/rev)	ap (mm)

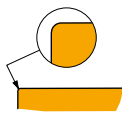

Geometry for finish to medium machining, continuous to interrupted cuts.

OPCN 06-2081000*	T9315	1.7	95	0.60	2.0	65	0.60	2.0	90	0.60	2.0	-	-	-	-	-	-	-
S-OPCN06-000720*	T8330	1.3	105	0.60	1.5	70	0.60	1.5	100	0.60	1.5	-	-	-	-	-	-	-
S-OPCN06-001355*	T8330	1.3	105	0.60	2.0	70	0.60	2.0	100	0.60	2.0	-	-	-	-	-	-	-
	T9315	1.3	95	0.60	2.0	65	0.60	2.0	90	0.60	2.0	-	-	-	-	-	-	-

* Special items



RC

06/ 08/ 10/ 12/ 16/ 20/ 25/ 30/ 32

CARBIDE INSERTS

RCMH



96

RCMT



97

RCMX



99

RCUM



101

MATCH THE RIGHT SIZE (example)

Insert

RCMT 1204MOE-RM3

Tool Holder

SRDCN 3225 P 12-M

PRDCN EXT

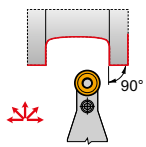

32×25
50×50

102

RC..



16
20
25
32

96 – 101

PRSC(RL) EXT

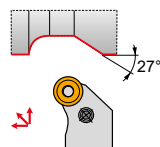

32×25
40×40

103

RC..



16
20
25

96 – 101

SRDCN EXT

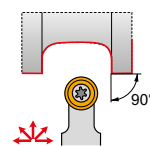

12×12
32×25

104

RC..



06
08
10
12
16

96 – 101

SRSC(RL) EXT

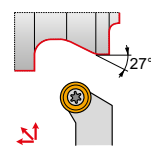

12×12
32×25

105

RC..



06
08
10
12
16

96 – 101

C.-SRDCN EXT

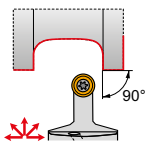

C4
C5

107

RC..



10
12

96 – 101

KHP-RSCR/L + DKH(RL)

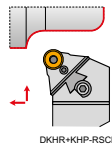

40×50
60×80

108

RC..



20
25
32

96 – 101



RCMH



	INSD	D1	S
	(mm)	(mm)	(mm)
3209	32.000	10.50	9.53
000403	32.000	10.50	9.53
001450	32.000	10.50	9.53

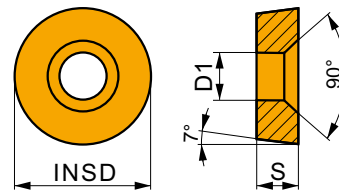

Suitability and starting values for cutting speed (vc), feed (f) and depth of cut (ap). Refer to our Machining Calculator app for further calculations.

Product	RE	P			M			K			N			S			H		
		vc	f	ap	vc	f	ap	vc	f	ap	vc	f	ap	vc	f	ap	vc	f	ap
	(mm)	(m/min)	(mm/rev)	(mm)	(m/min)	(mm/rev)	(mm)	(m/min)	(mm/rev)	(mm)	(m/min)	(mm/rev)	(mm)	(m/min)	(mm/rev)	(mm)	(m/min)	(mm/rev)	(mm)

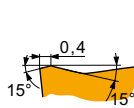

RM2 geometry for semi-rough to rough machining, and continuous to interrupted cuts.

RCMH 3209MO-RM2*	T5315	–	95	1.00	4.5	–	–	–	90	1.00	4.5	–	–	–	–	–	–	–	–	–
S-RCMH3209MO-RM2*	T5305	–	95	1.00	4.5	–	–	–	95	1.00	4.5	–	–	–	–	–	–	–	–	–
S-RCMH3209MO-RM2*	T9210	–	90	1.00	4.5	–	–	–	85	1.00	4.5	–	–	–	–	–	–	–	–	–

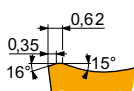

RR2 geometry for heavy rough machining, and continuous to interrupted cuts.

RCMH 3209MO-RR2*	6630	–	70	1.00	4.5	–	–	–	65	1.00	4.5	–	–	–	–	–	–	–	–	–
------------------	------	---	----	------	-----	---	---	---	----	------	-----	---	---	---	---	---	---	---	---	---

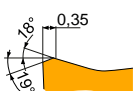

000403 geometry for semi-rough to heavy-rough machining, and continuous to interrupted cuts.

S-RCMH32-000403*	T9315	–	85	1.00	4.5	–	–	–	85	1.00	4.5	–	–	–	–	–	–	–	–	–
	T9325	–	75	1.00	4.5	–	–	–	70	1.00	4.5	–	–	–	–	–	–	–	–	–

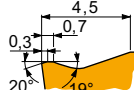

001450 geometry for roughing to heavy-rough machining, and continuous to interrupted cuts.

S-RCMH32-001450*	T9310	–	60	1.40	4.5	–	–	–	55	1.40	4.5	–	–	–	–	–	–	–	–	–
------------------	-------	---	----	------	-----	---	---	---	----	------	-----	---	---	---	---	---	---	---	---	---

* Special items



RCMT



	INSD (mm)	D1 (mm)	S (mm)
0602	6.000	2.80	2.38
0803	8.000	3.40	3.18
10T3	10.000	4.40	3.97
1204	12.000	4.40	4.76
1606	16.000	5.50	6.35
2006	20.000	6.50	6.35
2507	25.000	8.60	7.94
3009	30.000	10.00	9.53

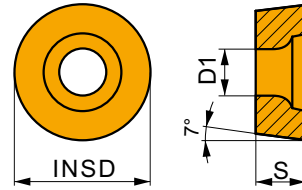

Suitability and starting values for cutting speed (vc), feed (f) and depth of cut (ap). Refer to our Machining Calculator app for further calculations.

Product	RE (mm)	P			M			K			N			S			H		
		vc (m/min)	f (mm/rev)	ap (mm)	vc (m/min)	f (mm/rev)	ap (mm)	vc (m/min)	f (mm/rev)	ap (mm)	vc (m/min)	f (mm/rev)	ap (mm)	vc (m/min)	f (mm/rev)	ap (mm)	vc (m/min)	f (mm/rev)	ap (mm)



Geometry 37 for semi-rough to heavy-rough machining, and continuous to interrupted cuts.

RCMT 1606M05-37	T9315	-	165	0.60	3.0	-	-	-	155	0.60	3.0	-	-	-	-	-	-	-	-
	T9325	-	145	0.60	3.0	-	-	-	135	0.60	3.0	-	-	-	-	-	-	-	-

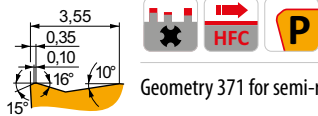

Geometry 371 for semi-rough to heavy-rough machining, and continuous to interrupted cuts.

RCMT 2006M05-371	T9315	-	145	0.80	3.0	-	-	-	135	0.80	3.0	-	-	-	-	-	-	-	-
	T9325	-	125	0.80	3.0	-	-	-	115	0.80	3.0	-	-	-	-	-	-	-	-

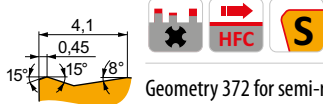

Geometry 372 for semi-rough to heavy-rough machining, continuous to interrupted cuts.

RCMT 2507M05-372	T9325	-	90	0.80	3.0	-	-	-	85	0.80	3.0	-	-	-	-	-	-	-	-
------------------	-------	---	----	------	-----	---	---	---	----	------	-----	---	---	---	---	---	---	---	---



FM geometry for finish to semi-rough machining, and continuous to slightly interrupted cuts.

RCMT 0602M0E-FM	T7325	-	215	0.45	1.2	165	0.41	1.2	-	-	-	-	-	-	-	-	-	-	-
	T8430	-	200	0.45	1.2	110	0.41	1.2	165	0.45	1.2	555	0.54	1.2	-	-	-	-	-
	T9315	-	260	0.45	1.2	-	-	-	245	0.45	1.2	-	-	-	-	-	-	-	-
	T9325	-	235	0.45	1.2	140	0.41	1.2	220	0.45	1.2	-	-	-	-	-	-	-	-
RCMT 0803M0E-FM	T7325	-	190	0.60	1.6	145	0.54	1.6	-	-	-	-	-	-	-	-	-	-	-
	T8430	-	175	0.60	1.6	95	0.54	1.6	140	0.60	1.6	480	0.72	1.6	-	-	-	-	-
	T9315	-	225	0.60	1.6	-	-	-	210	0.60	1.6	-	-	-	-	-	-	-	-
	T9325	-	200	0.60	1.6	120	0.54	1.6	190	0.60	1.6	-	-	-	-	-	-	-	-
RCMT 10T3M0E-FM	T7325	-	185	0.65	1.7	140	0.59	1.7	-	-	-	-	-	-	-	-	-	-	-
	T8430	-	170	0.65	1.7	90	0.59	1.7	135	0.65	1.7	465	0.78	1.7	-	-	-	-	-
	T9315	-	220	0.65	1.7	-	-	-	205	0.65	1.7	-	-	-	-	-	-	-	-
	T9325	-	195	0.65	1.7	115	0.59	1.7	185	0.65	1.7	-	-	-	-	-	-	-	-
RCMT 1204M0E-FM	T7325	-	175	0.70	1.8	135	0.63	1.8	-	-	-	-	-	-	-	-	-	-	-
	T8430	-	155	0.70	1.8	85	0.63	1.8	130	0.70	1.8	435	0.84	1.8	-	-	-	-	-
	T9315	-	205	0.70	1.8	-	-	-	190	0.70	1.8	-	-	-	-	-	-	-	-
	T9325	-	190	0.70	1.8	110	0.63	1.8	180	0.70	1.8	-	-	-	-	-	-	-	-



Suitability and starting values for cutting speed (vc), feed (f) and depth of cut (ap). Refer to our Machining Calculator app for further calculations.

Product	RE (mm)	P			M			K			N			S			H		
		vc (m/min)	f (mm/rev)	ap (mm)	vc (m/min)	f (mm/rev)	ap (mm)	vc (m/min)	f (mm/rev)	ap (mm)	vc (m/min)	f (mm/rev)	ap (mm)	vc (m/min)	f (mm/rev)	ap (mm)	vc (m/min)	f (mm/rev)	ap (mm)

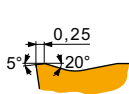

RM3 geometry for semi-rough to rough machining, and continuous to interrupted cuts.

RCMT 0803MOE-RR3	T9315	—	■	225	0.50	1.3	—	—	—	■	210	0.50	1.3	—	—	—	—	—	—	■	45	0.25	0.5	
RCMT 1204MOE-RR3	H07	—	—	—	—	—	■	65	0.54	1.8	■	105	0.60	1.8	—	—	—	—	—	—	—	—	—	
	T7325	—	■	165	0.60	1.8	■	125	0.54	1.8	—	—	—	—	—	—	—	—	—	—	—	—	—	
	T8430	—	■	150	0.60	1.8	■	80	0.54	1.8	■	125	0.60	1.8	—	—	—	—	—	—	■	25	0.30	0.8
	T9315	—	■	205	0.60	1.8	—	—	—	—	■	190	0.60	1.8	—	—	—	—	—	—	■	40	0.30	0.8
RCMT 1606MOE-RR3	T7325	—	■	160	0.65	2.0	■	120	0.59	2.0	—	—	—	—	—	—	—	—	—	—	—	—	—	
	T8430	—	■	145	0.65	2.0	■	80	0.59	2.0	■	120	0.65	2.0	—	—	—	—	—	—	■	25	0.33	1.1
	T9315	—	■	195	0.65	2.0	—	—	—	—	■	185	0.65	2.0	—	—	—	—	—	—	■	35	0.33	1.1

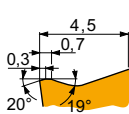

RR4 geometry for heavy rough machining, and continuous to heavy interrupted cuts.

RCMT 3009MO-RR4	T9310	—	■	90	1.10	4.0	—	—	—	■	85	1.10	4.0	—	—	—	—	—	—	—	—	—	—
	T9315	—	■	85	1.10	4.0	—	—	—	■	80	1.10	4.0	—	—	—	—	—	—	—	—	—	—

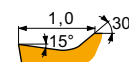

UR geometry for fine to finish machining, and continuous to slightly interrupted cuts.

RCMT 0602MOE-UR	T6310	—	■	170	0.40	1.2	■	120	0.36	1.2	■	135	0.40	1.2	—	—	—	—	—	—	—	—	—
	T8430	—	■	180	0.40	1.2	■	95	0.36	1.2	■	145	0.40	1.2	—	—	—	—	—	—	—	—	—
	T9315	—	■	240	0.40	1.2	—	—	—	—	■	225	0.40	1.2	—	—	—	—	—	—	—	—	—
	T9325	—	■	215	0.40	1.2	■	125	0.36	1.2	■	200	0.40	1.2	—	—	—	—	—	—	—	—	—
RCMT 0803MOE-UR	T6310	—	■	160	0.45	1.6	■	115	0.41	1.6	■	125	0.45	1.6	—	—	—	—	—	—	—	—	—
	T7325	—	■	180	0.45	1.6	■	140	0.41	1.6	—	—	—	—	—	—	—	—	—	—	—	—	—
	T8430	—	■	170	0.45	1.6	■	90	0.41	1.6	■	135	0.45	1.6	—	—	—	—	—	—	—	—	—
	T9315	—	■	220	0.45	1.6	—	—	—	—	■	205	0.45	1.6	—	—	—	—	—	—	—	—	—
	T9325	—	■	200	0.45	1.6	■	120	0.41	1.6	■	190	0.45	1.6	—	—	—	—	—	—	—	—	—
RCMT 10T3MOE-UR	T6310	—	■	160	0.50	1.4	■	115	0.45	1.4	■	125	0.50	1.4	—	—	—	—	—	—	—	—	—
	T7325	—	■	175	0.50	1.4	■	135	0.45	1.4	—	—	—	—	—	—	—	—	—	—	—	—	—
	T8430	—	■	165	0.50	1.4	■	90	0.45	1.4	■	135	0.50	1.4	—	—	—	—	—	—	—	—	—
	T9315	—	■	215	0.50	1.4	—	—	—	—	■	200	0.50	1.4	—	—	—	—	—	—	—	—	—
	T9325	—	■	190	0.50	1.4	■	110	0.45	1.4	■	180	0.50	1.4	—	—	—	—	—	—	—	—	—
RCMT 1204MOE-UR	T6310	—	■	150	0.55	1.8	■	105	0.50	1.8	■	120	0.55	1.8	—	—	—	—	—	—	—	—	—
	T8430	—	■	145	0.55	1.8	■	80	0.50	1.8	■	120	0.55	1.8	—	—	—	—	—	—	—	—	—
	T9315	—	■	200	0.55	1.8	—	—	—	—	■	190	0.55	1.8	—	—	—	—	—	—	—	—	—
	T9325	—	■	180	0.55	1.8	■	105	0.50	1.8	■	170	0.55	1.8	—	—	—	—	—	—	—	—	—









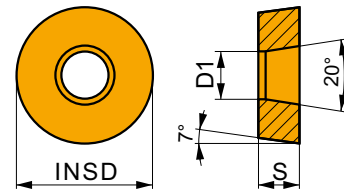











RCMX



	INSD (mm)	D1 (mm)	S (mm)
1003	10.000	3.60	3.18
1204	12.000	4.20	4.76
1606	16.000	5.20	6.35
2006	20.000	6.50	6.35
2507	25.000	7.20	7.94
3209	32.000	9.50	9.53
000108	32.000	9.50	9.53











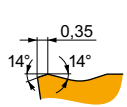



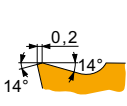



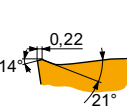



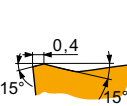

Suitability and starting values for cutting speed (vc), feed (f) and depth of cut (ap). Refer to our Machining Calculator app for further calculations.

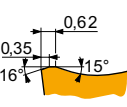
Product	RE (mm)	P			M			K			N			S			H		
		vc (m/min)	f (mm/rev)	ap (mm)	vc (m/min)	f (mm/rev)	ap (mm)	vc (m/min)	f (mm/rev)	ap (mm)	vc (m/min)	f (mm/rev)	ap (mm)	vc (m/min)	f (mm/rev)	ap (mm)	vc (m/min)	f (mm/rev)	ap (mm)
 Geometry 31 for finish to semi-rough machining, and continuous to interrupted cuts.	1.8	14°	7.5°	  	165	0.50	2.0	95	0.45	2.0	155	0.50	2.0	-	-	-	-	-	-
					1003M05-31	T9325	-	-	-	-	-	-	-	-	-	-	-	-	-
 Geometry 37 for semi-rough to heavy-rough machining, and continuous to interrupted cuts.	0.3	5°	 	165	0.60	3.0	-	-	-	155	0.60	3.0	-	-	-	-	-	-	
				1606M05-37	T9315	-	-	-	-	-	-	-	-	-	-	-	-	-	-
RCMX 2006M05-37	6630	-	-	-	-	-	-	-	-	-	-	-	-	-	-	-	-	-	
RCMX 2507M05-37	6630	-	-	-	-	-	-	-	-	-	-	-	-	-	-	-	-	-	
 Geometry 321 for semi-rough to heavy-rough machining, and continuous to interrupted cuts.	2.1	0.2	14°	7.5°	 	130	1.00	3.0	-	-	-	120	1.00	3.0	-	-	-	-	-
						1204M05-321	T9315	-	-	-	-	-	-	-	-	-	-	-	-
	T9325	-	-	-	-	-	-	-	-	-	-	-	-	-	-	-	-	-	
 Geometry 331 for semi-rough to heavy-rough machining, and continuous to interrupted cuts.	2.7	0.2	14°	7.5°	 	100	1.20	3.5	-	-	-	95	1.20	3.5	-	-	-	-	-
						1606M05-331	6630	-	-	-	-	-	-	-	-	-	-	-	-
	T9315	-	-	-	-	-	-	-	-	-	-	-	-	-	-	-	-	-	
	T9325	-	-	-	-	-	-	-	-	-	-	-	-	-	-	-	-	-	
	T9335	-	-	-	-	-	-	-	-	-	-	-	-	-	-	-	-	-	
 Geometry 341 for semi-rough to heavy-rough machining, and continuous to interrupted cuts.	3.0	0.2	14°	7.5°	 	105	1.00	3.5	-	-	-	95	1.00	3.5	-	-	-	-	-
						2006M05-341	6630	-	-	-	-	-	-	-	-	-	-	-	-
	6640	-	-	-	-	-	-	-	-	-	-	-	-	-	-	-	-	-	
 Geometry 351 for semi-rough to heavy-rough machining, and continuous to interrupted cuts.	0.2	14°	14°	 	70	1.00	3.5	-	-	-	65	1.00	3.5	-	-	-	-	-	
					2507M05-351	6630	-	-	-	-	-	-	-	-	-	-	-	-	-
	6640	-	-	-	-	-	-	-	-	-	-	-	-	-	-	-	-	-	



Suitability and starting values for cutting speed (vc), feed (f) and depth of cut (ap). Refer to our Machining Calculator app for further calculations.

Product	RE (mm)	P			M			K			N			S			H			
		vc (m/min)	f (mm/rev)	ap (mm)	vc (m/min)	f (mm/rev)	ap (mm)	vc (m/min)	f (mm/rev)	ap (mm)	vc (m/min)	f (mm/rev)	ap (mm)	vc (m/min)	f (mm/rev)	ap (mm)	vc (m/min)	f (mm/rev)	ap (mm)	
	6640										Geometry 361 for rough to heavy-rough machining and continuous to heavy interrupted cuts.									
		50	1.40	4.5	-	-	-	45	1.40	4.5	-	-	-	-	-	-	-	-	-	
	T5305										RF1 geometry for finish to semi-rough machining, and continuous to interrupted cuts.									
		T9310	105	0.80	3.5	-	-	-	95	0.80	3.5	-	-	-	-	-	-	-	-	
		T9315	100	0.80	3.5	-	-	-	95	0.80	3.5	-	-	-	-	-	-	-	-	
		T9325	90	0.80	3.5	-	-	-	85	0.80	3.5	-	-	-	-	-	-	-	-	
		T9335	110	0.80	3.5	-	-	-	-	-	-	-	-	-	-	-	-	-	-	
		T8345	45	1.00	3.5	-	-	-	40	1.00	3.5	-	-	-	-	-	-	-	-	
	T9310										RM1 geometry for finish to rough machining, and continuous to interrupted cuts.									
		T9315	95	1.00	3.5	-	-	-	90	1.00	3.5	-	-	-	-	-	-	-	-	
		T9325	90	1.00	3.5	-	-	-	85	1.00	3.5	-	-	-	-	-	-	-	-	
		T9335	125	0.60	3.0	-	-	-	-	-	-	-	-	-	-	-	-	-	-	
		T9310	95	1.00	3.5	-	-	-	90	1.00	3.5	-	-	-	-	-	-	-	-	
		T9315	90	1.00	3.5	-	-	-	85	1.00	3.5	-	-	-	-	-	-	-	-	
	T9310										RM2 geometry for semi-rough to rough machining, and continuous to interrupted cuts.									
		T9315	90	1.10	3.5	-	-	-	85	1.10	3.5	-	-	-	-	-	-	-	-	
		T9325	85	1.10	3.5	-	-	-	80	1.10	3.5	-	-	-	-	-	-	-	-	
		T9310	75	1.10	3.5	-	-	-	70	1.10	3.5	-	-	-	-	-	-	-	-	
		T9315	95	1.00	4.5	-	-	-	90	1.00	4.5	-	-	-	-	-	-	-	-	
		T9325	85	1.00	4.5	-	-	-	80	1.00	4.5	-	-	-	-	-	-	-	-	
	T9315										RR2 geometry for heavy rough machining, and continuous to interrupted cuts.									
		T9316	60	1.40	4.5	-	-	-	55	1.40	4.5	-	-	-	-	-	-	10	0.70	2.0
		T9316	60	1.40	4.5	-	-	-	55	1.40	4.5	-	-	-	-	-	-	-	-	
		T9315	95	1.00	4.5	-	-	-	90	1.00	4.5	-	-	-	-	-	-	-	-	
		T9315	85	1.00	4.5	-	-	-	80	1.00	4.5	-	-	-	-	-	-	-	-	
		T9325	75	1.00	4.5	-	-	-	70	1.00	4.5	-	-	-	-	-	-	-	-	
	T9415										000108 geometry for semi-rough to heavy-rough machining, and continuous to interrupted cuts.									
		T9310	90	1.00	4.5	-	-	-	85	1.00	4.5	-	-	-	-	-	-	-	-	
		T9315	85	1.00	4.5	-	-	-	80	1.00	4.5	-	-	-	-	-	-	-	-	
		T9325	75	1.00	4.5	-	-	-	70	1.00	4.5	-	-	-	-	-	-	-	-	



RCUM



	INSD	D1	S
	(mm)	(mm)	(mm)
3010	30.000	10.00	9.60

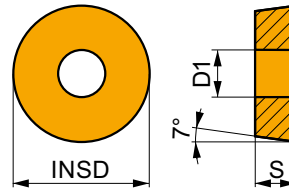

Suitability and starting values for cutting speed (vc), feed (f) and depth of cut (ap). Refer to our Machining Calculator app for further calculations.

Product	RE (mm)	P			M			K			N			S			H		
		vc (m/min)	f (mm/rev)	ap (mm)	vc (m/min)	f (mm/rev)	ap (mm)	vc (m/min)	f (mm/rev)	ap (mm)	vc (m/min)	f (mm/rev)	ap (mm)	vc (m/min)	f (mm/rev)	ap (mm)	vc (m/min)	f (mm/rev)	ap (mm)

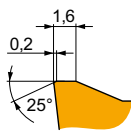

RR7 geometry for heavy-rough machining, and continuous to interrupted cuts.

RCUM 3010M0-RR7*	9215	-	■	70	1.00	4.0	■	-	-	-	▣	65	1.00	4.0	■	-	-	-	■	-	-	-
	S30	-	■	40	0.85	4.0	■	-	-	-	■	-	-	-	■	-	-	-	■	-	-	-

* Special items



PRDCN EXT



PRAMET

P



External Lever Lock Tool Holder for Round RC.. Insert

External neutral lever lock tool holder for positive RC.. 16 up to 32 inserts. Suited for external face and longitudinal turning without shoulder, copy turning up to 90°, taper and chamfer turning. Available with shank size 32x25 up to 50x50 mm. Body treated for longer tool life.

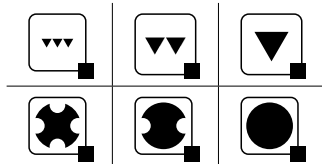
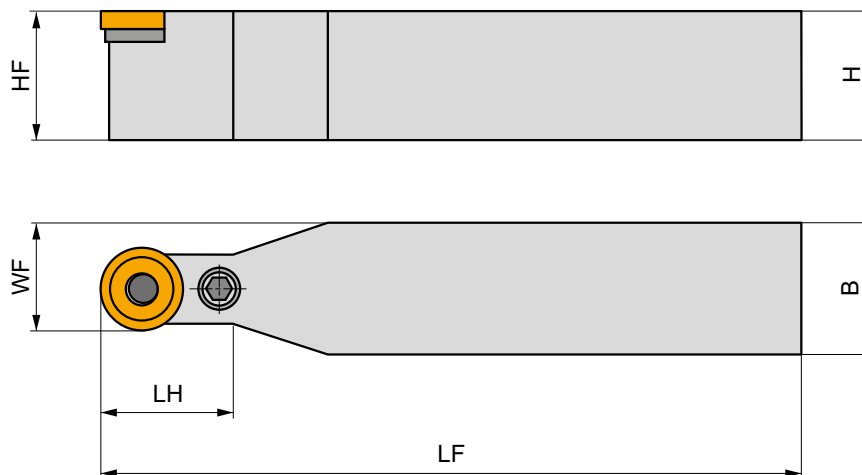
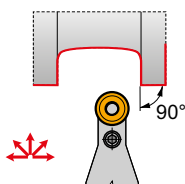

Product	H	B	HF	WF	LF	LH	LAMS	GAMO	kg		
	(mm)	(mm)	(mm)	(mm)	(mm)	(mm)	(°)	(°)			
PRDCN 3225 P 16	32	25	32	20.5	170	32	0	0	0.80	GI090	PRP70
PRDCN 3232 P 20	32	32	32	26	170	32	0	0	1.30	GI069	PRP90
PRDCN 4040 S 20	40	40	40	30	250	40	0	0	3.10	GI069	PRP90
PRDCN 4040 S 25	40	40	40	32.5	250	40	0	0	3.20	GI122	PRP80
PRDCN 5050 S 32	50	50	50	41	250	50	0	0	3.50	GI096	PRP32
PRDCN 5050 T 32	50	50	50	41	300	50	0	0	5.12	GI096	PRP32

GI069				RCMX 2006MO
GI090				RCMX 1606MO
GI096				RCMX 3209MO
GI122				RCMX 2507MO

PRP32	RCU 320600	PU 10	US 47	8.0	M 12x1	36	NT 08	MT 08	HXK 5
PRP70	RCU 160300	PU 07	US 36	6.0	M 8x1	26	NT 05	MT 05	HXK 4
PRP80	RCU 250600	PU 08	US 38	8.0	M 10x1	29	NT 06	MT 06	HXK 5
PRP90	RCU 200400	PU 09	US 36	6.0	M 8x1	26	NT 07	MT 07	HXK 4



PRSC(RL) EXT

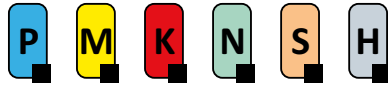

External Lever Lock Tool Holder for Round RC.. Insert

External Right/Left hand lever lock tool holder for positive RC.. 16 up to 25 inserts. Suited for external face and longitudinal turning without shoulder, copy turning up to 27°, taper and chamfer turning, including face copy turning. Available with shank size 32x25 up to 40x40 mm. Body treated for longer tool life.

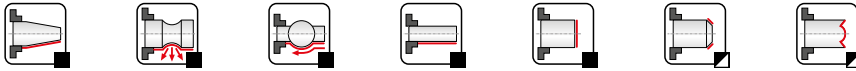
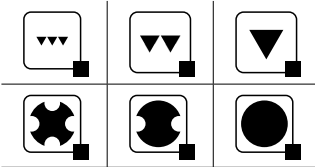
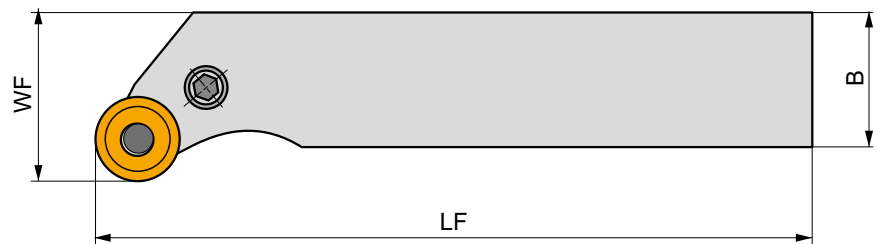
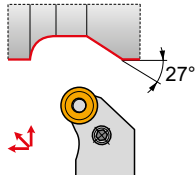

Product	H (mm)	B (mm)	HF (mm)	WF (mm)	LF (mm)	LAMS (°)	GAMO (°)	kg	GI	PRP
R PRSCR 3225 P 16	32	25	32	32	170	0	0	0.90	GI090	PRP70
PRSCR 4040 R 16	40	40	40	50	200	0	0	2.38	GI090	PRP70
PRSCR 3232 P 20	32	32	32	40	170	0	0	1.40	GI069	PRP90
PRSCR 4040 S 25	40	40	40	50	250	0	0	3.40	GI122	PRP80
L PRSCL 3225 P 16	32	25	32	32	170	0	0	0.90	GI090	PRP70
PRSCL 4040 R 16	40	40	40	50	200	0	0	2.38	GI090	PRP70
PRSCL 3232 P 20	32	32	32	40	170	0	0	1.32	GI069	PRP90
PRSCL 4040 S 25	40	40	40	50	250	0	0	3.40	GI122	PRP80



GI069
GI090
GI122

RCMX 2006MO
RCMX 1606MO
RCMX 2507MO



PRP70
PRP80
PRP90

RCU 160300
RCU 250600
RCU 200400

PU 07
PU 08
PU 09

US 36
US 38
US 36

6.0
8.0
6.0

M 8x1
M 10x1
M 8x1

26
29
26

NT 05
NT 06
NT 07

MT 05
MT 06
MT 07

HXK 4
HXK 5
HXK 4



SRDCN EXT

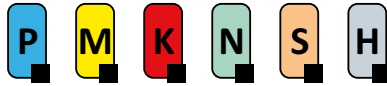

External Screw Lock Tool Holder for Round RC.. Insert

External neutral tool holder for screw type positive RC.. 06 up to 16 inserts. Suited for external face and longitudinal turning without shoulder, copy, taper and chamfer turning. Available with shank size 12x12 up to 32x25 mm. Body treated for longer tool life.

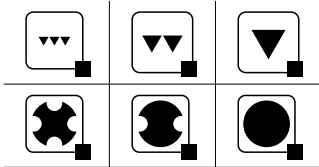
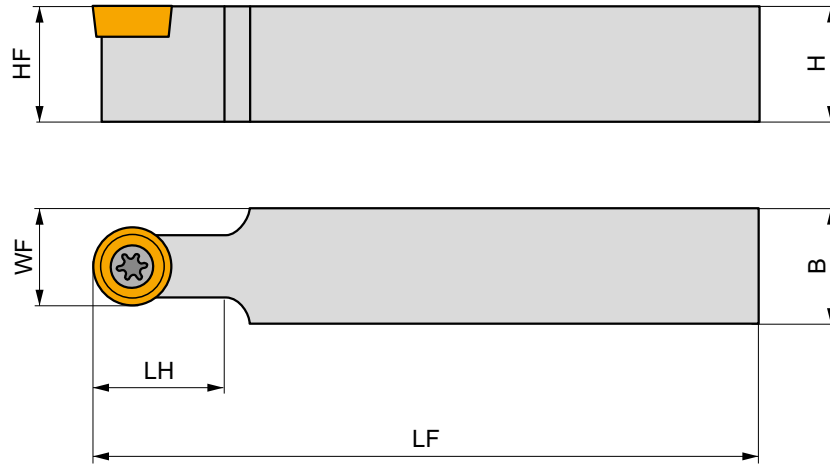
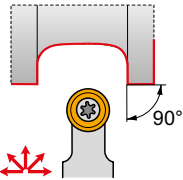

Product	H	B	HF	WF	LF	LH	LAMS	GAMO	kg		
	(mm)	(mm)	(mm)	(mm)	(mm)	(mm)	(°)	(°)			
SRDCN 1212 F 06	12	12	12	9	80	12	0	0	0.10	G1054	S01
SRDCN 1616 H 06	16	16	16	11	100	12	0	0	0.20	G1054	S01
SRDCN 2020 K 08	20	20	20	14	125	20	0	0	0.38	G1051	S03
SRDCN 2020 K 1003-M-A	20	20	20	15	125	25	0	0	0.40	G1064	SR10
N SRDCN 2020 K 10-M-A	20	20	20	15	125	25	0	0	0.40	G1013	SR10
SRDCN 2525 M 10-M-A	25	25	25	17.5	150	25	0	0	0.68	G1013	SR10
SRDCN 2525 M 12-M-A	25	25	25	18.5	150	30	0	0	0.68	G1014	SR12
SRDCN 3225 P 10-M	32	25	32	17.5	170	25	0	0	0.90	G1013	SR10
SRDCN 3225 P 12-M	32	25	32	18.5	170	30	0	0	0.90	G1014	SR12
SRDCN 3225 P 16-M	32	25	32	20.5	170	32	0	0	1.00	G1161	SR16



G1013	RC.. 10T3MO
G1014	RC.. 1204MO
G1051	RC.. 0803MO
G1054	RC.. 0602MO
G1064	RC.. 1003MO
G1161	RC.. 1606MO



S01	US 2506-T07P	0.9	M 2.5	6.3	–	–	FLAG T07P	–
S03	US 3007-T09P	2.0	M 3	7.3	–	–	FLAG T09P	–
SR10	US 3510-T15P	3.0	M 3.5	10.6	SRN 100300	MS 3510	FLAG T15P	HXK 3.5
SR12	US 3510-T15P	3.0	M 3.5	10.6	SRN 120300	MS 3510	FLAG T15P	HXK 3.5
SR16	US 5018-T20P	5.0	M 5	18.2	SRN 16T3MO	MS 5015	FLAG T20P	HXK 5



SRSC(RL) EXT

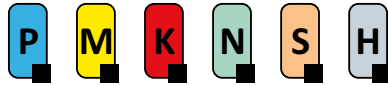

PRAMET

S

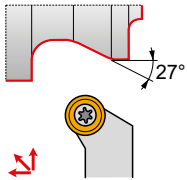

External Screw Lock Tool Holder for Round RC.. Insert

External Right/Left hand tool holder for screw type positive RC.. 06 up to 16 inserts. Suited for external face and longitudinal turning without shoulder, copy, taper and chamfer turning. Available with shank size 12x12 up to 32x25 mm. Body treated for longer tool life.

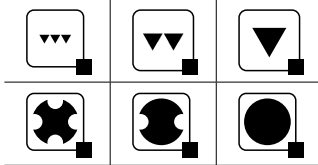
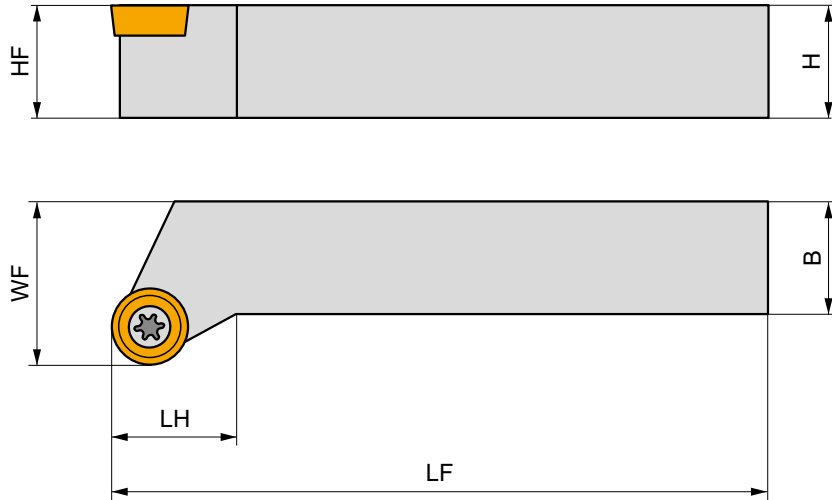

Product	H (mm)	B (mm)	HF (mm)	WF (mm)	LF (mm)	LH (mm)	LAMS (°)	GAMO (°)	kg	GI	SR
R SRSCR 1212 F 06	12	12	12	16	80	12	0	0	0.09	GI054	SO1
SRSCR 1616 H 06	16	16	16	20	100	12	0	0	0.22	GI054	SO1
SRSCR 2020 K 08	20	20	20	25	125	20	0	0	0.45	GI051	SO3
SRSCR 2020 K 10-M-A	20	20	20	25	125	20	0	0	0.45	GI013	SR10
SRSCR 2525 M 10-M-A	25	25	25	32	150	20	0	0	0.75	GI013	SR10
SRSCR 3225 P 10-M	32	25	32	32	170	20	0	0	1.06	GI013	SR10
SRSCR 2525 M 12-M-A	25	25	25	32	150	20	0	0	0.75	GI014	SR12
SRSCR 3225 P 12-M	32	25	32	32	170	20	0	0	1.07	GI014	SR12
SRSCR 3225 P 16-M	32	25	32	32	170	20	0	0	1.10	GI161	SR16
L SRSCL 1212 F 06	12	12	12	16	80	12	0	0	0.10	GI054	SO1
SRSCL 1616 H 06	16	16	16	20	100	12	0	0	0.22	GI054	SO1
SRSCL 2020 K 08	20	20	20	25	125	20	0	0	0.45	GI051	SO3
SRSCL 2020 K 10-M-A	20	20	20	25	125	20	0	0	0.45	GI013	SR10
SRSCL 2525 M 10-M-A	25	25	25	32	150	20	0	0	0.75	GI013	SR10
SRSCL 3225 P 10-M	32	25	32	32	170	20	0	0	1.06	GI013	SR10
SRSCL 2525 M 12-M-A	25	25	25	32	150	20	0	0	0.75	GI014	SR12
SRSCL 3225 P 12-M	32	25	32	32	170	20	0	0	1.07	GI014	SR12
SRSCL 3225 P 16-M	32	25	32	32	170	20	0	0	1.10	GI161	SR16



GI013	RC.. 10T3MO
GI014	RC.. 1204MO
GI051	RC.. 0803MO
GI054	RC.. 0602MO
GI161	RC.. 1606MO

OP









RC

RP

VB

VC



								
S01	US 2506-T07P	0.9	M 2.5	6.3	–	–	FLAG T07P	–
S03	US 3007-T09P	2.0	M 3	7.3	–	–	FLAG T09P	–
SR10	US 3510-T15P	3.0	M 3.5	10.6	SRN 100300	MS 3510	FLAG T15P	HXX 3.5
SR12	US 3510-T15P	3.0	M 3.5	10.6	SRN 120300	MS 3510	FLAG T15P	HXX 3.5
SR16	US 5018-T20P	5.0	M 5	18.2	SRN 16T3M0	MS 5015	FLAG T20P	HXX 5



C.-SRDCN EXT

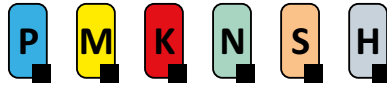

PRAMET

S



External PSC Quick Change Tool, Screw Lock for RC.. Insert

External neutral tool, through coolant, for screw type positive RC.. 10 up to 12 inserts. Suited for external face and longitudinal turning without shoulder, copy, taper and chamfer turning. Available with PSC (Polygon Shank Coupling) size C4 and C5. Body treated for longer tool life.

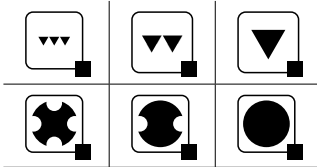
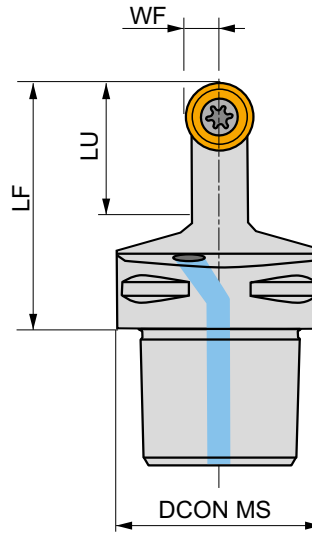
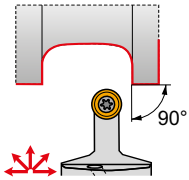

Product	DCON MS (mm)	WF (mm)	LF (mm)	LU (mm)	LAMS (°)	GAMO (°)				
N C4-SRDCN-00050-12A	40	6	50	28	0	0	✓	0.32	GI014	C-SR12V-1
C5-SRDCN-00060-10A	50	5	60	25	0	0	✓	0.56	GI013	C-SR10V
C5-SRDCN-00060-12A	50	6	60	28	0	0	✓	0.56	GI014	C-SR12V-2

GI013	RC.. 10T3MO
GI014	RC.. 1204MO

C-SR10V	US 2010-T15P	3.0	M 3.5	10.1	SRS 110-01	MS 9001	FLAG T15P/3,5	CN 034-02
C-SR12V-1	US 2001-T15P	3.0	M 3.5	12.1	SRS 110-02	MS 9001	FLAG T15P/3,5	CN 034-01
C-SR12V-2	US 2001-T15P	3.0	M 3.5	12.1	SRS 110-02	MS 9001	FLAG T15P/3,5	CN 034-02



KHP-RSC(RL)



PRAMET

P



Modular KHP Lever Lock Turning Cartridge for RC.. Insert

Dovetailed Right/Left hand lever lock turning cartridge for mounting on DKH tool holder shank. Suited for heavy longitudinal turning without shoulder, face turning, taper and chamfer turning with positive RC.. 20 up to 32 inserts. Tool holder treated for longer tool life.

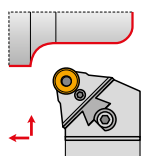

DKHR+KHP-RSCR

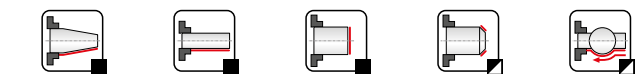
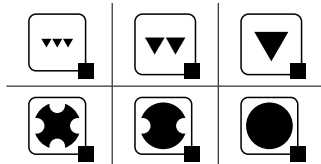
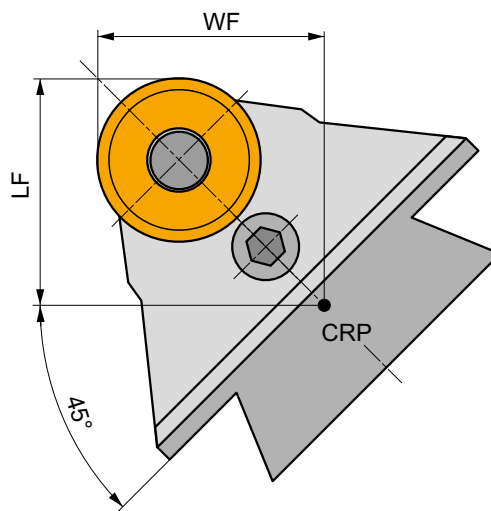

Product	WF	LF	LAMS	GAMO	kg		
	(mm)	(mm)	(°)	(°)			
R KHP-RSCR 20	35	45	0	0	1.30	GI069	PRP90
KHP-RSCR 25	35	45	0	0	1.30	GI122	PRP80
KHP-RSCR 32	35	45	0	0	1.30	GI096	PRP32
L KHP-RSCL 20	35	45	0	0	1.30	GI069	PRP90
KHP-RSCL 25	35	45	0	0	1.30	GI122	PRP80
KHP-RSCL 32	35	45	0	0	1.30	GI096	PRP32

GI069	RCMX 2006MO
GI096	RCMX 3209MO
GI122	RCMX 2507MO

PRP32	RCU 320600	PU 10	US 47	Nm	M 12x1	36	NT 08	MT 08	HXK 5
PRP80	RCU 250600	PU 08	US 38	8.0	M 10x1	29	NT 06	MT 06	HXK 5
PRP90	RCU 200400	PU 09	US 36	6.0	M 8x1	26	NT 07	MT 07	HXK 4



DKH(RL)



External Tool Holder Shank for KHP/KHS Heavy Turning Cartridges

Dovetailed Right/Left hand modular tool shank for KHP/KHS cartridges. Suited for heavy turning applications. Available with shank size 40x50 up to 60x80 mm. Body treated for longer tool life.

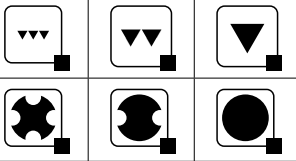
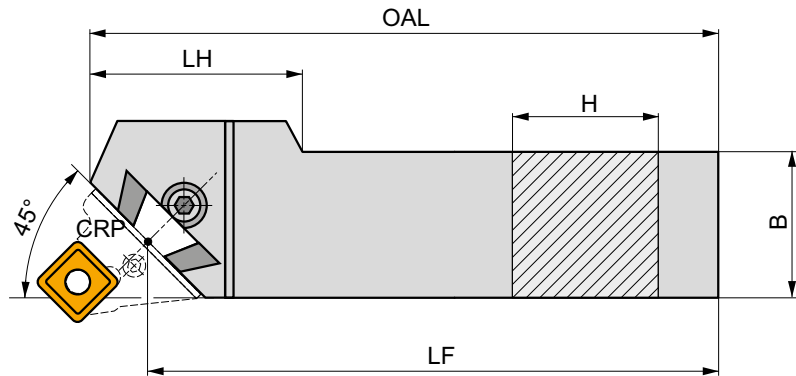
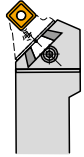

Product	H	B	LF	OAL	LH	kg		
	(mm)	(mm)	(mm)	(mm)	(mm)			
R DKHR 4050 V	40	50	400	425	100	7.10	GI098	DKH10
DKHR 5060 W	50	60	450	475	110	11.30	GI098	DKH10
DKHR 6080 W-A	60	80	450	485	90	19.65	GI098	DKH10
L DKHL 4050 V	40	50	400	425	100	7.10	GI098	DKH10
DKHL 5060 W	50	60	450	475	110	11.30	GI098	DKH10
DKHL 6080 W-A	60	80	450	485	90	19.65	GI098	DKH10



GI098



KHP



KHS



DKH10



SR 14



HXK 10



RP

27/ 30

CARBIDE INSERTS

RPUX



 111





RPUX

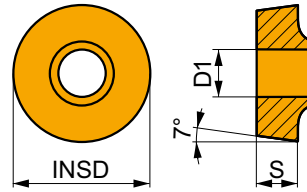

	INSD (mm)	D1 (mm)	S (mm)
2710	27.760	10.20	9.525
3010	30.800	10.00	9.525
1867000	30.800	10.00	9.525



Suitability and starting values for cutting speed (vc), feed (f) and depth of cut (ap). Refer to our Machining Calculator app for further calculations.

Product	RE (mm)	P			M			K			N			S			H		
		vc (m/min)	f (mm/rev)	ap (mm)	vc (m/min)	f (mm/rev)	ap (mm)	vc (m/min)	f (mm/rev)	ap (mm)	vc (m/min)	f (mm/rev)	ap (mm)	vc (m/min)	f (mm/rev)	ap (mm)	vc (m/min)	f (mm/rev)	ap (mm)
 Geometry for heavy-rough machining, and continuous to interrupted cuts.																			
RPUX 2710MO*	T9325	-	70	1.00	4.0	-	-	-	70	1.00	4.0	-	-	-	-	-	-	-	-
	S30	-	40	0.85	4.0	-	-	-	-	-	-	-	-	-	-	-	-	-	-
 Geometry for heavy-rough machining, and continuous to interrupted cuts.																			
RPUX 3010MO*	T9315	-	85	1.00	4.0	-	-	-	80	1.00	4.0	-	-	-	-	-	-	-	-
	T9325	-	75	1.00	4.0	-	-	-	70	1.00	4.0	-	-	-	-	-	-	-	-
	S30	-	40	0.85	4.0	-	-	-	-	-	-	-	-	-	-	-	-	-	-
 Geometry for heavy-rough machining, and continuous to interrupted cuts.																			
RPUX 30-1867000*	6630	-	70	1.00	4.0	-	-	-	65	1.00	4.0	-	-	-	-	-	-	-	-

* Special items



VB/VC

11/ 16

CARBIDE INSERTS

VBMT	VCGT	VCMT
113	116	118

MATCH THE RIGHT SIZE (example)

Insert	Tool Holder
VBMT 160408E-FM	SVHCR 2020 K 16-M-A

SVHB(C)(RL) EXT		SVJB(C)(RL) EXT		SVPB(C)(RL) EXT		SVVB(C)N EXT	
107°30'	VB, VC..	93°	VB, VC..	117°30'	VB, VC..	72°30'	VB, VC..
11 16		11 13 16		11 16		11 13 16	
16×16 25×25		12×12 32×25		16×16 32×25		12×12 32×25	
120	113 – 119	121	113 – 119	123	113 – 119	124	113 – 119
C.-SVHB(RL) EXT		C.-SVJB(RL) EXT		C.-SVVB(N) EXT			
107°30'	VB, VC..	93°	VB, VC..	72°30'	VB, VC..		
16		11 16		16			
C4 C6		C3 C6		C4 C6			
126	113 – 119	127	113 – 119	128	113 – 119		



VBMT



	IC (mm)	D1 (mm)	L (mm)	S (mm)
1102	6.350	2.80	11.10	2.38
1103	6.350	2.80	11.10	3.18
1604	9.525	4.40	16.60	4.76

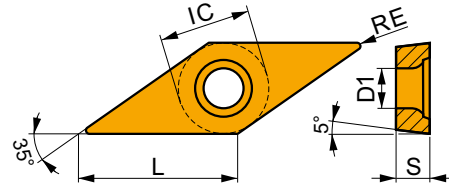

Suitability and starting values for cutting speed (vc), feed (f) and depth of cut (ap). Refer to our Machining Calculator app for further calculations.

Product	RE (mm)	P			M			K			N			S			H		
		vc (m/min)	f (mm/rev)	ap (mm)	vc (m/min)	f (mm/rev)	ap (mm)	vc (m/min)	f (mm/rev)	ap (mm)	vc (m/min)	f (mm/rev)	ap (mm)	vc (m/min)	f (mm/rev)	ap (mm)	vc (m/min)	f (mm/rev)	ap (mm)

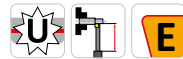
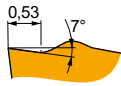

FF2 geometry with positive design for fine-finish to finish machining, and continuous to slightly interrupted cuts.

VBMT 160404E-FF2	T7325	0.4	✓	145	0.12	0.8	–	–	–	–	–	–	–	–	–	–	–	–	–
	T8430	0.4	■	150	0.12	0.8	–	–	–	✓	125	0.12	0.8	–	–	–	–	–	–
	T9315	0.4	■	215	0.12	0.8	–	–	–	✓	200	0.12	0.8	–	–	–	–	–	–
	T9325	0.4	■	190	0.12	0.8	–	–	–	✓	180	0.12	0.8	–	–	–	–	–	–
	T9335	0.4	■	160	0.12	0.8	–	–	–	–	–	–	–	–	–	–	–	–	–

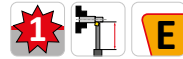
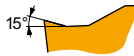





FM geometry for finish to semi-rough machining, and continuous to slightly interrupted cuts.

VBMT 110302E-FM	T7325	0.2	✓	160	0.10	0.8	■	120	0.09	0.8	–	–	–	–	–	–	–	–	–	
	T8315	0.2	✓	145	0.10	0.8	■	85	0.09	0.8	✓	135	0.10	0.8	✓	435	0.12	0.8	–	–
	T8430	0.2	■	170	0.10	0.8	■	90	0.09	0.8	✓	135	0.10	0.8	✓	465	0.12	0.8	–	–
	T9325	0.2	■	210	0.10	0.8	■	125	0.09	0.8	✓	195	0.10	0.8	–	–	–	–	–	–
	T9335	0.2	■	135	0.19	0.8	■	105	0.17	0.8	–	–	–	–	–	–	–	–	–	
VBMT 110304E-FM	T7325	0.4	✓	140	0.19	0.8	■	105	0.17	0.8	–	–	–	–	–	–	–	–	–	
	T7335	0.4	✓	135	0.19	0.8	■	105	0.17	0.8	–	–	–	–	–	–	–	–	–	
	T8315	0.4	✓	145	0.12	0.8	■	85	0.11	0.8	✓	135	0.12	0.8	✓	435	0.14	0.8	–	–
	T8430	0.4	■	170	0.12	0.8	■	90	0.11	0.8	✓	135	0.12	0.8	✓	465	0.14	0.8	–	–
	T9315	0.4	■	235	0.12	0.8	–	–	–	–	✓	220	0.12	0.8	–	–	–	–	–	–
VBMT 110308E-FM	T9325	0.4	■	175	0.19	0.8	■	105	0.17	0.8	✓	165	0.19	0.8	–	–	–	–	–	
	T7325	0.8	✓	170	0.17	0.8	■	130	0.15	0.8	–	–	–	–	–	–	–	–	–	
	T8430	0.8	■	175	0.17	0.8	■	95	0.15	0.8	✓	140	0.17	0.8	✓	480	0.20	0.8	–	–
	T9315	0.8	■	240	0.17	0.8	–	–	–	–	✓	225	0.17	0.8	–	–	–	–	–	
VBMT 160402E-FM	T9325	0.8	■	215	0.17	0.8	■	125	0.15	0.8	✓	200	0.17	0.8	–	–	–	–	–	
	T7325	0.2	✓	150	0.10	1.2	■	115	0.09	1.2	–	–	–	–	–	–	–	–	–	
	T8430	0.2	■	165	0.10	1.2	■	90	0.09	1.2	✓	135	0.10	1.2	✓	450	0.12	1.2	–	–
	T9315	0.2	■	230	0.10	1.2	–	–	–	–	✓	215	0.10	1.2	–	–	–	–	–	
VBMT 160404E-FM	T9325	0.2	■	205	0.10	1.2	■	120	0.09	1.2	✓	190	0.10	1.2	–	–	–	–	–	
	T5315	0.4	✓	225	0.12	1.2	–	–	–	–	✓	210	0.12	1.2	–	–	–	–	–	
	T7325	0.4	✓	130	0.19	1.2	■	100	0.17	1.2	–	–	–	–	–	–	–	–	–	
	T7335	0.4	✓	130	0.19	1.2	■	100	0.17	1.2	–	–	–	–	–	–	–	–	–	
	T8315	0.4	✓	140	0.12	1.2	■	80	0.11	1.2	✓	130	0.12	1.2	✓	420	0.14	1.2	–	–
	T8430	0.4	■	165	0.12	1.2	■	90	0.11	1.2	✓	135	0.12	1.2	✓	450	0.14	1.2	–	–
	T9315	0.4	■	225	0.12	1.2	–	–	–	–	✓	210	0.12	1.2	–	–	–	–	–	
	T9325	0.4	■	165	0.19	1.2	■	95	0.17	1.2	✓	155	0.19	1.2	–	–	–	–	–	

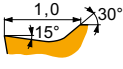

Suitability and starting values for cutting speed (vc), feed (f) and depth of cut (ap). Refer to our Machining Calculator app for further calculations.

Product	RE (mm)	P			M			K			N			S			H			
		vc	f	ap	vc	f	ap	vc	f	ap	vc	f	ap	vc	f	ap	vc	f	ap	
		(m/min)	(mm/rev)	(mm)	(m/min)	(mm/rev)	(mm)	(m/min)	(mm/rev)	(mm)	(m/min)	(mm/rev)	(mm)	(m/min)	(mm/rev)	(mm)	(m/min)	(mm/rev)	(mm)	
						UR geometry for fine to finish machining, and continuous to slightly interrupted cuts.														
VBMT 110202E-UR	TT310	0.2	195	0.10	0.8	115	0.09	0.8	—	—	—	—	—	—	—	—	—	—	—	
VBMT 110204E-UR	T8430	0.4	145	0.12	0.8	80	0.11	0.8	120	0.12	0.8	—	—	—	—	—	—	—	—	
	T9325	0.4	150	0.19	0.8	90	0.17	0.8	140	0.19	0.8	—	—	—	—	—	—	—	—	
VBMT 160402E-UR	T8430	0.2	140	0.10	1.2	75	0.09	1.2	115	0.10	1.2	—	—	—	—	—	—	—	—	
VBMT 160404E-UR	T5315	0.4	195	0.12	1.2	—	—	—	185	0.12	1.2	—	—	—	—	—	—	—	—	
	T7325	0.4	115	0.19	1.2	85	0.17	1.2	—	—	—	—	—	—	—	—	—	—	—	
	T8430	0.4	140	0.12	1.2	75	0.11	1.2	115	0.12	1.2	—	—	—	—	—	—	—	—	
	T9310	0.4	215	0.12	1.2	—	—	—	200	0.12	1.2	—	—	—	—	—	—	—	—	
	T9315	0.4	190	0.12	1.2	—	—	—	180	0.12	1.2	—	—	—	—	—	—	—	—	
	T9325	0.4	145	0.18	1.2	85	0.16	1.2	135	0.18	1.2	—	—	—	—	—	—	—	—	
	TT310	0.4	185	0.12	1.2	110	0.11	1.2	—	—	—	—	—	—	—	—	—	—	—	
VBMT 160408E-UR	T5315	0.8	205	0.17	1.2	—	—	—	190	0.17	1.2	—	—	—	—	—	—	—	—	
	T7325	0.8	140	0.17	1.2	105	0.15	1.2	—	—	—	—	—	—	—	—	—	—	—	
	T8430	0.8	145	0.17	1.2	80	0.15	1.2	120	0.17	1.2	—	—	—	—	—	—	—	—	
	T9310	0.8	220	0.17	1.2	—	—	—	205	0.17	1.2	—	—	—	—	—	—	—	—	
	T9315	0.8	200	0.17	1.2	—	—	—	190	0.17	1.2	—	—	—	—	—	—	—	—	
	T9325	0.8	180	0.17	1.2	105	0.15	1.2	170	0.17	1.2	—	—	—	—	—	—	—	—	
	TT310	0.8	200	0.17	1.2	120	0.15	1.2	—	—	—	—	—	—	—	—	—	—	—	
VBMT 160412E-UR	T8430	1.2	135	0.22	1.2	75	0.20	1.2	110	0.22	1.2	—	—	—	—	—	—	—	—	
	T9310	1.2	205	0.22	1.2	—	—	—	190	0.22	1.2	—	—	—	—	—	—	—	—	
	T9315	1.2	185	0.22	1.2	—	—	—	175	0.22	1.2	—	—	—	—	—	—	—	—	
	T9325	1.2	170	0.22	1.2	100	0.20	1.2	160	0.22	1.2	—	—	—	—	—	—	—	—	



VCGT



	IC	D1	L	S
	(mm)	(mm)	(mm)	(mm)
0702	3.970	2.20	6.90	2.38
1102-SF3	6.350	2.80	11.10	2.58
1103-SF3	6.350	2.80	11.10	3.43
1303	7.940	3.40	13.80	3.18
1303-SF3	7.940	3.40	13.80	3.43
1604-SF3	9.525	4.40	16.60	5.01

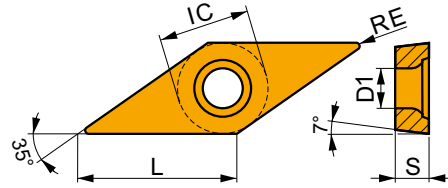

Suitability and starting values for cutting speed (vc), feed (f) and depth of cut (ap). Refer to our Machining Calculator app for further calculations.

Product	RE (mm)	P			M			K			N			S			H		
		vc (m/min)	f (mm/rev)	ap (mm)	vc (m/min)	f (mm/rev)	ap (mm)	vc (m/min)	f (mm/rev)	ap (mm)	vc (m/min)	f (mm/rev)	ap (mm)	vc (m/min)	f (mm/rev)	ap (mm)	vc (m/min)	f (mm/rev)	ap (mm)

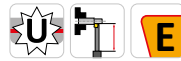
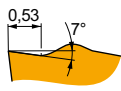

FF2 geometry with positive design for fine-finish to finish machining, and continuous to slightly interrupted cuts.

VCGT 070202E-FF2	T8315	0.2	150	0.05	0.8	—	—	—	140	0.05	0.8	—	—	—	—	—	—	—	—
	T8430	0.2	190	0.05	0.8	—	—	—	155	0.05	0.8	—	—	—	—	—	—	—	—
VCGT 070204E-FF2	T8315	0.4	125	0.12	0.8	—	—	—	115	0.12	0.8	—	—	—	—	—	—	—	—
	T8430	0.4	145	0.12	0.8	—	—	—	120	0.12	0.8	—	—	—	—	—	—	—	—
VCGT 130302E-FF2	T5315	0.2	250	0.05	1.0	—	—	—	235	0.05	1.0	—	—	—	—	—	—	—	—
	T8430	0.2	185	0.05	1.0	—	—	—	150	0.05	1.0	—	—	—	—	—	—	—	—
	T9315	0.2	265	0.05	1.0	—	—	—	250	0.05	1.0	—	—	—	—	—	—	—	—
	T9325	0.2	240	0.05	1.0	—	—	—	225	0.05	1.0	—	—	—	—	—	—	—	—
	TT010	0.2	240	0.05	0.5	—	—	—	—	—	—	—	—	—	—	—	—	—	—
VCGT 130304E-FF2	T5315	0.4	195	0.12	1.0	—	—	—	185	0.12	1.0	—	—	—	—	—	—	—	—
	T7325	0.4	135	0.12	1.0	—	—	—	—	—	—	—	—	—	—	—	—	—	—
	T8430	0.4	140	0.12	1.0	—	—	—	115	0.12	1.0	—	—	—	—	—	—	—	—
	T9315	0.4	195	0.12	1.0	—	—	—	185	0.12	1.0	—	—	—	—	—	—	—	—
	T9325	0.4	175	0.12	1.0	—	—	—	165	0.12	1.0	—	—	—	—	—	—	—	—
	TT010	0.4	245	0.06	0.5	—	—	—	—	—	—	—	—	—	—	—	—	—	—
VCGT 130308E-FF2	T9315	0.8	200	0.17	1.0	—	—	—	190	0.17	1.0	—	—	—	—	—	—	—	—
	T9325	0.8	180	0.17	1.0	—	—	—	170	0.17	1.0	—	—	—	—	—	—	—	—
	TT010	0.8	245	0.10	0.8	—	—	—	—	—	—	—	—	—	—	—	—	—	—

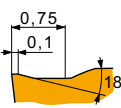

FM2 geometry for finish to medium machining, and continuous to interrupted cuts.

VCGT 130308E-FM2	T8430	0.8	145	0.17	1.0	80	0.15	1.0	120	0.17	1.0	—	—	—	—	—	—	—	—
	T9325	0.8	180	0.17	1.0	105	0.15	1.0	170	0.17	1.0	—	—	—	—	—	—	—	—



NF2 geometry with positive design for fine-finish to semi-rough machining, and continuous cuts.

VCGT 130302E-NF2	H07	0.2	—	—	—	60	0.09	1.0	95	0.10	1.0	310	0.12	1.0	30	0.07	0.8	—	—	—
	T6310	0.2	125	0.07	1.0	90	0.06	1.0	100	0.07	1.0	375	0.08	1.0	35	0.06	0.8	—	—	—
	T7325	0.2	150	0.07	1.0	115	0.06	1.0	—	—	—	—	—	—	45	0.06	0.8	—	—	—
	T7335	0.2	150	0.07	1.0	115	0.06	1.0	—	—	—	—	—	—	45	0.06	0.8	—	—	—
	T9315	0.2	200	0.10	1.0	—	—	—	190	0.10	1.0	—	—	—	—	—	—	—	—	—
	T9325	0.2	210	0.07	1.0	125	0.06	1.0	195	0.07	1.0	—	—	—	45	0.06	0.8	—	—	—
	T9335	0.2	155	0.10	1.0	90	0.09	1.0	—	—	—	—	—	—	30	0.07	0.8	—	—	—
	TT010	0.2	240	0.05	0.5	140	0.05	0.5	—	—	—	—	—	—	—	—	—	—	—	—



Suitability and starting values for cutting speed (vc), feed (f) and depth of cut (ap). Refer to our Machining Calculator app for further calculations.

Product	RE (mm)	P			M			K			N			S			H		
		vc	f	ap	vc	f	ap	vc	f	ap	vc	f	ap	vc	f	ap	vc	f	ap
		(m/min)	(mm/rev)	(mm)	(m/min)	(mm/rev)	(mm)	(m/min)	(mm/rev)	(mm)	(m/min)	(mm/rev)	(mm)	(m/min)	(mm/rev)	(mm)	(m/min)	(mm/rev)	(mm)

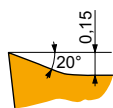

SF3 geometry with highly positive design for fine to finish machining, and continuous cuts.

VCGT 160402E-SF3	T6310	0.2	✓ 145	0.05	0.8	✗ 100	0.05	0.8	✗ 115	0.05	0.8	✗ 435	0.06	0.8	✗ 40	0.04	0.6	✗ 25	0.05	0.2
VCGT 160404E-SF3	H07	0.4	—	—	—	✗ 65	0.09	1.0	✗ 105	0.10	1.0	✗ 335	0.12	1.0	✗ 30	0.07	0.8	—	—	—
	T6310	0.4	✓ 125	0.10	1.0	✗ 90	0.09	1.0	✗ 100	0.10	1.0	✗ 375	0.12	1.0	✗ 35	0.07	0.8	✗ 25	0.07	0.3
	T8315	0.4	✓ 130	0.10	1.0	✗ 75	0.09	1.0	✗ 120	0.10	1.0	✗ 390	0.12	1.0	✗ 30	0.07	0.8	✗ 25	0.07	0.3
VCGT 160408E-SF3	H07	0.8	—	—	—	✗ 75	0.09	1.2	✗ 120	0.10	1.2	✗ 390	0.12	1.2	✗ 35	0.08	1.0	—	—	—
	T6310	0.8	✓ 145	0.10	1.2	✗ 100	0.09	1.2	✗ 115	0.10	1.2	✗ 435	0.12	1.2	✗ 40	0.08	1.0	✗ 25	0.08	0.7
	T8315	0.8	✓ 155	0.10	1.2	✗ 90	0.09	1.2	✗ 145	0.10	1.2	✗ 465	0.12	1.2	✗ 35	0.08	1.0	✗ 30	0.08	0.7
VCGT 160412E-SF3	H07	1.2	—	—	—	✗ 60	0.18	1.2	✗ 95	0.20	1.2	✗ 310	0.24	1.2	✗ 30	0.14	1.0	—	—	—
	T6310	1.2	✓ 125	0.20	1.2	✗ 90	0.18	1.2	✗ 100	0.20	1.2	✗ 375	0.24	1.2	✗ 35	0.14	1.0	✗ 25	0.10	0.9

VCMT



IC	D1	L	S
(mm)	(mm)	(mm)	(mm)

1103	6.350	2.80	11.10	3.18
1604	9.525	4.40	16.60	4.76

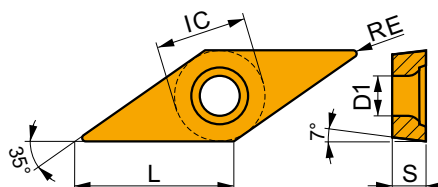

Suitability and starting values for cutting speed (vc), feed (f) and depth of cut (ap). Refer to our Machining Calculator app for further calculations.

Product	RE (mm)	P			M			K			N			S			H		
		vc	f	ap	vc	f	ap	vc	f	ap	vc	f	ap	vc	f	ap	vc	f	ap
		(m/min)	(mm/rev)	(mm)	(m/min)	(mm/rev)	(mm)	(m/min)	(mm/rev)	(mm)	(m/min)	(mm/rev)	(mm)	(m/min)	(mm/rev)	(mm)	(m/min)	(mm/rev)	(mm)

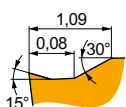

FM geometry for finish to semi-rough machining, and continuous to slightly interrupted cuts.

VCMT 160404E-FM	T7325	0.4	✓ 125	0.19	1.2	✗ 95	0.17	1.2	—	—	—	—	—	—	—	—	—	—	—	—
	T8430	0.4	✗ 150	0.12	1.2	✗ 80	0.11	1.2	✗ 125	0.12	1.2	✓ 420	0.14	1.2	—	—	—	—	—	—
	T9315	0.4	✗ 210	0.12	1.2	—	—	—	✗ 195	0.12	1.2	—	—	—	—	—	—	—	—	—
	T9325	0.4	✗ 155	0.19	1.2	✗ 90	0.17	1.2	✗ 145	0.19	1.2	—	—	—	—	—	—	—	—	—
VCMT 160408E-FM	T7325	0.8	✓ 155	0.17	1.2	✗ 120	0.15	1.2	—	—	—	—	—	—	—	—	—	—	—	—
	T8430	0.8	✗ 155	0.17	1.2	✗ 85	0.15	1.2	✗ 130	0.17	1.2	✓ 435	0.20	1.2	—	—	—	—	—	—
	T9315	0.8	✗ 220	0.17	1.2	—	—	—	✗ 205	0.17	1.2	—	—	—	—	—	—	—	—	—
	T9325	0.8	✗ 195	0.17	1.2	✗ 115	0.15	1.2	✗ 185	0.17	1.2	—	—	—	—	—	—	—	—	—

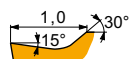

UR geometry for fine to finish machining, and continuous to slightly interrupted cuts.

VCMT 110304E-UR	T7325	0.4	✓ 110	0.19	0.8	✓ 85	0.17	0.8	—	—	—	—	—	—	—	—	—	—	—	—
	T8430	0.4	✗ 135	0.12	0.8	✓ 75	0.11	0.8	✗ 110	0.12	0.8	—	—	—	—	—	—	—	—	—
	T9315	0.4	✗ 190	0.12	0.8	—	—	—	✗ 180	0.12	0.8	—	—	—	—	—	—	—	—	—
	T9325	0.4	✗ 140	0.19	0.8	✓ 80	0.17	0.8	✗ 130	0.19	0.8	—	—	—	—	—	—	—	—	—
VCMT 110308E-UR	T7325	0.8	✓ 140	0.17	0.8	✓ 105	0.15	0.8	—	—	—	—	—	—	—	—	—	—	—	—
	T8430	0.8	✗ 140	0.17	0.8	✓ 75	0.15	0.8	✗ 115	0.17	0.8	—	—	—	—	—	—	—	—	—
	T9315	0.8	✗ 195	0.17	0.8	—	—	—	✗ 185	0.17	0.8	—	—	—	—	—	—	—	—	—
	T9325	0.8	✗ 175	0.17	0.8	✓ 105	0.15	0.8	✗ 165	0.17	0.8	—	—	—	—	—	—	—	—	—



Suitability and starting values for cutting speed (vc), feed (f) and depth of cut (ap). Refer to our Machining Calculator app for further calculations.

Product	RE (mm)	P			M			K			N			S			H		
		vc (m/min)	f (mm/rev)	ap (mm)	vc (m/min)	f (mm/rev)	ap (mm)	vc (m/min)	f (mm/rev)	ap (mm)	vc (m/min)	f (mm/rev)	ap (mm)	vc (m/min)	f (mm/rev)	ap (mm)	vc (m/min)	f (mm/rev)	ap (mm)

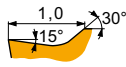

UR geometry for fine to finish machining, and continuous to slightly interrupted cuts.

VCMT 160404E-UR	T7325	0.4	110	0.19	1.2	85	0.17	1.2	-	-	-	-	-	-	-	-	-	-	
	T8430	0.4	130	0.12	1.2	70	0.11	1.2	105	0.12	1.2	-	-	-	-	-	-	-	
	T9315	0.4	180	0.12	1.2	-	-	-	170	0.12	1.2	-	-	-	-	-	-	-	-
	T9325	0.4	135	0.19	1.2	80	0.17	1.2	125	0.19	1.2	-	-	-	-	-	-	-	-
VCMT 160408E-UR	T7325	0.8	135	0.17	1.2	105	0.15	1.2	-	-	-	-	-	-	-	-	-	-	
	T8430	0.8	135	0.17	1.2	75	0.15	1.2	110	0.17	1.2	-	-	-	-	-	-	-	
	T9315	0.8	190	0.17	1.2	-	-	-	180	0.17	1.2	-	-	-	-	-	-	-	-
	T9325	0.8	170	0.17	1.2	100	0.15	1.2	160	0.17	1.2	-	-	-	-	-	-	-	-



SVHB(C)(RL) EXT



PRAMET

S



Ext. Screw Lock Tool Holder with 107.5° Cutting Angle for VB/VC.. Inserts

External Right/Left hand tool holder for screw type positive VB.. 11 or 16 and VC.. 11 or 16 inserts. Suited for external face and longitudinal turning with shoulder, taper, face and longitudinal copy turning up to 35° and chamfer turning. Available with shank size 16x16 up to 25x25 mm. Body treated for longer tool life.

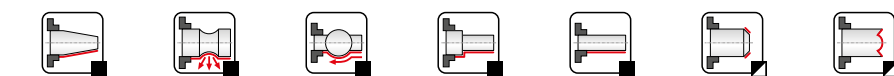
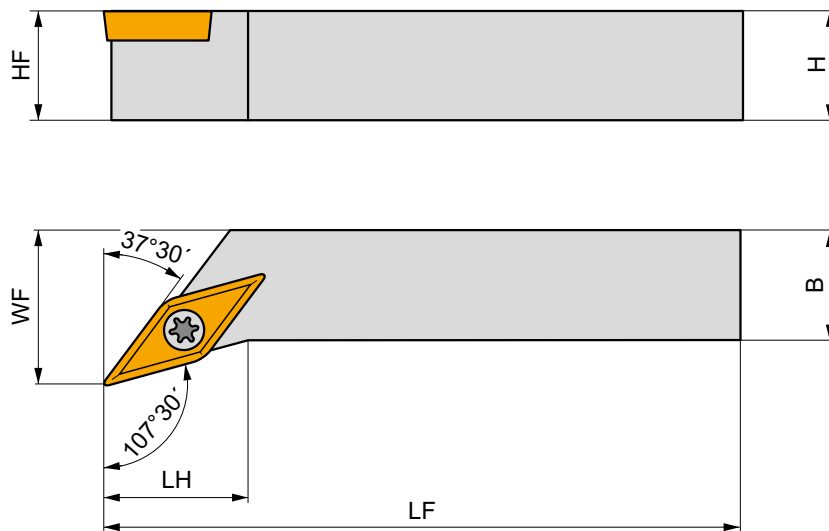
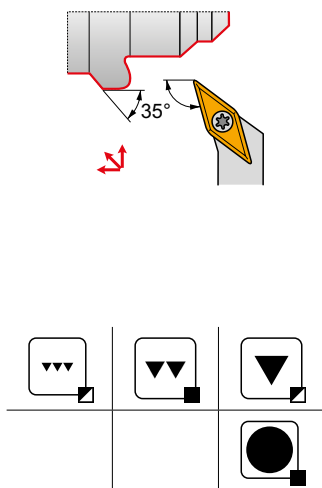

Product	H	B	HF	WF	LF	LH	LAMS	GAMO	kg	GI	SV
	(mm)	(mm)	(mm)	(mm)	(mm)	(mm)	(°)	(°)			
R SVHBR 1616 H 11	16	16	16	20	100	14	0	0	0.21	GI194	S01
SVHCR 2020 K 16-M-A	20	20	20	25	125	20	0	0	0.40	GI017	SV10
SVHCR 2525 M 16-M-A	25	25	25	32	150	20	0	0	0.68	GI017	SV10
L SVHBL 1616 H 11	16	16	16	20	100	14	0	0	0.19	GI194	S01
SVHCL 2020 K 16-M-A	20	20	20	25	125	20	0	0	0.40	GI017	SV10
SVHCL 2525 M 16-M-A	25	25	25	32	150	20	0	0	0.07	GI017	SV10

GI	VB..	VC..
GI017	VB.. 1604..	VC.. 1604..
GI194	VB.. 1103..	VC.. 1103..

SV	US	Nm	M	mm	SVN	MS	FLAG	HXK
S01	US 2506-T07P	0.9	M 2.5	6.3	-	-	FLAG T07P	-
SV10	US 3512-T15P	3.0	M 3.5	12.6	SVN 160304	MS 3510	FLAG T15P	HXK 3.5



SVJB(C)(RL) EXT

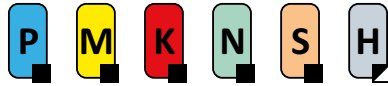

External Screw Lock Tool Holder with 93° Cutting Angle for VB/VC.. Inserts

External Right/Left hand tool holder for screw type positive VB.. 11 or 16 and VC.. 11 up to 16 inserts. Suited for external longitudinal shoulder, taper, chamfer and copy turning up to 50°. Available in shank size 12 × 12 up to 32 × 25 mm, with some usable for sliding head machines. Body treated for longer tool life.

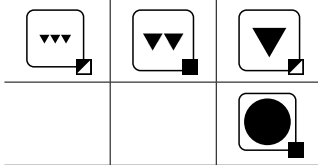
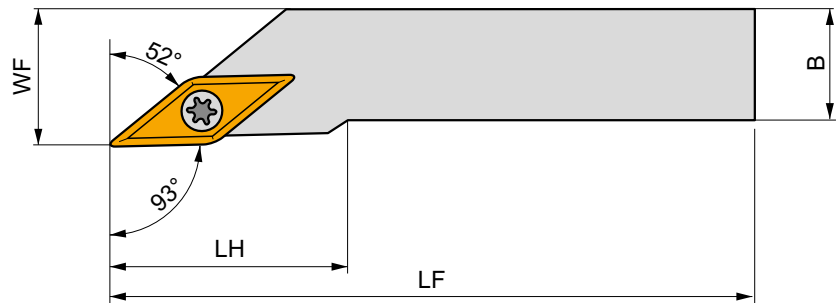
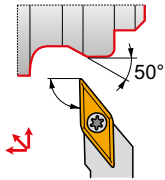

Product	H (mm)	B (mm)	HF (mm)	WF (mm)	LF (mm)	LH (mm)	LAMS (°)	GAMO (°)	kg		
R SVJBR 1212 F 11	12	12	12	16	80	20	0	0	0.09	G1194	S01
SVJBR 1616 H 11	16	16	16	20	100	20	0	0	0.20	G1194	S01
SVJCR 1212 N 13	12	12	12	16	160	27	0	0	0.19	G1211	SV21
SVJCR 1616 H 13	16	16	16	20	100	30	0	0	0.20	G1211	SV21
SVJCR 2020 K 13	20	20	20	25	125	30	0	0	0.37	G1211	SV22
SVJCR 2020 K 16-M-A	20	20	20	25	125	28	0	0	0.35	G1017	SV10
SVJCR 2525 M 13	25	25	25	32	150	30	0	0	0.67	G1211	SV22
SVJCR 2525 M 16-M-A	25	25	25	32	150	32	0	0	0.68	G1017	SV10
SVJCR 3225 P 16-M-A	32	25	32	32	170	32	0	0	0.99	G1017	SV10
L SVJBL 1212 F 11	12	12	12	16	80	20	0	0	0.09	G1194	S01
SVJBL 1616 H 11	16	16	16	20	100	20	0	0	0.19	G1194	S01
SVJCL 1212 N 13	12	12	12	16	160	27	0	0	0.19	G1211	SV21
SVJCL 1616 H 13	16	16	16	20	100	30	0	0	0.20	G1211	SV21
SVJCL 2020 K 13	20	20	20	25	125	30	0	0	0.37	G1211	SV22
SVJCL 2020 K 16-M-A	20	20	20	25	125	28	0	0	0.40	G1017	SV10
SVJCL 2525 M 13	25	25	25	32	150	30	0	0	0.67	G1211	SV22
SVJCL 2525 M 16-M-A	25	25	25	32	150	32	0	0	0.70	G1017	SV10
SVJCL 3225 P 16-M-A	32	25	32	32	170	32	0	0	0.99	G1017	SV10



G1017
G1194
G1211

VB.. 1604..
VB.. 1103..

-

VC.. 1604..
VC.. 1103..
VC.. 1303..

OP









RC

RP

VB

VC



								
S01	US 2506-T07P	0.9	M 2.5	6.3	–	–	FLAG T07P	–
SV10	US 3512-T15P	3.0	M 3.5	12.6	SVN 160304	MS 3510	FLAG T15P	HXK 3.5
SV21	5513 020-24	1.5	M 3	8.5	–	–	PT-8002	–
SV22	DVF 0573	1.5	M 3	10.3	DAP 0331	DVT 0332	PT-8002	174.1-870



SVPB(C)(RL) EXT

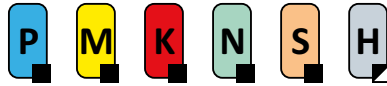

PRAMET

S



External Screw Lock Tool Holder, 117.5° Cutting Angle for VB/VC.. Inserts

External Right/Left hand tool holder for screw type positive VB.. 11 or 16 and VC.. 11 or 16 inserts. Suited for external face and longitudinal turning with shoulder, taper, face copy turning up to 25° and chamfer turning. Available with shank size 16x16 up to 32x25 mm. Body treated for longer tool life.

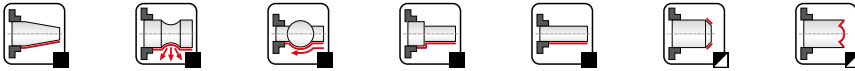
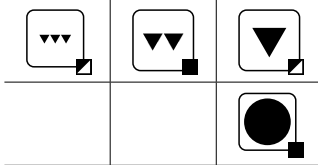
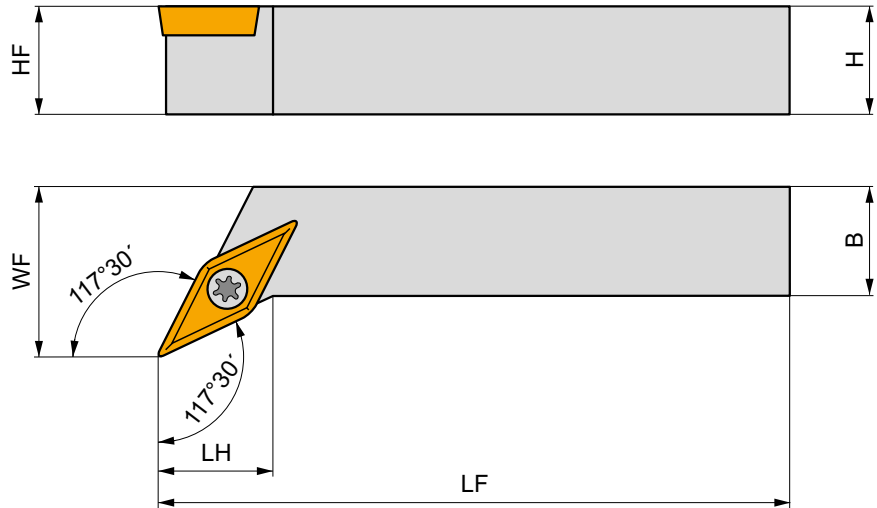
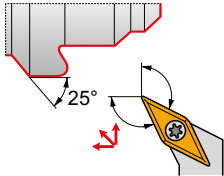

Product	H (mm)	B (mm)	HF (mm)	WF (mm)	LF (mm)	LH (mm)	LAMS (°)	GAMO (°)	kg	GI	SV
R SVPBR 1616 H 11	16	16	16	20	100	12	0	0	0.20	GI194	SO1
SVPBR 2020 K 11	20	20	20	25	125	12	0	0	0.41	GI194	SO1
SVPCR 2020 K 16-M-A	20	20	20	25	125	20	0	0	0.40	GI017	SV10
SVPCR 2525 M 16-M-A	25	25	25	32	150	25	0	0	0.75	GI017	SV10
SVPCR 3225 P 16-M-A	32	25	32	32	170	25	0	0	1.10	GI017	SV10
L SVPBL 1616 H 11	16	16	16	20	100	12	0	0	0.20	GI194	SO1
SVPBL 2020 K 11	20	20	20	25	125	12	0	0	0.39	GI194	SO1
SVPCL 2020 K 16-M-A	20	20	20	25	125	20	0	0	0.70	GI017	SV10
SVPCL 2525 M 16-M-A	25	25	25	32	150	25	0	0	0.70	GI017	SV10
SVPCL 3225 P 16-M-A	32	25	32	32	170	25	0	0	1.10	GI017	SV10

GI017
GI194VB.. 1604..
VB.. 1103..VC.. 1604..
VC.. 1103..SO1
SV10US 2506-T07P
US 3512-T15P0.9
3.0M 2.5
M 3.56.3
12.6-
SVN 160304-
MS 3510FLAG T07P
FLAG T15P-
HXK 3.5



SVVB(C)N EXT

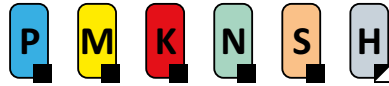

PRAMET

S



External Screw Lock Tool Holder, 72.5° Cutting Angle for VB/VC.. Inserts

External neutral tool holder for screw type positive VB.. 11 or 16 and VC.. 11 up to 16 inserts. Suited for external longitudinal turning without shoulder, taper, copy turning up to 72.5° and chamfer turning. Available with shank size 12x12 up to 32x25 mm. Body treated for longer tool life.

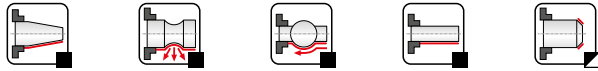
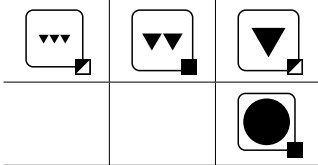
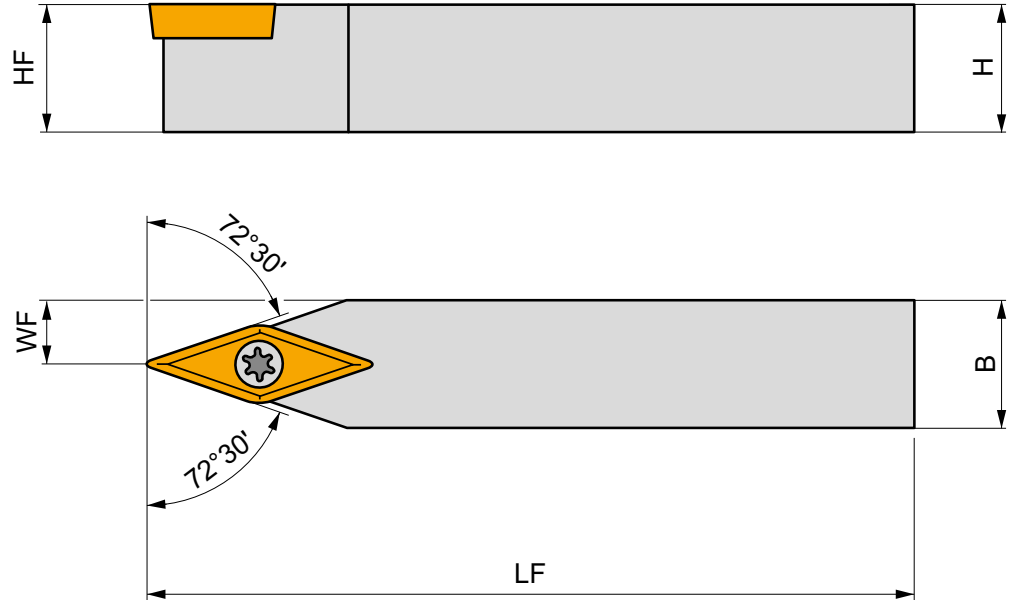
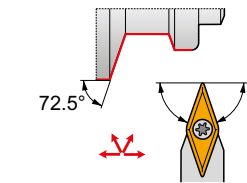

Product	H	B	HF	WF	LF	LH	LAMS	GAMO	kg		
	(mm)	(mm)	(mm)	(mm)	(mm)	(mm)	(°)	(°)			
SVVBN 1212 F 11	12	12	12	6	80	–	0	0	0.11	GI194	S01
SVVBN 1616 H 11	16	16	16	8	100	–	0	0	0.18	GI194	S01
SVVBN 2020 K 11	20	20	20	10	125	–	0	0	0.38	GI194	S01
SVVCN 1212 N 13	12	12	12	6	160	–	0	0	0.19	GI211	SV21
SVVCN 1616 H 13	16	16	16	8	100	–	0	0	0.20	GI211	SV21
SVVCN 2020 K 13	20	20	20	10	125	–	0	0	0.36	GI211	SV22
SVVCN 2525 M 13	25	25	25	12.5	150	–	0	0	0.66	GI211	SV22
SVVCN 2020 K 16-M-A	20	20	20	10	125	–	0	0	0.34	GI017	SV10
SVVCN 2525 M 16-M-A	25	25	25	12.5	150	–	0	0	0.68	GI017	SV10
SVVCN 3225 P 16-M-A	32	25	32	12.5	170	–	0	0	0.97	GI017	SV10

GI017	VB.. 1604..	VC.. 1604..
GI194	VB.. 1103..	VC.. 1103..
GI211	–	VC.. 1303..

S01	US 2506-T07P	0.9	M 2.5	6.3	–	–	FLAG T07P	–
SV10	US 3512-T15P	3.0	M 3.5	12.6	SVN 160304	MS 3510	FLAG T15P	HXK 3.5
SV21	5513 020-24	1.5	M 3	8.5	–	–	PT-8002	–
SV22	DVF 0573	1.5	M 3	10.3	DAP 0331	DVT 0332	PT-8002	174.1-870



SVXB(C)(RL) EXT

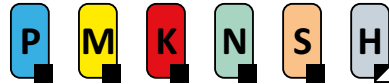

PRAMET

S

External Screw Lock Tool Holder 98/113° Cutting Angle for VB/VC.. Inserts

External Right/Left hand tool holder for screw type positive VB.. 11 or 16 and VC.. 11 up to 16 inserts. Suited for external longitudinal turning with shoulder, taper, copy turning up to 30° and chamfer turning. Available with shank size 12x12 up to 32x25 mm. Body treated for longer tool life.

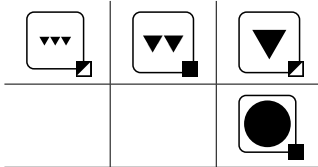
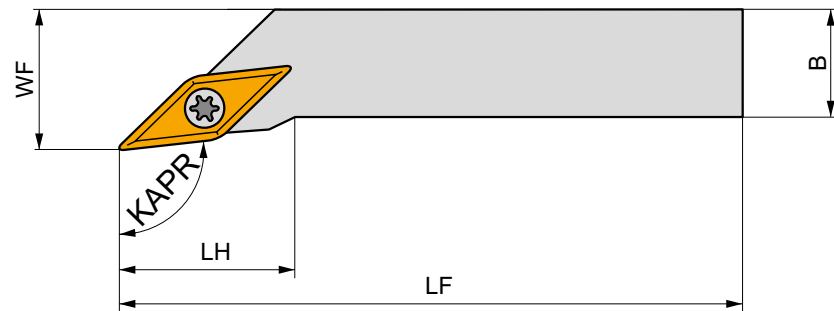
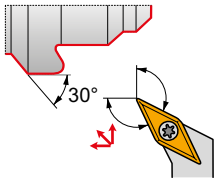

Product	H	B	HF	WF	LF	LH	KAPR	LAMS	GAMO	kg		
	(mm)	(mm)	(mm)	(mm)	(mm)	(mm)	(°)	(°)	(°)			
SVXBR 1212 F 11	12	12	12	16	80	20	98	0	0	0.09	GI194	S01
SVXBR 1616 H 11	16	16	16	20	100	14	98	0	0	0.19	GI194	S01
R SVXCR 2020 K 13	20	20	20	25	125	12	113	0	0	0.38	GI211	SV22
SVXCR 2020 K 16-M-A	20	20	20	25	125	28	98	0	0	0.41	GI017	SV10
SVXCR 2525 M 16-M-A	25	25	25	32	150	32	98	0	0	0.68	GI017	SV10
SVXCR 3225 P 16-M-A	32	25	32	32	170	32	98	0	0	1.00	GI017	SV10
SVXBL 1212 F 11	12	12	12	16	80	20	98	0	0	0.09	GI194	S01
SVXBL 1616 H 11	16	16	16	20	100	14	98	0	0	0.19	GI194	S01
L SVXCL 2020 K 13	20	20	20	25	125	12	113	0	0	0.38	GI211	SV22
SVXCL 2020 K 16-M-A	20	20	20	25	125	28	98	0	0	0.38	GI017	SV10
SVXCL 2525 M 16-M-A	25	25	25	32	150	32	98	0	0	0.69	GI017	SV10
SVXCL 3225 P 16-M-A	32	25	32	32	170	32	98	0	0	0.99	GI017	SV10

GI017	VB.. 1604.. VC.. 1604..
GI194	VB.. 1103.. VC.. 1103..
GI211	- VC.. 1303..

S01	US 2506-T07P	0.9	M 2.5	6.3	-	-	FLAGT07P	-			
SV10	US 3512-T15P	3.0	M 3.5	12.6	SVN 160304	MS 3510	FLAGT15P	HXK 3.5			
SV22	DVF 0573	1.5	M 3	10.3	DAP 0331	DVT 0332	PT-8002	174.1-870			



C.-SVHB(RL) EXT



PRAMET

S



Ext. PSC Quick Change Tool, Screw Lock, 107.5° Cutting Angle, VB/VC.. Inserts

External Right/Left hand tool, through coolant, for screw type positive VB.. 16 and VC.. 16 inserts. Suited for external longitudinal turning with shoulder, taper, copy turning up to 35° and chamfer turning. Available with PSC (Polygon Shank Coupling) size C4 up to C6. Body treated for longer tool life.

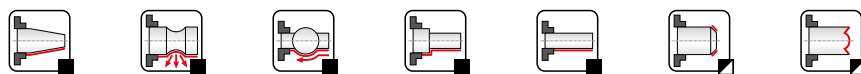
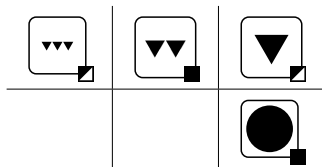
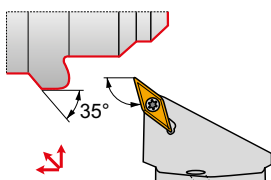
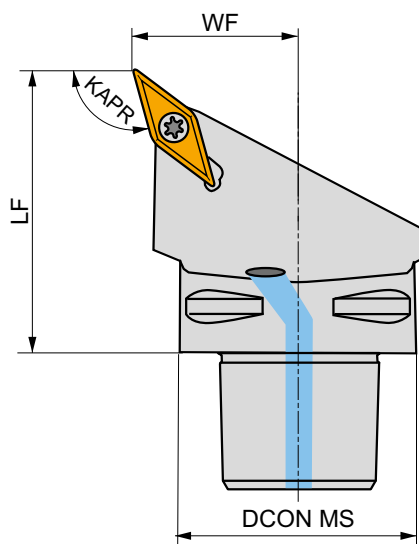

Product	DCON MS (mm)	WF (mm)	LF (mm)	KAPR (°)	LAM S (°)	GAMO (°)		kg		
R C4-SVHBR-27050-16	40	27	50	107.5	0	0	✓	0.35	GI017	C-SV16S-1
C5-SVHBR-35060-16	50	35	60	107.5	0	0	✓	0.64	GI017	C-SV16S-2
C6-SVHBR-45065-16	63	45	65	107.5	0	0	✓	1.13	GI017	C-SV16S-2
L C4-SVHBL-27050-16	40	27	50	107.5	0	0	✓	0.35	GI017	C-SV16S-1
C5-SVHBL-35060-16	50	35	60	107.5	0	0	✓	0.64	GI017	C-SV16S-2
C6-SVHBL-45065-16	63	45	65	107.5	0	0	✓	1.12	GI017	C-SV16S-2

GI017	VB.. 1604..	VC.. 1604..

C-SV16S-1	US 2001-T15P	3.0	M 3.5	12.1	SVS 270-01	MS 9001	FLAG T15P/3,5	CN 034-01
C-SV16S-2	US 2001-T15P	3.0	M 3.5	12.1	SVS 270-01	MS 9001	FLAG T15P/3,5	CN 034-02



C.-SVJB(RL) EXT

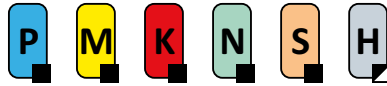

Ext. PSC Quick Change Tool, Screw Lock, 93° Cutting Angle for VB/VC.. Inserts

External Right/Left hand tool, through coolant, for screw type positive VB.. 11 or 16 and VC.. 11 up to 16 inserts. Suited for external longitudinal turning with shoulder, taper, copy turning up to 50° and chamfer turning. Available with PSC (Polygon Shank Coupling) size C3 up to C6. Body treated for longer tool life.

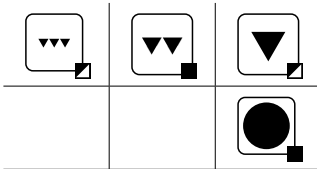
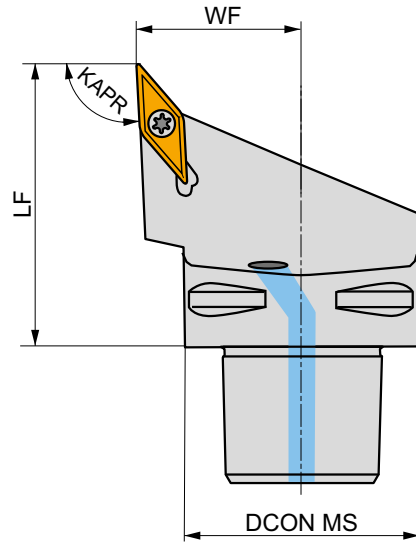
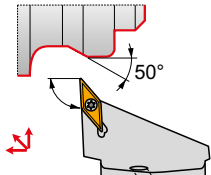

Product	DCON MS (mm)	WF (mm)	LF (mm)	KAPR (°)	LAMS (°)	GAMO (°)				
R C3-SVJBR-22040-11-B1	32	22	40	93	0	0	✓	0.17	GI194	C-SV11
C4-SVJBR-27050-11-B1	40	27	50	93	0	0	✓	0.34	GI194	C-SV11
C4-SVJBR-27050-16	40	27	50	93	0	0	✓	0.35	GI017	C-SV16S-1
C5-SVJBR-35060-16	50	35	60	93	0	0	✓	0.63	GI017	C-SV16S-2
C6-SVJBR-45065-16	63	45	65	93	0	0	✓	1.11	GI017	C-SV16S-2
L C4-SVJBL-27050-16	40	27	50	93	0	0	✓	0.34	GI017	C-SV16S-1
C5-SVJBL-35060-16	50	35	60	93	0	0	✓	0.64	GI017	C-SV16S-2
C6-SVJBL-45065-16	63	45	65	93	0	0	✓	1.11	GI017	C-SV16S-2

GI017	VB.. 1604..	VC.. 1604..
GI194	VB.. 1103..	VC.. 1103..

C-SV11	US 2003-T07P	0.8	M 2.5	6.5	-	-	FLAG T07P	CN 034-01
C-SV16S-1	US 2001-T15P	3.0	M 3.5	12.1	SVS 270-01	MS 9001	FLAG T15P/3,5	CN 034-01
C-SV16S-2	US 2001-T15P	3.0	M 3.5	12.1	SVS 270-01	MS 9001	FLAG T15P/3,5	CN 034-02



C.-SVVBN EXT



PRAMET

S



Ext. PSC Quick Change Tool, Screw Lock, 72.5° Cutting Angle, VB/VC.. Inserts

External neutral tool, through coolant, for screw type positive VB.. 16 and VC.. 16 inserts. Suited for external longitudinal turning without shoulder, taper, copy turning up to 72.5° and chamfer turning. Available with PSC (Polygon Shank Coupling) size C4 up to C6. Body treated for longer tool life.

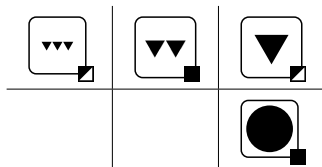
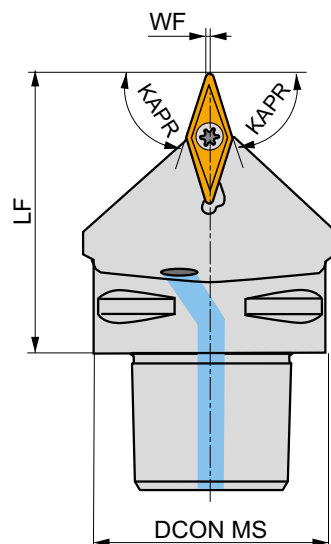
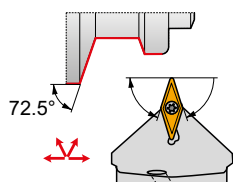

Product	DCON MS (mm)	WF (mm)	LF (mm)	KAPR (°)	LAMS (°)	GAMO (°)		kg		
N C4-SVVBN-00050-16	40	0.6	50	72.5	0	0	✓	0.32	GI017	C-SV16S-1
C5-SVVBN-00060-16	50	0.6	60	72.5	0	0	✓	0.56	GI017	C-SV16S-2
C6-SVVBN-00065-16	63	0.6	65	72.5	0	0	✓	0.99	GI017	C-SV16S-2

GI017	VB.. 1604..	VC.. 1604..

C-SV16S-1	US 2001-T15P	3.0	M 3.5	12.1	SVS 270-01	MS 9001	FLAG T15P/3,5	CN 034-01
C-SV16S-2	US 2001-T15P	3.0	M 3.5	12.1	SVS 270-01	MS 9001	FLAG T15P/3,5	CN 034-02



NEGATIVE INSERTS



BN

20

CARBIDE INSERTS

BNMX



131



BNMX 20

	W1 (mm)	L (mm)	S (mm)
2015	12.000	20.00	15.00

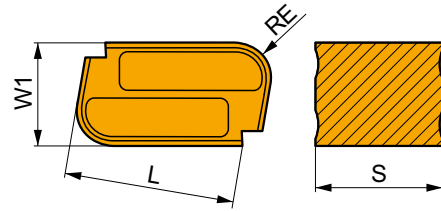

Suitability and starting values for cutting speed (vc), feed (f) and depth of cut (ap). Refer to our Machining Calculator app for further calculations.

Product	RE (mm)	P			M			K			N			S			H		
		vc (m/min)	f (mm/rev)	ap (mm)	vc (m/min)	f (mm/rev)	ap (mm)	vc (m/min)	f (mm/rev)	ap (mm)	vc (m/min)	f (mm/rev)	ap (mm)	vc (m/min)	f (mm/rev)	ap (mm)	vc (m/min)	f (mm/rev)	ap (mm)

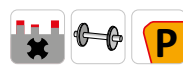
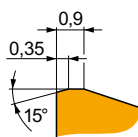

Geometry for rough to heavy-rough machining, and continuous to interrupted cuts.

BNMX 201540*	S30	4.0	40	0.85	4.0	-	-	-	-	-	-	-	-	-	-	-	-	-
---------------------	------------	-----	----	------	-----	---	---	---	---	---	---	---	---	---	---	---	---	---

* Special items



CN

09/ 12/ 16/ 19/ 25

CARBIDE INSERTS

CNMG	CNMM	CNMX 19
134	143	145

MATCH THE RIGHT SIZE (example)

Insert	Tool Holder
CNMM 120412E-OR	DCBNR 2525 M 12

DCBN(RL) EXT 75° CN.. 12 16 19 20×20 40×40 147 134 – 146	DCLN(RL) EXT 95° CN.. 09 12 16 19 16×16 40×40 149 134 – 146	PCBN(RL) EXT 75° CN.. 12 16 19 25 20×20 50×50 151 134 – 146	PCLN(RL) EXT 95° CN.. 12 16 19 25 20×20 50×50 153 134 – 146
C-DCLN(RL) EXT 95° CN.. 12 16 19 C3 C8 155 134 – 146	KHP-CBNR + DKH(RL) 75° CN.. 25 40×50 60×80 DKHR+KHP-CBNR 157 134 – 146	KHP-CBNL + DKH(RL) 75° CN.. 25 40×50 60×80 DKHR+KHP-CBNL 157 134 – 146	KHP-CLNR/L + DKH(RL) 95° CN.. 19 25 40×50 60×80 DKHR+KHP-CLNR 158 134 – 146
DKT(RL)-A1 + KTP CN.. 19 KTP-CAN(RL) 50×55 160 134 – 146, 167	DKT(RL)-A2 + KTP CN.. 19 KTP-CAN(RL) KTP-CFN(RL) 50×55 160 134 – 146, 167 – 168	DKT(RL)-B1 + KTP CN.. 19 KTP-CAN(RL) 50×49.5 161 134 – 146, 167	DKT(RL)-B2 + KTP CN.. 19 KTP-CAN(RL) KTP-CFN(RL) 50×49.5 161 134 – 146, 167 – 168



CN

09/ 12/ 16/ 19/ 25

DKT(RL)-C1 + KTP	
	CN..
	19
	KTP-CAN(RL)
	55x55
	134 – 146, 167
	XX

DKT(RL)-C2 + KTP	
	CN..
	19
	KTP-CAN(RL) KTP-CFN(RL)
	55x55 55x52
	134 – 146, 167 – 168
	162

DKT(RL)-D1 + KTP	
	CN..
	19
	KTP-CAN(RL)
	50x49.5
	134 – 146, 167
	162

DKT(RL)-D2 + KTP	
	CN..
	19
	KTP-CAN(RL) KTP-CFN(RL)
	50x49.5
	134 – 146, 167 – 168
	163

S-DKT(RL)4065X-C	
	CN..
	19
	45x65
	134 – 146
	163

S-DKT(RL)4065X + KTP	
	CN..
	19
	KTP-CAN(RL) KTP-CFN(RL)
	45x65
	134 – 146, 167 – 168
	165

S-DKT(RL)5556 + KTP	
	CN..
	19
	KTP-CAN(RL) KTP-CFN(RL)
	56x55
	134 – 146, 167 – 168
	166



CNMG

IC	D1	L	S	
				(mm)
0903	9.525	3.81	9.70	3.18
1204	12.700	5.16	12.90	4.76
1606	15.880	6.35	16.10	6.35
1906	19.050	7.94	19.30	6.35
2509	25.400	9.12	25.80	9.53

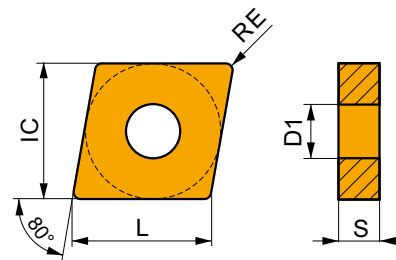

Suitability and starting values for cutting speed (vc), feed (f) and depth of cut (ap). Refer to our Machining Calculator app for further calculations.

Product	RE (mm)	P			M			K			N			S			H		
		vc (m/min)	f (mm/rev)	ap (mm)	vc (m/min)	f (mm/rev)	ap (mm)	vc (m/min)	f (mm/rev)	ap (mm)	vc (m/min)	f (mm/rev)	ap (mm)	vc (m/min)	f (mm/rev)	ap (mm)	vc (m/min)	f (mm/rev)	ap (mm)

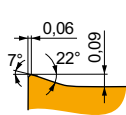

FF geometry with highly positive design for fine-finish machining, and continuous to slightly interrupted cuts.

CNMG 120404E-FF	T7325	0.4	235	0.12	1.0	180	0.11	1.0	—	—	—	—	—	—	—	—	—	—
	T8315	0.4	220	0.12	1.0	130	0.11	1.0	205	0.12	1.0	—	—	—	—	—	—	—
CNMG 120408E-FF	T7325	0.8	265	0.15	1.0	205	0.14	1.0	—	—	—	—	—	—	—	—	—	—
	T8315	0.8	245	0.15	1.0	145	0.14	1.0	230	0.15	1.0	—	—	—	—	—	—	—

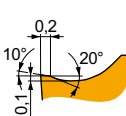

FM geometry with positive design for finish to semi-rough machining, and continuous to slightly interrupted cuts.

CNMG 090304E-FM	T8430	0.4	195	0.20	1.4	105	0.18	1.4	160	0.20	1.4	—	—	—	40	0.14	1.1	—	—	—
	T9315	0.4	265	0.20	1.4	—	—	—	250	0.20	1.4	—	—	—	—	—	—	—	—	—
	T9325	0.4	240	0.20	1.4	140	0.18	1.4	225	0.20	1.4	—	—	—	50	0.16	1.1	—	—	—
CNMG 090308E-FM	T8430	0.8	235	0.20	1.4	125	0.18	1.4	190	0.20	1.4	—	—	—	50	0.14	1.1	—	—	—
	T9315	0.8	315	0.20	1.4	—	—	—	295	0.20	1.4	—	—	—	—	—	—	—	—	—
	T9325	0.8	285	0.20	1.4	170	0.18	1.4	270	0.20	1.4	—	—	—	60	0.16	1.1	—	—	—
CNMG 120404E-FM	T7325	0.4	185	0.20	2.1	140	0.18	2.1	—	—	—	—	—	—	60	0.16	1.7	—	—	—
	T7335	0.4	180	0.20	2.1	140	0.18	2.1	—	—	—	—	—	—	55	0.16	1.7	—	—	—
	T8315	0.4	175	0.20	2.1	105	0.18	2.1	165	0.20	2.1	—	—	—	40	0.14	1.7	—	—	—
	T8430	0.4	190	0.20	2.1	105	0.18	2.1	155	0.20	2.1	—	—	—	40	0.14	1.7	—	—	—
	T9310	0.4	285	0.20	2.1	—	—	—	270	0.20	2.1	—	—	—	—	—	—	—	—	—
	T9315	0.4	255	0.20	2.1	—	—	—	240	0.20	2.1	—	—	—	—	—	—	—	—	—
	T9325	0.4	230	0.20	2.1	135	0.18	2.1	215	0.20	2.1	—	—	—	50	0.16	1.7	—	—	—
CNMG 120408E-FM	TT310	0.4	260	0.20	2.1	155	0.18	2.1	—	—	—	—	—	—	—	—	—	—	—	—
	T7325	0.8	220	0.20	2.1	170	0.18	2.1	—	—	—	—	—	—	70	0.16	1.7	—	—	—
	T7335	0.8	215	0.20	2.1	165	0.18	2.1	—	—	—	—	—	—	65	0.16	1.7	—	—	—
	T8315	0.8	205	0.20	2.1	120	0.18	2.1	190	0.20	2.1	—	—	—	50	0.16	1.7	—	—	—
	T8430	0.8	225	0.20	2.1	120	0.18	2.1	185	0.20	2.1	—	—	—	45	0.16	1.7	—	—	—
	T9310	0.8	335	0.20	2.1	—	—	—	315	0.20	2.1	—	—	—	—	—	—	—	—	—
	T9315	0.8	305	0.20	2.1	—	—	—	285	0.20	2.1	—	—	—	—	—	—	—	—	—
CNMG 120412E-FM	T9325	0.8	275	0.20	2.1	165	0.18	2.1	260	0.20	2.1	—	—	—	60	0.16	1.7	—	—	—
	TT310	0.8	310	0.20	2.1	185	0.18	2.1	—	—	—	—	—	—	—	—	—	—	—	—
	T7325	1.2	210	0.27	2.1	160	0.24	2.1	—	—	—	—	—	—	65	0.19	1.7	—	—	—
	T9315	1.2	285	0.27	2.1	—	—	—	270	0.27	2.1	—	—	—	—	—	—	—	—	—

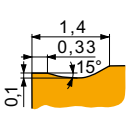

KR geometry for semi-rough to rough machining, and continuous to interrupted cuts.

CNMG 120408E-KR	T5305	0.8	255	0.35	4.0	—	—	—	240	0.35	4.0	—	—	—	50	0.18	0.7	—	—	—
	T5315	0.8	225	0.35	4.0	—	—	—	210	0.35	4.0	—	—	—	45	0.18	0.7	—	—	—



Suitability and starting values for cutting speed (vc), feed (f) and depth of cut (ap). Refer to our Machining Calculator app for further calculations.

Product	RE (mm)	P			M			K			N			S			H		
		vc (m/min)	f (mm/rev)	ap (mm)	vc (m/min)	f (mm/rev)	ap (mm)	vc (m/min)	f (mm/rev)	ap (mm)	vc (m/min)	f (mm/rev)	ap (mm)	vc (m/min)	f (mm/rev)	ap (mm)	vc (m/min)	f (mm/rev)	ap (mm)

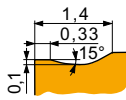

KR geometry for semi-rough to rough machining, and continuous to interrupted cuts.

CNMG 120412E-KR	T5305	1.2	255	0.40	4.0	–	–	–	240	0.40	4.0	–	–	–	–	–	–	50	0.20	1.0
	T5315	1.2	230	0.40	4.0	–	–	–	215	0.40	4.0	–	–	–	–	–	–	45	0.20	1.0

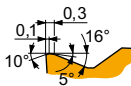
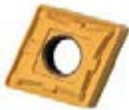







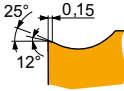

M geometry for finish to semi-rough machining, and continuous to interrupted cuts.

CNMG 090308E-M	T9315	0.8	230	0.32	1.8	–	–	–	215	0.32	1.8	–	–	–	–	–	–	45	0.16	0.7
	T9325	0.8	205	0.32	1.8	–	–	–	190	0.32	1.8	–	–	–	–	–	–	–	–	–
	T9335	0.8	180	0.32	1.8	–	–	–	–	–	–	–	–	–	–	–	–	–	–	–
CNMG 120404E-M	T5315	0.4	245	0.20	2.1	–	–	–	230	0.20	2.1	–	–	–	–	–	–	45	0.13	0.3
	T9310	0.4	260	0.20	2.1	–	–	–	245	0.20	2.1	–	–	–	–	–	–	50	0.13	0.3
	T9315	0.4	235	0.20	2.1	–	–	–	220	0.20	2.1	–	–	–	–	–	–	45	0.13	0.3
	T9325	0.4	210	0.20	2.1	–	–	–	195	0.20	2.1	–	–	–	–	–	–	–	–	–
	T9335	0.4	180	0.20	2.1	–	–	–	–	–	–	–	–	–	–	–	–	–	–	–
CNMG 120408E-M	6640	0.8	165	0.32	2.1	–	–	–	155	0.32	2.1	–	–	–	–	–	–	–	–	–
	T5305	0.8	280	0.32	2.1	–	–	–	265	0.32	2.1	–	–	–	–	–	–	55	0.16	0.7
	T5315	0.8	250	0.32	2.1	–	–	–	235	0.32	2.1	–	–	–	–	–	–	50	0.16	0.7
	T8430	0.8	170	0.32	2.1	–	–	–	135	0.32	2.1	–	–	–	–	–	–	25	0.16	0.7
	T9310	0.8	245	0.32	2.1	–	–	–	230	0.32	2.1	–	–	–	–	–	–	45	0.16	0.7
	T9315	0.8	225	0.32	2.1	–	–	–	210	0.32	2.1	–	–	–	–	–	–	45	0.16	0.7
	T9325	0.8	200	0.32	2.1	–	–	–	190	0.32	2.1	–	–	–	–	–	–	–	–	–
	T9335	0.8	180	0.32	2.1	–	–	–	–	–	–	–	–	–	–	–	–	–	–	–
CNMG 120412E-M	T5305	1.2	275	0.40	2.1	–	–	–	260	0.40	2.1	–	–	–	–	–	–	55	0.20	1.0
	T5315	1.2	245	0.40	2.1	–	–	–	230	0.40	2.1	–	–	–	–	–	–	45	0.20	1.0
	T9310	1.2	235	0.40	2.1	–	–	–	220	0.40	2.1	–	–	–	–	–	–	45	0.20	1.0
	T9315	1.2	220	0.40	2.1	–	–	–	205	0.40	2.1	–	–	–	–	–	–	40	0.20	1.0
	T9325	1.2	195	0.40	2.1	–	–	–	185	0.40	2.1	–	–	–	–	–	–	–	–	–
	T9335	1.2	170	0.40	2.1	–	–	–	–	–	–	–	–	–	–	–	–	–	–	–
CNMG 120416E-M	T9325	1.6	200	0.40	2.1	–	–	–	190	0.40	2.1	–	–	–	–	–	–	–	–	–
	T9335	1.6	175	0.40	2.1	–	–	–	–	–	–	–	–	–	–	–	–	–	–	–
CNMG 160608E-M	T9310	0.8	235	0.32	3.6	–	–	–	220	0.32	3.6	–	–	–	–	–	–	45	0.16	0.7
	T9315	0.8	215	0.32	3.6	–	–	–	200	0.32	3.6	–	–	–	–	–	–	40	0.16	0.7
	T9325	0.8	190	0.32	3.6	–	–	–	180	0.32	3.6	–	–	–	–	–	–	–	–	–
	T9335	0.8	170	0.32	3.6	–	–	–	–	–	–	–	–	–	–	–	–	–	–	–
CNMG 160612E-M	T9315	1.2	210	0.40	3.6	–	–	–	195	0.40	3.6	–	–	–	–	–	–	40	0.20	1.0
	T9325	1.2	185	0.40	3.6	–	–	–	175	0.40	3.6	–	–	–	–	–	–	–	–	–
	T9335	1.2	160	0.40	3.6	–	–	–	–	–	–	–	–	–	–	–	–	–	–	–
CNMG 160616E-M	T9325	1.6	190	0.40	3.6	–	–	–	180	0.40	3.6	–	–	–	–	–	–	–	–	–
	T9335	1.6	165	0.40	3.6	–	–	–	–	–	–	–	–	–	–	–	–	–	–	–
CNMG 190608E-M	T9315	0.8	210	0.32	4.2	–	–	–	195	0.32	4.2	–	–	–	–	–	–	40	0.16	0.7
	T9325	0.8	190	0.32	4.2	–	–	–	180	0.32	4.2	–	–	–	–	–	–	–	–	–
	T9335	0.8	165	0.32	4.2	–	–	–	–	–	–	–	–	–	–	–	–	–	–	–
CNMG 190612E-M	6640	1.2	145	0.40	4.2	–	–	–	135	0.40	4.2	–	–	–	–	–	–	–	–	–
	T9310	1.2	220	0.40	4.2	–	–	–	205	0.40	4.2	–	–	–	–	–	–	40	0.20	1.0
	T9315	1.2	205	0.40	4.2	–	–	–	190	0.40	4.2	–	–	–	–	–	–	40	0.20	1.0
	T9325	1.2	185	0.40	4.2	–	–	–	175	0.40	4.2	–	–	–	–	–	–	–	–	–
	T9335	1.2	160	0.40	4.2	–	–	–	–	–	–	–	–	–	–	–	–	–	–	–
CNMG 190616E-M	T9310	1.6	230	0.40	4.2	–	–	–	215	0.40	4.2	–	–	–	–	–	–	45	0.20	1.3
	T9315	1.6	215	0.40	4.2	–	–	–	200	0.40	4.2	–	–	–	–	–	–	40	0.20	1.3
	T9325	1.6	190	0.40	4.2	–	–	–	180	0.40	4.2	–	–	–	–	–	–	–	–	–
	T9335	1.6	165	0.40	4.2	–	–	–	–	–	–	–	–	–	–	–	–	–	–	–

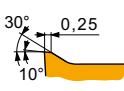

Suitability and starting values for cutting speed (vc), feed (f) and depth of cut (ap). Refer to our Machining Calculator app for further calculations.

Product	RE (mm)	P			M			K			N			S			H													
		vc	f	ap	vc	f	ap	vc	f	ap	vc	f	ap	vc	f	ap	vc	f	ap											
		(m/min)	(mm/rev)	(mm)	(m/min)	(mm/rev)	(mm)	(m/min)	(mm/rev)	(mm)	(m/min)	(mm/rev)	(mm)	(m/min)	(mm/rev)	(mm)	(m/min)	(mm/rev)	(mm)											
		25° 12°			NF geometry with highly positive design for fine-finish to medium machining, and continuous cuts.																									
					CNMG 090304E-NF	T6310	0.4	█	190	0.17	0.8	█	135	0.15	0.8	█	150	0.17	0.8	█	570	0.20	0.8	█	55	0.12	0.6	-	-	-
					T7335	0.4	█	210	0.18	0.8	█	160	0.16	0.8	-	-	-	█	65	0.16	0.6	-	-	-	-	-	-	-	-	
					T8430	0.4	█	225	0.17	0.8	█	120	0.15	0.8	█	185	0.17	0.8	█	615	0.20	0.8	█	45	0.12	0.6	-	-	-	
					T9325	0.4	█	265	0.18	0.8	█	155	0.16	0.8	█	250	0.18	0.8	-	-	-	█	55	0.16	0.6	-	-	-		
CNMG 090308E-NF	T7335	0.8	█	240	0.19	1.0	█	185	0.17	1.0	-	-	-	-	-	-	█	75	0.15	0.8	-	-	-	-	-					
	T8430	0.8	█	245	0.19	1.0	█	135	0.17	1.0	█	200	0.19	1.0	█	675	0.23	1.0	█	50	0.15	0.8	-	-	-					
	T9325	0.8	█	300	0.19	1.0	█	180	0.17	1.0	█	285	0.19	1.0	-	-	-	█	65	0.15	0.8	-	-	-						
CNMG 120404E-NF	HF7	0.4	-	-	-	█	95	0.15	1.7	█	155	0.17	1.7	█	495	0.20	1.7	-	-	-	-	-	-	-	-					
	T6310	0.4	█	180	0.17	1.7	█	125	0.15	1.7	█	145	0.17	1.7	█	540	0.20	1.7	█	50	0.14	1.4	-	-	-					
	T7325	0.4	█	200	0.18	1.7	█	155	0.16	1.7	-	-	-	-	-	-	-	█	65	0.16	1.4	-	-	-						
	T7335	0.4	█	195	0.18	1.7	█	150	0.16	1.7	-	-	-	-	-	-	-	-	█	60	0.16	1.4	-	-	-					
	T8315	0.4	█	185	0.17	1.7	█	110	0.15	1.7	█	175	0.17	1.7	█	555	0.20	1.7	█	45	0.14	1.4	-	-	-					
	T8430	0.4	█	200	0.17	1.7	█	110	0.15	1.7	█	165	0.17	1.7	█	555	0.20	1.7	█	40	0.14	1.4	-	-	-					
	T9315	0.4	█	285	0.17	1.7	-	-	-	-	█	270	0.17	1.7	-	-	-	-	-	-	-	-	-	-	-					
	T9325	0.4	█	250	0.18	1.7	█	150	0.16	1.7	█	235	0.18	1.7	-	-	-	█	55	0.16	1.4	-	-	-						
CNMG 120408E-NF	HF7	0.8	-	-	-	█	110	0.17	1.7	█	180	0.19	1.7	█	570	0.23	1.7	-	-	-	-	-	-	-	-					
	T6310	0.8	█	200	0.19	1.7	█	140	0.17	1.7	█	160	0.19	1.7	█	600	0.23	1.7	█	60	0.15	1.4	-	-	-					
	T7325	0.8	█	235	0.19	1.7	█	180	0.17	1.7	-	-	-	-	-	-	-	-	█	75	0.15	1.4	-	-	-					
	T7335	0.8	█	225	0.19	1.7	█	175	0.17	1.7	-	-	-	-	-	-	-	-	-	█	70	0.15	1.4	-	-	-				
	T8315	0.8	█	215	0.19	1.7	█	125	0.17	1.7	█	200	0.19	1.7	█	645	0.23	1.7	█	50	0.15	1.4	-	-	-					
	T8430	0.8	█	235	0.19	1.7	█	125	0.17	1.7	█	190	0.19	1.7	█	645	0.23	1.7	█	50	0.15	1.4	-	-	-					
	T9315	0.8	█	320	0.19	1.7	-	-	-	-	█	300	0.19	1.7	-	-	-	-	-	-	-	-	-	-	-					
	T9325	0.8	█	285	0.19	1.7	█	170	0.17	1.7	█	270	0.19	1.7	-	-	-	█	60	0.15	1.4	-	-	-						
CNMG 120412E-NF	T6310	1.2	█	185	0.30	2.1	█	130	0.27	2.1	█	145	0.30	2.1	█	555	0.36	2.1	█	55	0.21	1.7	-	-	-					
	T7325	1.2	█	205	0.30	2.1	█	155	0.27	2.1	-	-	-	-	-	-	-	-	█	65	0.21	1.7	-	-	-					
	T7335	1.2	█	200	0.30	2.1	█	155	0.27	2.1	-	-	-	-	-	-	-	-	-	█	65	0.21	1.7	-	-	-				
	T8430	1.2	█	200	0.30	2.1	█	110	0.27	2.1	█	165	0.30	2.1	█	555	0.36	2.1	█	40	0.21	1.7	-	-	-					
	T9315	1.2	█	275	0.30	2.1	-	-	-	-	█	260	0.30	2.1	-	-	-	-	-	-	-	-	-	-	-					
		30° 10°				NM geometry with highly positive design for fine-finish, medium and rough machining, with continuous cuts.																								
						CNMG 120404E-NM	T7325	0.4	█	195	0.20	2.1	█	150	0.18	2.1	-	-	-	-	-	-	█	60	0.16	1.7	-	-	-	
						T7335	0.4	█	190	0.20	2.1	█	145	0.18	2.1	-	-	-	-	-	-	-	-	█	60	0.16	1.7	-	-	-
						T8315	0.4	█	180	0.20	2.1	█	105	0.18	2.1	-	-	-	█	540	0.24	2.1	█	45	0.16	1.7	-	-	-	
						T8430	0.4	█	195	0.20	2.1	█	105	0.18	2.1	-	-	-	█	540	0.24	2.1	█	40	0.16	1.7	-	-	-	
CNMG 120408E-NM	T9315	0.4	█	270	0.20	2.1	-	-	-	-	-	-	-	-	-	-	-	-	-	-	-	-	-	-						
	T9325	0.4	█	240	0.20	2.1	█	140	0.18	2.1	-	-	-	-	-	-	-	-	█	50	0.16	1.7	-	-	-					
	T7325	0.8	█	215	0.25	2.1	█	165	0.23	2.1	-	-	-	-	-	-	-	-	█	65	0.20	1.7	-	-	-					
	T7335	0.8	█	210	0.25	2.1	█	160	0.23	2.1	-	-	-	-	-	-	-	-	-	█	65	0.20	1.7	-	-	-				
	T8315	0.8	█	205	0.25	2.1	█	120	0.23	2.1	-	-	-	█	615	0.30	2.1	█	50	0.20	1.7	-	-	-						
	T8430	0.8	█	210	0.25	2.1	█	115	0.23	2.1	-	-	-	█	585	0.30	2.1	█	45	0.20	1.7	-	-	-						
CNMG 120412E-NM	T9315	0.8	█	290	0.25	2.1	-	-	-	-	-	-	-	-	-	-	-	-	-	-	-	-	-	-						
	T9325	0.8	█	260	0.25	2.1	█	155	0.23	2.1	-	-	-	-	-	-	-	-	█	55	0.20	1.7	-	-	-					
	T7325	1.2	█	215	0.30	2.1	█	165	0.27	2.1	-	-	-	-	-	-	-	-	█	65	0.24	1.7	-	-	-					
	T7335	1.2	█	210	0.30	2.1	█	160	0.27	2.1	-	-	-	-	-	-	-	-	-	█	65	0.24	1.7	-	-	-				
	T8315	1.2	█	205	0.30	2.1	█	120	0.27	2.1	-	-	-	█	615	0.36	2.1	█	50	0.24	1.7	-	-	-						
CNMG 160608E-NM	T8430	1.2	█	210	0.30	2.1	█	115	0.27	2.1	-	-	-	█	585	0.36	2.1	█	45	0.24	1.7	-	-	-						
	T9325	1.2	█	255	0.30	2.1	█	150	0.27	2.1	-	-	-	-	-	-	-	-	█	55	0.24	1.7	-	-	-					
	T7325	0.8	█	195	0.30	3.6	█	150	0.27	3.6	-	-	-	-	-	-	-	-	█	60	0.27	2.9	-	-	-					
	T7335	0.8	█	190	0.30	3.6	█	145	0.27	3.6	-	-	-	-	-	-	-	-	-	█	60	0.27	2.9	-	-	-				
	T8430	0.8	█	185	0.30	3.6	█	100	0.27	3.6	-	-	-	█	510	0.36	3.6	█	40	0.27	2.9	-	-	-						
T9325	0.8	█	225	0.30	3.6	█	135	0.27	3.6	-	-	-	-	-	-	-	-	█	50	0.27	2.9	-	-	-						



Suitability and starting values for cutting speed (vc), feed (f) and depth of cut (ap). Refer to our Machining Calculator app for further calculations.

Product	RE (mm)	P			M			K			N			S			H		
		vc (m/min)	f (mm/rev)	ap (mm)	vc (m/min)	f (mm/rev)	ap (mm)	vc (m/min)	f (mm/rev)	ap (mm)	vc (m/min)	f (mm/rev)	ap (mm)	vc (m/min)	f (mm/rev)	ap (mm)	vc (m/min)	f (mm/rev)	ap (mm)

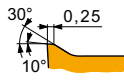

NM geometry with highly positive design for fine-finish, medium and rough machining, with continuous cuts.

CNMG 160612E-NM	T7325	1.2	205	0.30	3.6	155	0.27	3.6	-	-	-	-	-	-	65	0.27	2.9	-	-	-
	T7335	1.2	200	0.30	3.6	155	0.27	3.6	-	-	-	-	-	-	65	0.27	2.9	-	-	-
	T8315	1.2	195	0.30	3.6	115	0.27	3.6	-	-	-	585	0.36	3.6	45	0.27	2.9	-	-	-
	T9325	1.2	240	0.30	3.6	140	0.27	3.6	-	-	-	-	-	-	50	0.27	2.9	-	-	-
CNMG 190612E-NM	T7325	1.2	195	0.35	4.2	150	0.32	4.2	-	-	-	-	-	-	60	0.32	3.4	-	-	-
	T7335	1.2	180	0.35	4.2	140	0.32	4.2	-	-	-	-	-	-	55	0.32	3.4	-	-	-
	T8315	1.2	180	0.35	4.2	105	0.32	4.2	-	-	-	540	0.42	4.2	45	0.32	3.4	-	-	-
	T8430	1.2	180	0.35	4.2	95	0.32	4.2	-	-	-	495	0.42	4.2	35	0.32	3.4	-	-	-
	T9325	1.2	220	0.35	4.2	130	0.32	4.2	-	-	-	-	-	-	45	0.32	3.4	-	-	-

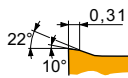

NMR geometry with positive design for medium to rough machining, and continuous cuts.

CNMG 090308E-NMR	T7325	0.8	175	0.35	1.6	135	0.32	1.6	-	-	-	-	-	-	55	0.25	1.3	-	-	-
	T7335	0.8	170	0.35	1.6	130	0.32	1.6	-	-	-	-	-	-	55	0.25	1.3	-	-	-
CNMG 120404E-NMR	T7325	0.4	155	0.25	2.7	120	0.23	2.7	-	-	-	-	-	-	50	0.20	2.2	-	-	-
	T7335	0.4	155	0.25	2.0	120	0.23	2.0	-	-	-	-	-	-	50	0.20	1.6	-	-	-
	T8430	0.4	150	0.25	2.7	80	0.23	2.7	-	-	-	-	-	-	30	0.20	2.2	-	-	-
	T9315	0.4	215	0.25	2.0	-	-	-	-	-	-	-	-	-	-	-	-	-	-	-
	T9325	0.4	190	0.25	2.0	110	0.23	2.0	-	-	-	-	-	-	40	0.20	1.6	-	-	-
CNMG 120408E-NMR	T6310	0.8	150	0.35	2.7	105	0.32	2.7	-	-	-	-	-	-	45	0.25	2.2	-	-	-
	T7325	0.8	170	0.35	2.7	130	0.32	2.7	-	-	-	-	-	-	55	0.25	2.2	-	-	-
	T7335	0.8	160	0.35	2.7	120	0.32	2.7	-	-	-	-	-	-	50	0.25	2.2	-	-	-
	T8430	0.8	155	0.35	2.7	85	0.32	2.7	-	-	-	-	-	-	30	0.25	2.2	-	-	-
	T9315	0.8	210	0.35	2.7	-	-	-	-	-	-	-	-	-	-	-	-	-	-	-
	T9325	0.8	190	0.35	2.7	110	0.32	2.7	-	-	-	-	-	-	40	0.25	2.2	-	-	-
CNMG 120412E-NMR	T6310	1.2	150	0.40	2.7	105	0.36	2.7	-	-	-	-	-	-	45	0.28	2.2	-	-	-
	T7325	1.2	170	0.40	2.7	130	0.36	2.7	-	-	-	-	-	-	55	0.28	2.2	-	-	-
	T7335	1.2	160	0.40	2.7	120	0.36	2.7	-	-	-	-	-	-	50	0.28	2.2	-	-	-
	T8430	1.2	155	0.40	2.7	85	0.36	2.7	-	-	-	-	-	-	30	0.28	2.2	-	-	-
	T9315	1.2	215	0.40	2.7	-	-	-	-	-	-	-	-	-	-	-	-	-	-	-
CNMG 120416E-NMR	T7325	1.6	170	0.45	2.7	130	0.41	2.7	-	-	-	-	-	-	55	0.32	2.2	-	-	-
	T7335	1.6	160	0.45	2.7	120	0.41	2.7	-	-	-	-	-	-	50	0.32	2.2	-	-	-
CNMG 160608E-NMR	T7325	0.8	160	0.35	4.0	120	0.32	4.0	-	-	-	-	-	-	50	0.25	3.2	-	-	-
	T7335	0.8	150	0.35	4.0	115	0.32	4.0	-	-	-	-	-	-	45	0.25	3.2	-	-	-
	T9315	0.8	205	0.35	4.0	-	-	-	-	-	-	-	-	-	-	-	-	-	-	-
	T9325	0.8	185	0.35	4.0	110	0.32	4.0	-	-	-	-	-	-	40	0.25	3.2	-	-	-
CNMG 160612E-NMR	T7325	1.2	165	0.40	4.0	125	0.36	4.0	-	-	-	-	-	-	50	0.28	3.2	-	-	-
	T7335	1.2	155	0.40	4.0	120	0.36	4.0	-	-	-	-	-	-	50	0.28	3.2	-	-	-
	T8430	1.2	150	0.40	4.0	80	0.36	4.0	-	-	-	-	-	-	30	0.28	3.2	-	-	-
	T9315	1.2	205	0.40	4.0	-	-	-	-	-	-	-	-	-	-	-	-	-	-	-
	T9325	1.2	185	0.40	4.0	110	0.36	4.0	-	-	-	-	-	-	40	0.28	3.2	-	-	-
CNMG 160616E-NMR	T7325	1.6	165	0.45	4.0	125	0.41	4.0	-	-	-	-	-	-	50	0.32	3.2	-	-	-
	T7335	1.6	155	0.45	4.0	120	0.41	4.0	-	-	-	-	-	-	50	0.32	3.2	-	-	-
	T8430	1.6	150	0.45	4.0	80	0.41	4.0	-	-	-	-	-	-	30	0.32	3.2	-	-	-
	T9315	1.6	200	0.45	4.0	-	-	-	-	-	-	-	-	-	-	-	-	-	-	-
	T9325	1.6	180	0.45	4.0	105	0.41	4.0	-	-	-	-	-	-	40	0.32	3.2	-	-	-
CNMG 190608E-NMR	T6310	0.8	140	0.35	5.2	100	0.32	5.2	-	-	-	-	-	-	40	0.25	4.2	-	-	-
	T7325	0.8	155	0.35	5.2	120	0.32	5.2	-	-	-	-	-	-	50	0.25	4.2	-	-	-
	T7335	0.8	150	0.35	5.2	115	0.32	5.2	-	-	-	-	-	-	45	0.25	4.2	-	-	-
	T9315	0.8	195	0.35	5.2	-	-	-	-	-	-	-	-	-	-	-	-	-	-	-
	T9325	0.8	180	0.35	5.2	105	0.32	5.2	-	-	-	-	-	-	40	0.25	4.2	-	-	-



Suitability and starting values for cutting speed (vc), feed (f) and depth of cut (ap). Refer to our Machining Calculator app for further calculations.

Product	RE (mm)	P			M			K			N			S			H		
		vc (m/min)	f (mm/rev)	ap (mm)	vc (m/min)	f (mm/rev)	ap (mm)	vc (m/min)	f (mm/rev)	ap (mm)	vc (m/min)	f (mm/rev)	ap (mm)	vc (m/min)	f (mm/rev)	ap (mm)	vc (m/min)	f (mm/rev)	ap (mm)

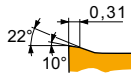

NMR geometry with positive design for medium to rough machining, and continuous cuts.

CNMG 190612E-NMR	T6310	1.2	140	0.40	5.2	100	0.36	5.2	–	–	–	–	–	–	40	0.28	4.2	–	–	–
	T7325	1.2	160	0.40	5.2	120	0.36	5.2	–	–	–	–	–	–	50	0.28	4.2	–	–	–
	T7335	1.2	150	0.40	5.2	115	0.36	5.2	–	–	–	–	–	–	45	0.28	4.2	–	–	–
	T8430	1.2	145	0.40	5.2	80	0.36	5.2	–	–	–	–	–	–	30	0.28	4.2	–	–	–
	T9325	1.2	180	0.40	5.2	105	0.36	5.2	–	–	–	–	–	–	40	0.28	4.2	–	–	–
CNMG 190616E-NMR	T7325	1.6	160	0.45	5.2	120	0.41	5.2	–	–	–	–	–	–	50	0.32	4.2	–	–	–
	T7335	1.6	150	0.45	5.2	115	0.41	5.2	–	–	–	–	–	–	45	0.32	4.2	–	–	–
	T9315	1.6	195	0.45	5.2	–	–	–	–	–	–	–	–	–	–	–	–	–	–	–
	T9325	1.6	175	0.45	5.2	105	0.41	5.2	–	–	–	–	–	–	35	0.32	4.2	–	–	–

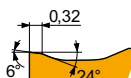

NRM geometry with positive design for semi-rough to rough machining, and continuous to moderate interrupted cuts.

CNMG 120408-NRM	T7325	0.8	160	0.35	4.0	120	0.32	4.0	–	–	–	–	–	–	50	0.28	3.2	–	–	–
	T9315	0.8	205	0.35	4.0	–	–	–	–	–	–	–	–	–	–	–	–	–	–	–
CNMG 120412-NRM	T7325	1.2	165	0.40	4.0	125	0.36	4.0	–	–	–	–	–	–	50	0.28	3.2	–	–	–
	T9315	1.2	205	0.40	4.0	–	–	–	–	–	–	–	–	–	–	–	–	–	–	–
CNMG 160608-NRM	T7325	0.8	155	0.35	6.0	120	0.32	6.0	–	–	–	–	–	–	50	0.28	4.8	–	–	–
	T9315	0.8	195	0.35	6.0	–	–	–	–	–	–	–	–	–	–	–	–	–	–	–
CNMG 160612-NRM	T7325	1.2	155	0.40	6.0	120	0.36	6.0	–	–	–	–	–	–	50	0.32	4.8	–	–	–
	T7335	1.2	150	0.40	6.0	115	0.36	6.0	–	–	–	–	–	–	45	0.32	4.8	–	–	–
	T9315	1.2	200	0.40	6.0	–	–	–	–	–	–	–	–	–	–	–	–	–	–	–
CNMG 160616-NRM	T7325	1.6	155	0.45	6.0	120	0.41	6.0	–	–	–	–	–	–	50	0.36	4.8	–	–	–
	T7335	1.6	150	0.45	6.0	115	0.41	6.0	–	–	–	–	–	–	45	0.36	4.8	–	–	–
	T9315	1.6	195	0.45	6.0	–	–	–	–	–	–	–	–	–	–	–	–	–	–	–
CNMG 190612-NRM	T7325	1.2	155	0.40	8.0	120	0.36	8.0	–	–	–	–	–	–	50	0.32	6.4	–	–	–
	T9315	1.2	190	0.40	8.0	–	–	–	–	–	–	–	–	–	–	–	–	–	–	–
CNMG 190616-NRM	T7325	1.6	150	0.45	8.0	115	0.41	8.0	–	–	–	–	–	–	45	0.36	6.4	–	–	–
	T7335	1.6	145	0.45	8.0	110	0.41	8.0	–	–	–	–	–	–	45	0.36	6.4	–	–	–
	T9315	1.6	190	0.45	8.0	–	–	–	–	–	–	–	–	–	–	–	–	–	–	–
CNMG 250924-NRM	T7325	2.4	95	0.70	10.0	70	0.63	10.0	–	–	–	–	–	–	30	0.49	8.0	–	–	–
	T7335	2.4	90	0.70	10.0	70	0.63	10.0	–	–	–	–	–	–	25	0.49	8.0	–	–	–

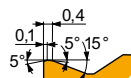

R geometry for semi-rough to rough machining, and continuous to interrupted cuts.

CNMG 120408E-R	6640	0.8	140	0.40	4.0	–	–	–	130	0.40	4.0	–	–	–	–	–	–	–	–	–
	T5305	0.8	240	0.40	4.0	–	–	–	225	0.40	4.0	–	–	–	–	–	–	45	0.20	0.7
	T5315	0.8	215	0.40	4.0	–	–	–	200	0.40	4.0	–	–	–	–	–	–	40	0.20	0.7
	T9310	0.8	205	0.40	4.0	–	–	–	190	0.40	4.0	–	–	–	–	–	–	40	0.20	0.7
	T9315	0.8	190	0.40	4.0	–	–	–	180	0.40	4.0	–	–	–	–	–	–	35	0.20	0.7
	T9325	0.8	175	0.40	4.0	–	–	–	165	0.40	4.0	–	–	–	–	–	–	–	–	–
	T9335	0.8	150	0.40	4.0	–	–	–	–	–	–	–	–	–	–	–	–	–	–	–
	CNMG 120412E-R	T9315	1.2	195	0.45	4.0	–	–	–	185	0.45	4.0	–	–	–	–	–	–	35	0.23
T9325		1.2	175	0.45	4.0	–	–	–	165	0.45	4.0	–	–	–	–	–	–	–	–	–
T9335		1.2	155	0.45	4.0	–	–	–	–	–	–	–	–	–	–	–	–	–	–	–
CNMG 120416E-R	T5315	1.6	225	0.50	4.0	–	–	–	210	0.50	4.0	–	–	–	–	–	–	45	0.25	1.3
	T9335	1.6	150	0.50	4.0	–	–	–	–	–	–	–	–	–	–	–	–	–	–	–
CNMG 160608E-R	T5315	0.8	210	0.40	5.5	–	–	–	195	0.40	5.5	–	–	–	–	–	–	40	0.20	0.7
CNMG 160612E-R	T5315	1.2	215	0.45	5.5	–	–	–	200	0.45	5.5	–	–	–	–	–	–	40	0.23	1.0
	T7335	1.2	145	0.45	5.5	–	–	–	–	–	–	–	–	–	–	–	–	–	–	–
	T9310	1.2	205	0.45	5.5	–	–	–	190	0.45	5.5	–	–	–	–	–	–	40	0.23	1.0
	T9315	1.2	190	0.45	5.5	–	–	–	180	0.45	5.5	–	–	–	–	–	–	35	0.23	1.0
	T9325	1.2	170	0.45	5.5	–	–	–	160	0.45	5.5	–	–	–	–	–	–	–	–	–



Suitability and starting values for cutting speed (vc), feed (f) and depth of cut (ap). Refer to our Machining Calculator app for further calculations.

Product	RE (mm)	P			M			K			N			S			H		
		vc (m/min)	f (mm/rev)	ap (mm)	vc (m/min)	f (mm/rev)	ap (mm)	vc (m/min)	f (mm/rev)	ap (mm)	vc (m/min)	f (mm/rev)	ap (mm)	vc (m/min)	f (mm/rev)	ap (mm)	vc (m/min)	f (mm/rev)	ap (mm)

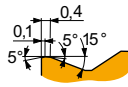

R geometry for semi-rough to rough machining, and continuous to interrupted cuts.

CNMG 190612E-R	6640	1.2	■	135	0.45	7.0	-	-	-	■	125	0.45	7.0	-	-	-	-	-	-			
	T5315	1.2	▣	210	0.45	7.0	-	-	-	■	195	0.45	7.0	-	-	-	-	▣	40	0.23	1.0	
	T9315	1.2	■	185	0.45	7.0	-	-	-	▣	175	0.45	7.0	-	-	-	-	-	▣	35	0.23	1.0
	T9325	1.2	■	165	0.45	7.0	-	-	-	▣	155	0.45	7.0	-	-	-	-	-	-	-	-	-
	T9335	1.2	■	145	0.45	7.0	-	-	-	-	-	-	-	-	-	-	-	-	-	-	-	-
CNMG 190616E-R	6640	1.6	■	130	0.50	7.0	-	-	-	■	120	0.50	7.0	-	-	-	-	-	-	-	-	
	T5315	1.6	▣	210	0.50	7.0	-	-	-	■	195	0.50	7.0	-	-	-	-	-	▣	40	0.25	1.3
	T9310	1.6	■	195	0.50	7.0	-	-	-	▣	185	0.50	7.0	-	-	-	-	-	▣	35	0.25	1.3
	T9315	1.6	■	180	0.50	7.0	-	-	-	▣	170	0.50	7.0	-	-	-	-	-	▣	35	0.25	1.3
	T9325	1.6	■	165	0.50	7.0	-	-	-	▣	155	0.50	7.0	-	-	-	-	-	-	-	-	-
	T9335	1.6	■	145	0.50	7.0	-	-	-	-	-	-	-	-	-	-	-	-	-	-	-	-

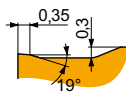





RM geometry for semi-rough to rough machining, and continuous to interrupted cuts.

CNMG 120408E-RM	T5305	0.8	▣	275	0.40	4.0	-	-	-	▣	260	0.40	4.0	-	-	-	-	-	-	-		
	T5315	0.8	▣	250	0.40	4.0	-	-	-	▣	235	0.40	4.0	-	-	-	-	-	-	-	-	
	T6310	0.8	■	155	0.40	4.0	▣	110	0.36	4.0	▣	125	0.40	4.0	-	-	-	-	-	-	-	
	T7325	0.8	▣	180	0.40	4.0	▣	140	0.36	4.0	-	-	-	-	-	-	-	-	-	-	-	
	T7335	0.8	▣	165	0.40	4.0	▣	125	0.36	4.0	-	-	-	-	-	-	-	-	-	-	-	
	T8315	0.8	▣	165	0.40	4.0	▣	95	0.36	4.0	▣	155	0.40	4.0	-	-	-	-	-	-	-	-
	T8430	0.8	■	165	0.40	4.0	▣	90	0.36	4.0	▣	135	0.40	4.0	-	-	-	-	-	-	-	-
	T9310	0.8	■	240	0.40	4.0	-	-	-	▣	225	0.40	4.0	-	-	-	-	-	-	-	-	-
	T9315	0.8	■	220	0.40	4.0	-	-	-	▣	205	0.40	4.0	-	-	-	-	-	-	-	-	-
	T9325	0.8	■	200	0.40	4.0	▣	120	0.36	4.0	▣	190	0.40	4.0	-	-	-	-	-	-	-	-
	T9335	0.8	■	170	0.40	4.0	▣	100	0.36	4.0	-	-	-	-	-	-	-	-	-	-	-	
CNMG 120412E-RM	T5305	1.2	▣	280	0.45	4.0	-	-	-	▣	265	0.45	4.0	-	-	-	-	-	-	-	-	
	T5315	1.2	▣	250	0.45	4.0	-	-	-	▣	235	0.45	4.0	-	-	-	-	-	-	-	-	
	T6310	1.2	■	160	0.45	4.0	▣	115	0.41	4.0	▣	125	0.45	4.0	-	-	-	-	-	-	-	
	T7325	1.2	▣	180	0.45	4.0	▣	140	0.41	4.0	-	-	-	-	-	-	-	-	-	-	-	
	T7335	1.2	▣	170	0.45	4.0	▣	130	0.41	4.0	-	-	-	-	-	-	-	-	-	-	-	
	T8315	1.2	▣	170	0.45	4.0	▣	100	0.41	4.0	▣	160	0.45	4.0	-	-	-	-	-	-	-	-
	T8430	1.2	■	170	0.45	4.0	▣	90	0.41	4.0	▣	135	0.45	4.0	-	-	-	-	-	-	-	-
	T9310	1.2	■	240	0.45	4.0	-	-	-	▣	225	0.45	4.0	-	-	-	-	-	-	-	-	-
	T9315	1.2	■	220	0.45	4.0	-	-	-	▣	205	0.45	4.0	-	-	-	-	-	-	-	-	-
	T9325	1.2	■	200	0.45	4.0	▣	120	0.41	4.0	▣	190	0.45	4.0	-	-	-	-	-	-	-	-
	T9335	1.2	■	175	0.45	4.0	▣	105	0.41	4.0	-	-	-	-	-	-	-	-	-	-	-	
CNMG 120416E-RM	T5315	1.6	▣	255	0.50	4.0	-	-	-	▣	240	0.50	4.0	-	-	-	-	-	-	-	-	
	T7335	1.6	▣	175	0.50	4.0	▣	135	0.45	4.0	-	-	-	-	-	-	-	-	-	-	-	
	T8430	1.6	■	170	0.50	4.0	▣	90	0.45	4.0	▣	135	0.50	4.0	-	-	-	-	-	-	-	
	T9310	1.6	■	240	0.50	4.0	-	-	-	▣	225	0.50	4.0	-	-	-	-	-	-	-	-	
	T9315	1.6	■	220	0.50	4.0	-	-	-	▣	205	0.50	4.0	-	-	-	-	-	-	-	-	
	T9325	1.6	■	205	0.50	4.0	▣	120	0.45	4.0	▣	190	0.50	4.0	-	-	-	-	-	-	-	
CNMG 160608E-RM	T5305	0.8	▣	265	0.40	6.0	-	-	-	▣	250	0.40	6.0	-	-	-	-	-	-	-	-	
	T5315	0.8	▣	240	0.40	6.0	-	-	-	▣	225	0.40	6.0	-	-	-	-	-	-	-	-	
	T8430	0.8	■	155	0.40	6.0	▣	85	0.36	6.0	▣	130	0.40	6.0	-	-	-	-	-	-	-	
	T9315	0.8	■	215	0.40	6.0	-	-	-	▣	200	0.40	6.0	-	-	-	-	-	-	-	-	
	T9325	0.8	■	190	0.40	6.0	▣	110	0.36	6.0	▣	180	0.40	6.0	-	-	-	-	-	-	-	
	T9335	0.8	■	165	0.40	6.0	▣	95	0.36	6.0	-	-	-	-	-	-	-	-	-	-	-	

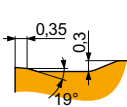

Suitability and starting values for cutting speed (vc), feed (f) and depth of cut (ap). Refer to our Machining Calculator app for further calculations.

Product	RE (mm)	P			M			K			N			S			H		
		vc	f	ap	vc	f	ap	vc	f	ap	vc	f	ap	vc	f	ap	vc	f	ap
		(m/min)	(mm/rev)	(mm)	(m/min)	(mm/rev)	(mm)	(m/min)	(mm/rev)	(mm)	(m/min)	(mm/rev)	(mm)	(m/min)	(mm/rev)	(mm)	(m/min)	(mm/rev)	(mm)
     RM geometry for semi-rough to rough machining, and continuous to interrupted cuts.	CNMG 160612E-RM	T5305	1.2	270	0.45	6.0	—	—	—	255	0.45	6.0	—	—	—	—	—	—	—
	T5315	1.2	245	0.45	6.0	—	—	—	230	0.45	6.0	—	—	—	—	—	—	—	—
	T6310	1.2	155	0.45	6.0	110	0.41	6.0	125	0.45	6.0	—	—	—	—	—	—	—	—
	T7325	1.2	170	0.45	6.0	130	0.41	6.0	—	—	—	—	—	—	—	—	—	—	—
	T7335	1.2	165	0.45	6.0	125	0.41	6.0	—	—	—	—	—	—	—	—	—	—	—
	T8430	1.2	155	0.45	6.0	85	0.41	6.0	130	0.45	6.0	—	—	—	—	—	—	—	—
	T9310	1.2	230	0.45	6.0	—	—	—	215	0.45	6.0	—	—	—	—	—	—	—	—
	T9315	1.2	215	0.45	6.0	—	—	—	200	0.45	6.0	—	—	—	—	—	—	—	—
	T9325	1.2	195	0.45	6.0	115	0.41	6.0	185	0.45	6.0	—	—	—	—	—	—	—	—
	T9335	1.2	165	0.45	6.0	95	0.41	6.0	—	—	—	—	—	—	—	—	—	—	—
CNMG 160616E-RM	T5305	1.6	270	0.50	6.0	—	—	—	255	0.50	6.0	—	—	—	—	—	—	—	—
T5315	1.6	245	0.50	6.0	—	—	—	230	0.50	6.0	—	—	—	—	—	—	—	—	
T7325	1.6	175	0.50	6.0	135	0.45	6.0	—	—	—	—	—	—	—	—	—	—	—	
T7335	1.6	165	0.50	6.0	125	0.45	6.0	—	—	—	—	—	—	—	—	—	—	—	
T9310	1.6	225	0.50	6.0	—	—	—	210	0.50	6.0	—	—	—	—	—	—	—	—	
T9315	1.6	215	0.50	6.0	—	—	—	200	0.50	6.0	—	—	—	—	—	—	—	—	
T9325	1.6	190	0.50	6.0	110	0.45	6.0	180	0.50	6.0	—	—	—	—	—	—	—	—	
T9335	1.6	165	0.50	6.0	95	0.45	6.0	—	—	—	—	—	—	—	—	—	—	—	
CNMG 190608E-RM	T5305	0.8	260	0.40	7.5	—	—	—	245	0.40	7.5	—	—	—	—	—	—	—	—
T5315	0.8	230	0.40	7.5	—	—	—	215	0.40	7.5	—	—	—	—	—	—	—	—	
T7335	0.8	155	0.40	7.5	120	0.36	7.5	—	—	—	—	—	—	—	—	—	—	—	
T9315	0.8	210	0.40	7.5	—	—	—	195	0.40	7.5	—	—	—	—	—	—	—	—	
T9325	0.8	190	0.40	7.5	110	0.36	7.5	180	0.40	7.5	—	—	—	—	—	—	—	—	
T9335	0.8	160	0.40	7.5	95	0.36	7.5	—	—	—	—	—	—	—	—	—	—	—	
CNMG 190612E-RM	T5305	1.2	260	0.45	7.5	—	—	—	245	0.45	7.5	—	—	—	—	—	—	—	—
T5315	1.2	240	0.45	7.5	—	—	—	225	0.45	7.5	—	—	—	—	—	—	—	—	
T6310	1.2	155	0.45	7.5	110	0.41	7.5	125	0.45	7.5	—	—	—	—	—	—	—	—	
T7325	1.2	170	0.45	7.5	130	0.41	7.5	—	—	—	—	—	—	—	—	—	—	—	
T7335	1.2	160	0.45	7.5	120	0.41	7.5	—	—	—	—	—	—	—	—	—	—	—	
T8430	1.2	150	0.45	7.5	80	0.41	7.5	125	0.45	7.5	—	—	—	—	—	—	—	—	
T9310	1.2	220	0.45	7.5	—	—	—	205	0.45	7.5	—	—	—	—	—	—	—	—	
T9315	1.2	210	0.45	7.5	—	—	—	195	0.45	7.5	—	—	—	—	—	—	—	—	
T9325	1.2	185	0.45	7.5	110	0.41	7.5	175	0.45	7.5	—	—	—	—	—	—	—	—	
T9335	1.2	165	0.45	7.5	95	0.41	7.5	—	—	—	—	—	—	—	—	—	—	—	
CNMG 190616E-RM	T5305	1.6	265	0.50	7.5	—	—	—	250	0.50	7.5	—	—	—	—	—	—	—	—
T5315	1.6	240	0.50	7.5	—	—	—	225	0.50	7.5	—	—	—	—	—	—	—	—	
T6310	1.6	155	0.50	7.5	110	0.45	7.5	125	0.50	7.5	—	—	—	—	—	—	—	—	
T7325	1.6	175	0.50	7.5	135	0.45	7.5	—	—	—	—	—	—	—	—	—	—	—	
T7335	1.6	160	0.50	7.5	120	0.45	7.5	—	—	—	—	—	—	—	—	—	—	—	
T9310	1.6	225	0.50	7.5	—	—	—	210	0.50	7.5	—	—	—	—	—	—	—	—	
T9315	1.6	210	0.50	7.5	—	—	—	195	0.50	7.5	—	—	—	—	—	—	—	—	
T9325	1.6	190	0.50	7.5	110	0.45	7.5	180	0.50	7.5	—	—	—	—	—	—	—	—	
T9335	1.6	160	0.50	7.5	95	0.45	7.5	—	—	—	—	—	—	—	—	—	—	—	
CNMG 250924E-RM	T7325	2.4	105	0.80	12.0	80	0.72	12.0	—	—	—	—	—	—	—	—	—	—	
T7335	2.4	100	0.80	12.0	75	0.72	12.0	—	—	—	—	—	—	—	—	—	—	—	
T9226	2.4	90	0.80	12.0	50	0.72	12.0	85	0.80	12.0	—	—	—	—	—	—	—	—	
T9315	2.4	120	0.80	12.0	—	—	—	110	0.80	12.0	—	—	—	—	—	—	—	—	
T9325	2.4	105	0.80	12.0	60	0.72	12.0	95	0.80	12.0	—	—	—	—	—	—	—	—	
T9335	2.4	85	0.80	12.0	50	0.72	12.0	—	—	—	—	—	—	—	—	—	—	—	



Suitability and starting values for cutting speed (vc), feed (f) and depth of cut (ap). Refer to our Machining Calculator app for further calculations.

Product	RE (mm)	P			M			K			N			S			H		
		vc (m/min)	f (mm/rev)	ap (mm)	vc (m/min)	f (mm/rev)	ap (mm)	vc (m/min)	f (mm/rev)	ap (mm)	vc (m/min)	f (mm/rev)	ap (mm)	vc (m/min)	f (mm/rev)	ap (mm)	vc (m/min)	f (mm/rev)	ap (mm)

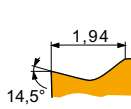

SF geometry with positive design for fine-finish machining of thin walls and continuous cuts.

CNMG 120404E-SF	H07	0.4	–	–	–	90	0.14	1.0	145	0.15	1.0	470	0.18	1.0	45	0.12	0.8	–	–	–
	T6310	0.4	180	0.15	1.0	125	0.14	1.0	145	0.15	1.0	540	0.18	1.0	50	0.12	0.8	35	0.11	0.3
	T7325	0.4	205	0.17	1.0	155	0.15	1.0	–	–	–	–	–	–	65	0.15	0.8	–	–	–
	T8315	0.4	195	0.15	1.0	115	0.14	1.0	185	0.15	1.0	585	0.18	1.0	45	0.12	0.8	35	0.11	0.3
	T8430	0.4	220	0.15	1.0	120	0.14	1.0	180	0.15	1.0	600	0.18	1.0	45	0.12	0.8	35	0.11	0.3
	T9315	0.4	285	0.17	1.0	–	–	–	270	0.17	1.0	–	–	–	–	–	–	55	0.13	0.3
	T9325	0.4	255	0.17	1.0	150	0.15	1.0	240	0.17	1.0	–	–	–	55	0.15	0.8	–	–	–
CNMG 120408E-SF	H07	0.8	–	–	–	95	0.18	1.0	155	0.20	1.0	495	0.24	1.0	50	0.15	0.8	–	–	–
	T6310	0.8	200	0.20	1.0	140	0.18	1.0	160	0.20	1.0	600	0.24	1.0	60	0.14	0.8	40	0.10	0.7
	T7325	0.8	230	0.20	1.0	175	0.18	1.0	–	–	–	–	–	–	70	0.16	0.8	–	–	–
	T7335	0.8	220	0.20	1.0	170	0.18	1.0	–	–	–	–	–	–	70	0.16	0.8	–	–	–
	T8315	0.8	210	0.20	1.0	125	0.18	1.0	195	0.20	1.0	630	0.24	1.0	50	0.14	0.8	40	0.10	0.7
	T8430	0.8	230	0.20	1.0	125	0.18	1.0	185	0.20	1.0	630	0.24	1.0	45	0.14	0.8	35	0.10	0.7
	T9325	0.8	280	0.20	1.0	165	0.18	1.0	265	0.20	1.0	–	–	–	60	0.16	0.8	–	–	–
CNMG 120412E-SF	T6310	1.2	190	0.25	1.5	135	0.23	1.5	150	0.25	1.5	570	0.30	1.5	55	0.18	1.2	35	0.13	1.0
	T8315	1.2	200	0.25	1.5	120	0.23	1.5	190	0.25	1.5	600	0.30	1.5	50	0.18	1.2	40	0.13	1.0
	T8430	1.2	210	0.25	1.5	115	0.23	1.5	175	0.25	1.5	585	0.30	1.5	45	0.18	1.2	35	0.13	1.0

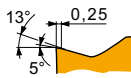

SM geometry with positive design for medium machining, and continuous to interrupted cuts.

CNMG 120404E-SM	T6310	0.4	155	0.20	2.0	110	0.18	2.0	125	0.20	2.0	465	0.24	2.0	45	0.18	1.6	30	0.13	0.3
	T7325	0.4	180	0.20	2.0	140	0.18	2.0	–	–	–	–	–	–	55	0.18	1.6	–	–	–
	T7335	0.4	175	0.20	2.0	135	0.18	2.0	–	–	–	–	–	–	55	0.18	1.6	–	–	–
	T8430	0.4	180	0.20	2.0	95	0.18	2.0	145	0.20	2.0	495	0.24	2.0	35	0.18	1.6	30	0.13	0.3
	T9315	0.4	245	0.20	2.0	–	–	–	230	0.20	2.0	–	–	–	–	–	–	45	0.13	0.3
	T9325	0.4	220	0.20	2.0	130	0.18	2.0	205	0.20	2.0	–	–	–	45	0.18	1.6	–	–	–
	T9325	0.4	220	0.20	2.0	130	0.18	2.0	205	0.20	2.0	–	–	–	45	0.18	1.6	–	–	–
CNMG 120408E-SM	T6310	0.8	175	0.25	2.0	125	0.23	2.0	140	0.25	2.0	525	0.30	2.0	50	0.20	1.6	35	0.13	0.7
	T7325	0.8	200	0.25	2.0	155	0.23	2.0	–	–	–	–	–	–	65	0.20	1.6	–	–	–
	T7335	0.8	190	0.25	2.0	145	0.23	2.0	–	–	–	–	–	–	60	0.20	1.6	–	–	–
	T8430	0.8	195	0.25	2.0	105	0.23	2.0	160	0.25	2.0	540	0.30	2.0	40	0.20	1.6	30	0.13	0.7
	T9315	0.8	265	0.25	2.0	–	–	–	250	0.25	2.0	–	–	–	–	–	–	50	0.13	0.7
	T9325	0.8	235	0.25	2.0	140	0.23	2.0	220	0.25	2.0	–	–	–	50	0.20	1.6	–	–	–
	T9325	0.8	235	0.25	2.0	140	0.23	2.0	220	0.25	2.0	–	–	–	50	0.20	1.6	–	–	–
CNMG 120412E-SM	T6310	1.2	175	0.30	2.0	125	0.27	2.0	140	0.30	2.0	525	0.36	2.0	50	0.24	1.6	35	0.15	1.0
	T7325	1.2	195	0.30	2.0	150	0.27	2.0	–	–	–	–	–	–	60	0.24	1.6	–	–	–
	T7335	1.2	190	0.30	2.0	145	0.27	2.0	–	–	–	–	–	–	60	0.24	1.6	–	–	–
	T8430	1.2	190	0.30	2.0	105	0.27	2.0	155	0.30	2.0	525	0.36	2.0	40	0.24	1.6	30	0.15	1.0
	T9315	1.2	260	0.30	2.0	–	–	–	245	0.30	2.0	–	–	–	–	–	–	50	0.15	1.0
	T9325	1.2	235	0.30	2.0	140	0.27	2.0	220	0.30	2.0	–	–	–	50	0.24	1.6	–	–	–
	T9325	1.2	235	0.30	2.0	140	0.27	2.0	220	0.30	2.0	–	–	–	50	0.24	1.6	–	–	–
CNMG 160608E-SM	T7325	0.8	185	0.26	3.0	140	0.23	3.0	–	–	–	–	–	–	60	0.23	2.4	–	–	–
	T8430	0.8	180	0.26	3.0	95	0.23	3.0	145	0.26	3.0	495	0.31	3.0	35	0.23	2.4	30	0.13	0.7
	T9325	0.8	225	0.26	3.0	135	0.23	3.0	210	0.26	3.0	–	–	–	50	0.23	2.4	–	–	–
CNMG 160612E-SM	T6310	1.2	170	0.30	3.0	120	0.27	3.0	135	0.30	3.0	510	0.36	3.0	50	0.27	2.4	30	0.15	1.0
	T7325	1.2	190	0.30	3.0	145	0.27	3.0	–	–	–	–	–	–	60	0.27	2.4	–	–	–
	T7335	1.2	180	0.30	3.0	140	0.27	3.0	–	–	–	–	–	–	55	0.27	2.4	–	–	–
	T9315	1.2	250	0.30	3.0	–	–	–	235	0.30	3.0	–	–	–	–	–	–	50	0.15	1.0
	T9325	1.2	225	0.30	3.0	135	0.27	3.0	210	0.30	3.0	–	–	–	50	0.27	2.4	–	–	–
CNMG 190612E-SM	T6310	1.2	165	0.30	4.0	115	0.27	4.0	130	0.30	4.0	495	0.36	4.0	45	0.27	3.2	30	0.15	1.0
	T7325	1.2	185	0.30	4.0	140	0.27	4.0	–	–	–	–	–	–	60	0.27	3.2	–	–	–
	T7335	1.2	175	0.30	4.0	135	0.27	4.0	–	–	–	–	–	–	55	0.27	3.2	–	–	–
	T9315	1.2	245	0.30	4.0	–	–	–	230	0.30	4.0	–	–	–	–	–	–	45	0.15	1.0



Suitability and starting values for cutting speed (vc), feed (f) and depth of cut (ap). Refer to our Machining Calculator app for further calculations.

Product	RE (mm)	P			M			K			N			S			H		
		vc (m/min)	f (mm/rev)	ap (mm)	vc (m/min)	f (mm/rev)	ap (mm)	vc (m/min)	f (mm/rev)	ap (mm)	vc (m/min)	f (mm/rev)	ap (mm)	vc (m/min)	f (mm/rev)	ap (mm)	vc (m/min)	f (mm/rev)	ap (mm)

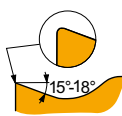

ER-SI geometry with positive right-handed design for fine-finish to semi-rough machining, and continuous cuts.

CNMG 120404ER-SI	T7335	0.4	215	0.20	1.7	165	0.18	1.7	-	-	-	-	-	-	65	0.18	1.4	-	-	-
	T8430	0.4	225	0.20	1.7	120	0.18	1.7	-	-	-	615	0.24	1.7	45	0.18	1.4	-	-	-
	T9325	0.4	270	0.20	1.7	160	0.18	1.7	-	-	-	-	-	-	60	0.18	1.4	-	-	-
CNMG 120408ER-SI	T7325	0.8	215	0.35	1.7	165	0.32	1.7	-	-	-	-	-	-	65	0.25	1.4	-	-	-
	T7335	0.8	205	0.35	1.7	155	0.32	1.7	-	-	-	-	-	-	65	0.25	1.4	-	-	-
	T8430	0.8	210	0.35	1.7	115	0.32	1.7	-	-	-	585	0.42	1.7	45	0.25	1.4	-	-	-
CNMG 120412ER-SI	T8430	1.2	225	0.35	1.7	120	0.32	1.7	-	-	-	615	0.42	1.7	45	0.25	1.4	-	-	-

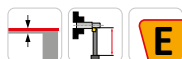
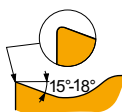

EL-SI geometry with positive left-handed design for fine-finish to semi-rough machining, and continuous cuts.

CNMG 120404EL-SI	T7335	0.4	215	0.20	1.7	165	0.18	1.7	-	-	-	-	-	65	0.18	1.4	-	-	-	
	T8430	0.4	225	0.20	1.7	120	0.18	1.7	-	-	-	615	0.24	1.7	45	0.18	1.4	-	-	-
	T9325	0.4	270	0.20	1.7	160	0.18	1.7	-	-	-	-	-	-	60	0.18	1.4	-	-	-
CNMG 120408EL-SI	T7325	0.8	215	0.35	1.7	165	0.32	1.7	-	-	-	-	-	65	0.25	1.4	-	-	-	
	T7335	0.8	205	0.35	1.7	155	0.32	1.7	-	-	-	-	-	65	0.25	1.4	-	-	-	
	T8430	0.8	210	0.35	1.7	115	0.32	1.7	-	-	-	585	0.42	1.7	45	0.25	1.4	-	-	-
CNMG 120412EL-SI	T8430	1.2	225	0.35	1.7	120	0.32	1.7	-	-	-	615	0.42	1.7	45	0.25	1.4	-	-	-

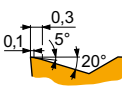

W-M wiper geometry for semi-rough to rough machining with increased feed rates and improved surface finish.

CNMG 120408W-M	T5315	0.8	230	0.45	1.5	-	-	-	215	0.45	1.5	-	-	-	-	-	-	-	-	-
	T9315	0.8	200	0.45	1.5	-	-	-	190	0.45	1.5	-	-	-	-	-	-	-	-	-
	T9325	0.8	185	0.45	1.5	-	-	-	175	0.45	1.5	-	-	-	-	-	-	-	-	-

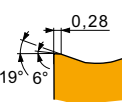

W-MR wiper geometry for finish to rough machining with increased feed rates and improved surface finish.

CNMG 120404W-MR	T9315	0.4	200	0.30	1.5	-	-	-	190	0.30	1.5	-	-	-	-	-	-	-	-	-
	T9325	0.4	180	0.30	1.5	105	0.27	1.5	170	0.30	1.5	-	-	-	-	-	-	-	-	-
CNMG 120408W-MR	T5315	0.8	230	0.45	1.5	-	-	-	215	0.45	1.5	-	-	-	-	-	-	-	-	-
	T9310	0.8	215	0.45	1.5	-	-	-	200	0.45	1.5	-	-	-	-	-	-	-	-	-
	T9315	0.8	200	0.45	1.5	-	-	-	190	0.45	1.5	-	-	-	-	-	-	-	-	-
CNMG 120412W-MR	T9325	0.8	185	0.45	1.5	110	0.41	1.5	175	0.45	1.5	-	-	-	-	-	-	-	-	-
	T5315	1.2	230	0.55	1.5	-	-	-	215	0.55	1.5	-	-	-	-	-	-	-	-	-
	T9310	1.2	210	0.55	1.5	-	-	-	195	0.55	1.5	-	-	-	-	-	-	-	-	-
	T9315	1.2	200	0.55	1.5	-	-	-	190	0.55	1.5	-	-	-	-	-	-	-	-	-
CNMG 120412W-MR	T9325	1.2	180	0.55	1.5	105	0.50	1.5	170	0.55	1.5	-	-	-	-	-	-	-	-	-



CNMM

	IC (mm)	D1 (mm)	L (mm)	S (mm)
1204	12.700	5.16	12.90	4.76
1606	15.875	6.35	16.10	6.35
1906	19.050	7.94	19.30	6.35
2509	25.400	9.12	25.80	9.53

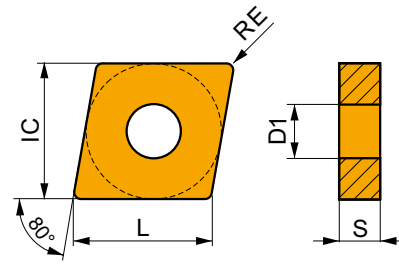

Suitability and starting values for cutting speed (vc), feed (f) and depth of cut (ap). Refer to our Machining Calculator app for further calculations.

Product	RE (mm)	P			M			K			N			S			H		
		vc (m/min)	f (mm/rev)	ap (mm)	vc (m/min)	f (mm/rev)	ap (mm)	vc (m/min)	f (mm/rev)	ap (mm)	vc (m/min)	f (mm/rev)	ap (mm)	vc (m/min)	f (mm/rev)	ap (mm)	vc (m/min)	f (mm/rev)	ap (mm)

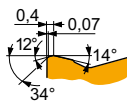

HR geometry for rough to heavy-rough machining, and continuous to interrupted cuts.

CNMM 190616E-HR	6640	1.6	75	0.60	10.0	45	0.54	10.0	70	0.60	10.0	-	-	-	-	-	-	-
	T8345	1.6	55	0.60	10.0	30	0.54	10.0	50	0.60	10.0	-	-	-	-	-	-	-
	T9325	1.6	105	0.60	10.0	60	0.54	10.0	95	0.60	10.0	-	-	-	-	-	-	-
	T9335	1.6	80	0.60	10.0	45	0.54	10.0	-	-	-	-	-	-	-	-	-	-
CNMM 190624E-HR	T8345	2.4	60	0.65	10.0	35	0.59	10.0	55	0.65	10.0	-	-	-	-	-	-	-
	T9315	2.4	115	0.65	10.0	-	-	-	105	0.65	10.0	-	-	-	-	-	-	-
	T9325	2.4	100	0.65	10.0	60	0.59	10.0	95	0.65	10.0	-	-	-	-	-	-	-
	T9335	2.4	85	0.65	10.0	50	0.59	10.0	-	-	-	-	-	-	-	-	-	-
CNMM 250924E-HR	6630	2.4	85	0.65	14.0	50	0.59	14.0	80	0.65	14.0	-	-	-	-	-	-	-
	6640	2.4	75	0.65	14.0	45	0.59	14.0	70	0.65	14.0	-	-	-	-	-	-	-
	T8345	2.4	55	0.65	14.0	30	0.59	14.0	50	0.65	14.0	-	-	-	-	-	-	-
	T9315	2.4	110	0.65	14.0	-	-	-	100	0.65	14.0	-	-	-	-	-	-	-
	T9325	2.4	100	0.65	14.0	60	0.59	14.0	95	0.65	14.0	-	-	-	-	-	-	-
T9335	2.4	80	0.65	14.0	45	0.59	14.0	-	-	-	-	-	-	-	-	-	-	

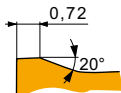

HR2 geometry for rough to heavy-rough machining, and continuous to interrupted cuts.

CNMM 190616-HR2	T9226	1.6	85	0.65	10.0	50	0.59	10.0	80	0.65	10.0	-	-	-	-	-	-	-
	T9315	1.6	110	0.65	10.0	-	-	-	100	0.65	10.0	-	-	-	-	-	-	-
	T9335	1.6	80	0.65	10.0	45	0.59	10.0	-	-	-	-	-	-	-	-	-	-
CNMM 190624-HR2	T9226	2.4	80	0.85	10.0	45	0.77	10.0	75	0.85	10.0	-	-	-	-	-	-	-
	T9315	2.4	100	0.85	10.0	-	-	-	95	0.85	10.0	-	-	-	-	-	-	-
CNMM 250924-HR2	T9315	2.4	100	0.85	12.0	-	-	-	95	0.85	12.0	-	-	-	-	-	-	-
	T9335	2.4	75	0.85	12.0	45	0.77	12.0	-	-	-	-	-	-	-	-	-	-

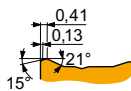

NR2 geometry for semi-rough to rough machining, and continuous to interrupted cuts.

CNMM 120408E-NR2	T7325	0.8	165	0.40	5.0	125	0.36	5.0	-	-	-	50	0.28	4.0	-	-	-
	T7335	0.8	155	0.40	5.0	120	0.36	5.0	-	-	-	50	0.28	4.0	-	-	-
	T8430	0.8	150	0.40	5.0	80	0.36	5.0	125	0.40	5.0	30	0.28	4.0	-	-	-
	T9315	0.8	205	0.40	5.0	-	-	-	190	0.40	5.0	-	-	-	-	-	-
	T9325	0.8	185	0.40	5.0	110	0.36	5.0	175	0.40	5.0	40	0.28	4.0	-	-	-
CNMM 120412E-NR2	T7335	1.2	155	0.45	5.0	120	0.41	5.0	-	-	-	50	0.32	4.0	-	-	-
	T8430	1.2	150	0.45	5.0	80	0.41	5.0	125	0.45	5.0	30	0.32	4.0	-	-	-
	T9325	1.2	185	0.45	5.0	110	0.41	5.0	175	0.45	5.0	40	0.32	4.0	-	-	-
CNMM 160608E-NR2	T8430	0.8	150	0.40	6.0	80	0.36	6.0	125	0.40	6.0	30	0.32	4.8	-	-	-
	T9325	0.8	180	0.40	6.0	105	0.36	6.0	170	0.40	6.0	40	0.32	4.8	-	-	-



Suitability and starting values for cutting speed (vc), feed (f) and depth of cut (ap). Refer to our Machining Calculator app for further calculations.

Product	RE (mm)	P			M			K			N			S			H		
		vc (m/min)	f (mm/rev)	ap (mm)	vc (m/min)	f (mm/rev)	ap (mm)	vc (m/min)	f (mm/rev)	ap (mm)	vc (m/min)	f (mm/rev)	ap (mm)	vc (m/min)	f (mm/rev)	ap (mm)	vc (m/min)	f (mm/rev)	ap (mm)

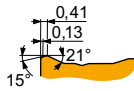

NR2 geometry for semi-rough to rough machining, and continuous to interrupted cuts.

CNMM 160612E-NR2	T7325	1.2	165	0.45	6.0	125	0.41	6.0	-	-	-	-	-	-	50	0.36	4.8	-	-	-
	T7335	1.2	155	0.45	6.0	120	0.41	6.0	-	-	-	-	-	-	50	0.36	4.8	-	-	-
	T8430	1.2	150	0.45	6.0	80	0.41	6.0	125	0.45	6.0	-	-	-	30	0.36	4.8	-	-	-
	T9325	1.2	185	0.45	6.0	110	0.41	6.0	175	0.45	6.0	-	-	-	40	0.36	4.8	-	-	-
CNMM 160616E-NR2	T7325	1.6	165	0.50	6.0	125	0.45	6.0	-	-	-	-	-	-	50	0.40	4.8	-	-	-
	T7335	1.6	160	0.50	6.0	120	0.45	6.0	-	-	-	-	-	-	50	0.40	4.8	-	-	-
	T9325	1.6	180	0.50	6.0	105	0.45	6.0	170	0.50	6.0	-	-	-	40	0.40	4.8	-	-	-
CNMM 190612E-NR2	T7325	1.2	155	0.45	9.0	120	0.41	9.0	-	-	-	-	-	-	50	0.36	7.2	-	-	-
	T7335	1.2	145	0.45	9.0	110	0.41	9.0	-	-	-	-	-	-	45	0.36	7.2	-	-	-
	T8430	1.2	140	0.45	9.0	75	0.41	9.0	115	0.45	9.0	-	-	-	30	0.36	7.2	-	-	-
	T9325	1.2	175	0.45	9.0	105	0.41	9.0	165	0.45	9.0	-	-	-	35	0.36	7.2	-	-	-
CNMM 190616E-NR2	T7325	1.6	160	0.50	9.0	120	0.45	9.0	-	-	-	-	-	-	50	0.40	7.2	-	-	-
	T7335	1.6	150	0.50	9.0	115	0.45	9.0	-	-	-	-	-	-	45	0.40	7.2	-	-	-
	T8430	1.6	140	0.50	9.0	75	0.45	9.0	115	0.50	9.0	-	-	-	30	0.40	7.2	-	-	-
	T9315	1.6	195	0.50	9.0	-	-	-	185	0.50	9.0	-	-	-	-	-	-	-	-	-
	T9325	1.6	175	0.50	9.0	105	0.45	9.0	165	0.50	9.0	-	-	-	35	0.40	7.2	-	-	-
CNMM 190624E-NR2	T7335	2.4	130	0.80	9.0	100	0.72	9.0	-	-	-	-	-	-	40	0.56	7.2	-	-	-
	T9325	2.4	150	0.80	9.0	90	0.72	9.0	140	0.80	9.0	-	-	-	30	0.56	7.2	-	-	-
CNMM 250924E-NR2	T7335	2.4	95	0.80	12.0	70	0.72	12.0	-	-	-	-	-	-	30	0.56	9.6	-	-	-
	T8430	2.4	80	0.80	12.0	45	0.72	12.0	65	0.80	12.0	-	-	-	15	0.56	9.6	-	-	-
	T9315	2.4	110	0.80	12.0	-	-	-	100	0.80	12.0	-	-	-	-	-	-	-	-	-
	T9325	2.4	100	0.80	12.0	60	0.72	12.0	95	0.80	12.0	-	-	-	20	0.56	9.6	-	-	-

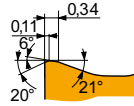

NRM geometry with positive design for semi-rough to rough machining, and continuous to interrupted cuts.

CNMM 250924-NRM	T7325	2.4	95	0.70	10.0	70	0.63	10.0	-	-	-	-	-	-	30	0.49	8.0	-	-	-
	T7335	2.4	90	0.70	10.0	70	0.63	10.0	-	-	-	-	-	-	25	0.49	8.0	-	-	-

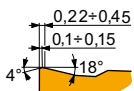

OR geometry for semi-rough to rough machining, and continuous to interrupted cuts.

CNMM 120408E-OR	T8430	0.8	150	0.40	5.0	80	0.36	5.0	125	0.40	5.0	-	-	-	30	0.28	4.0	-	-	-
	T9315	0.8	205	0.40	5.0	-	-	-	190	0.40	5.0	-	-	-	-	-	-	-	-	-
	T9325	0.8	185	0.40	5.0	110	0.36	5.0	175	0.40	5.0	-	-	-	40	0.28	4.0	-	-	-
	T9335	0.8	160	0.40	5.0	95	0.36	5.0	-	-	-	-	-	-	35	0.28	4.0	-	-	-
CNMM 120412E-OR	T9315	1.2	205	0.45	5.0	-	-	-	190	0.45	5.0	-	-	-	-	-	-	-	-	-
	T9325	1.2	185	0.45	5.0	110	0.41	5.0	175	0.45	5.0	-	-	-	40	0.36	4.0	-	-	-
	T9335	1.2	165	0.45	5.0	95	0.41	5.0	-	-	-	-	-	-	35	0.36	4.0	-	-	-
CNMM 120416E-OR	T9325	1.6	190	0.50	5.0	110	0.45	5.0	180	0.50	5.0	-	-	-	40	0.40	4.0	-	-	-
CNMM 160608E-OR	T9315	0.8	205	0.40	6.0	-	-	-	190	0.40	6.0	-	-	-	-	-	-	-	-	-
	T9325	0.8	180	0.40	6.0	105	0.36	6.0	170	0.40	6.0	-	-	-	40	0.32	4.8	-	-	-
CNMM 160612E-OR	T8430	1.2	150	0.45	6.0	80	0.41	6.0	125	0.45	6.0	-	-	-	30	0.36	4.8	-	-	-
	T9315	1.2	205	0.45	6.0	-	-	-	190	0.45	6.0	-	-	-	-	-	-	-	-	-
	T9325	1.2	185	0.45	6.0	110	0.41	6.0	175	0.45	6.0	-	-	-	40	0.36	4.8	-	-	-
CNMM 160616E-OR	T9315	1.6	205	0.50	6.0	-	-	-	190	0.50	6.0	-	-	-	-	-	-	-	-	-
	T9325	1.6	180	0.50	6.0	105	0.45	6.0	170	0.50	6.0	-	-	-	40	0.40	4.8	-	-	-
CNMM 190612E-OR	T8430	1.2	140	0.45	9.0	75	0.41	9.0	115	0.45	9.0	-	-	-	30	0.36	7.2	-	-	-
	T9315	1.2	195	0.45	9.0	-	-	-	185	0.45	9.0	-	-	-	-	-	-	-	-	-
	T9325	1.2	175	0.45	9.0	105	0.41	9.0	165	0.45	9.0	-	-	-	35	0.36	7.2	-	-	-
	T9335	1.2	150	0.45	9.0	90	0.41	9.0	-	-	-	-	-	-	30	0.36	7.2	-	-	-
CNMM 190616E-OR	T8430	1.6	140	0.50	9.0	75	0.45	9.0	115	0.50	9.0	-	-	-	30	0.40	7.2	-	-	-
	T9315	1.6	195	0.50	9.0	-	-	-	185	0.50	9.0	-	-	-	-	-	-	-	-	-
	T9325	1.6	175	0.50	9.0	105	0.45	9.0	165	0.50	9.0	-	-	-	35	0.40	7.2	-	-	-
	T9335	1.6	155	0.50	9.0	90	0.45	9.0	-	-	-	-	-	-	30	0.40	7.2	-	-	-



Suitability and starting values for cutting speed (vc), feed (f) and depth of cut (ap). Refer to our Machining Calculator app for further calculations.

Product	RE (mm)	P			M			K			N			S			H		
		vc (m/min)	f (mm/rev)	ap (mm)	vc (m/min)	f (mm/rev)	ap (mm)	vc (m/min)	f (mm/rev)	ap (mm)	vc (m/min)	f (mm/rev)	ap (mm)	vc (m/min)	f (mm/rev)	ap (mm)	vc (m/min)	f (mm/rev)	ap (mm)

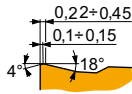

OR geometry for semi-rough to rough machining, and continuous to interrupted cuts.

CNMM 190624E-OR	T9315	2.4	165	0.80	9.0	—	—	—	155	0.80	9.0	—	—	—	—	—	—	—	—
	T9325	2.4	150	0.80	9.0	90	0.72	9.0	140	0.80	9.0	—	—	—	30	0.56	7.2	—	—
CNMM 250924E-OR	6630	2.4	80	1.00	12.0	45	0.90	12.0	75	1.00	12.0	—	—	—	20	0.70	9.6	—	—
	T8430	2.4	75	1.00	12.0	40	0.90	12.0	60	1.00	12.0	—	—	—	15	0.70	9.6	—	—
	T9315	2.4	100	1.00	12.0	—	—	—	95	1.00	12.0	—	—	—	—	—	—	—	—
	T9325	2.4	95	1.00	12.0	55	0.90	12.0	90	1.00	12.0	—	—	—	20	0.70	9.6	—	—
	T9335	2.4	75	1.00	12.0	45	0.90	12.0	—	—	—	—	—	—	15	0.70	9.6	—	—

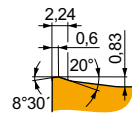

Geometry 923 for semi-rough to heavy-rough machining, and continuous to heavy interrupted cuts.

CNMM 250924S-923	T8430	2.4	75	0.85	12.0	40	0.77	12.0	60	0.85	12.0	—	—	—	15	0.60	9.6	—	—
	T9335	2.4	75	0.85	12.0	45	0.77	12.0	—	—	—	—	—	—	15	0.60	9.6	—	—

CNMX 19



	IC (mm)	D1 (mm)	L (mm)	S (mm)
1907	19.050	7.75	19.30	7.94
1911	19.050	7.75	19.30	11.00

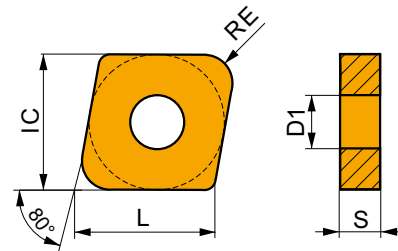

Suitability and starting values for cutting speed (vc), feed (f) and depth of cut (ap). Refer to our Machining Calculator app for further calculations.

Product	RE (mm)	P			M			K			N			S			H		
		vc (m/min)	f (mm/rev)	ap (mm)	vc (m/min)	f (mm/rev)	ap (mm)	vc (m/min)	f (mm/rev)	ap (mm)	vc (m/min)	f (mm/rev)	ap (mm)	vc (m/min)	f (mm/rev)	ap (mm)	vc (m/min)	f (mm/rev)	ap (mm)

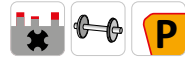
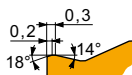

RF geometry for semi-rough to rough machining, and continuous to interrupted cuts.

CNMX 190740SN-RF	T5315	4.0	80	0.85	4.0	—	—	—	75	0.85	4.0	—	—	—	—	—	—	15	0.43	2.7
	T9315	4.0	80	0.85	4.0	—	—	—	75	0.85	4.0	—	—	—	—	—	—	15	0.43	2.7
S-CNMX 190740SN-RF*	T9325	4.0	70	0.85	4.0	—	—	—	65	0.85	4.0	—	—	—	—	—	—	—	—	—
CNMX 191140SN-RF	T9315	4.0	80	0.85	4.0	—	—	—	75	0.85	4.0	—	—	—	—	—	—	15	0.43	2.7

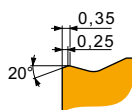

TF geometry for semi-rough to rough machining, and continuous to interrupted cuts.

CNMX 191140SN-TF	T9310	4.0	85	0.80	4.5	—	—	—	80	0.80	4.5	—	—	—	—	—	—	15	0.40	2.7
	T9315	4.0	80	0.80	4.5	—	—	—	75	0.80	4.5	—	—	—	—	—	—	15	0.40	2.7
	T9325	4.0	70	0.80	4.5	—	—	—	65	0.80	4.5	—	—	—	—	—	—	—	—	—



Suitability and starting values for cutting speed (vc), feed (f) and depth of cut (ap). Refer to our Machining Calculator app for further calculations.

Product	RE (mm)	P			M			K			N			S			H			
		vc (m/min)	f (mm/rev)	ap (mm)	vc (m/min)	f (mm/rev)	ap (mm)	vc (m/min)	f (mm/rev)	ap (mm)	vc (m/min)	f (mm/rev)	ap (mm)	vc (m/min)	f (mm/rev)	ap (mm)	vc (m/min)	f (mm/rev)	ap (mm)	
 TF1 geometry for finish to semi-rough machining, continuous to interrupted cuts.																				
S-CNMX 191140SN-TF1*	T9315	4.0	80	0.85	4.0	-	-	-	75	0.85	2.0	-	-	-	-	-	-	15	0.40	1.5
 TF2 geometry for finish to semi-rough machining, continuous to interrupted cuts.																				
S-CNMX 191140SN-TF2*	T9315	4.0	80	0.85	4.0	-	-	-	75	0.85	2.0	-	-	-	-	-	-	15	0.40	1.5

* Special items



DCBN(RL) EXT



External Double Clamp Turning Holder with 75° Cutting Angle for CN.. Insert

External Right/Left hand double clamp 75° tool holder. Suited for longitudinal and face turning without shoulder and chamfering with negative CN.. 12 up to 19 size inserts. Available with shanks 20x20 up to 40x40 mm. Body treated for longer tool life.

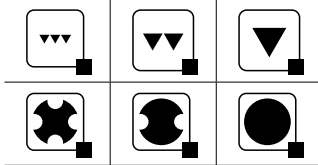
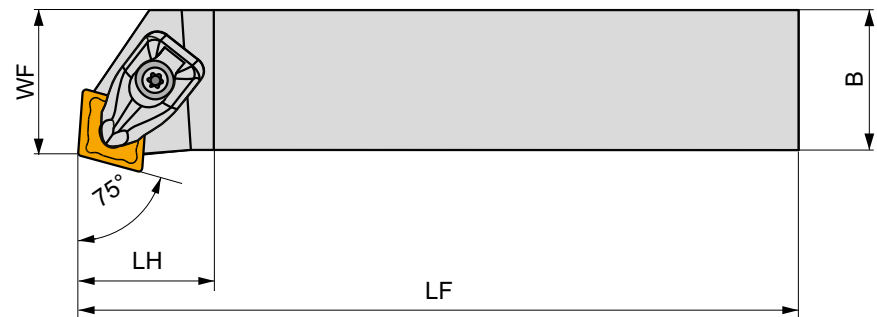

Product	H	B	HF	WF	LF	LH	LAMS	GAMO	kg			
	(mm)	(mm)	(mm)	(mm)	(mm)	(mm)	(°)	(°)				
R DCBNR 2020 K 12	20	20	20	17	125	34.2	-6	-6	0.43	GI043	DC12	AT001
DCBNR 2525 M 12	25	25	25	22	150	34.6	-6	-6	0.76	GI043	DC12	AT001
DCBNR 3225 P 12	32	25	32	22	170	34.6	-6	-6	1.09	GI043	DC12	AT001
DCBNR 2525 M 16	25	25	25	22	150	41.5	-6	-6	0.80	GI050	DC16	AT005
DCBNR 3225 P 16	32	25	32	22	170	32	-6	-6	1.11	GI050	DC16	AT005
DCBNR 3232 P 19	32	32	32	27	170	46.1	-6	-6	1.39	GI042	DC19	-
DCBNR 4040 S 19	40	40	40	35	250	46.7	-6	-6	3.16	GI042	DC19	-
L DCBNL 2020 K 12	20	20	20	17	125	34.2	-6	-6	0.43	GI043	DC12	AT001
DCBNL 2525 M 12	25	25	25	22	150	34.6	-6	-6	0.76	GI043	DC12	AT001
DCBNL 3225 P 12	32	25	32	22	170	34.6	-6	-6	1.09	GI043	DC12	AT001
DCBNL 2525 M 16	25	25	25	22	150	41.5	-6	-6	0.79	GI050	DC16	AT005
DCBNL 3225 P 16	32	25	32	22	170	32	-6	-6	1.11	GI050	DC16	AT005
DCBNL 3232 P 19	32	32	32	27	170	46.1	-6	-6	1.39	GI042	DC19	-



GI042

CN.. 1906..

GI043

CN.. 1204..

GI050

CN.. 1606..



DC12

DCS 12

3.9

DCS 234-01

US 2002-T15P

FLAGT15P/3,5

-

DC16

DCS 16

6.4

DCS 234-03

US 2007-T20P

-

LKT20P

DC19

DCS 19

6.4





DCS 236-01

US 2007-T20P

-

LKT20P



			
AT001a	CN.. 1207..	-	DCS 234-02
AT005a	CN.. 1607..	-	DCS 234-04
AT001b	CER CN.N 1204..	DCS 12C4	-
AT001c	CER CN.A 1204..	DCS 12C2	-
AT005b	CER CN.N 1606..	DCS 16C4	-
AT005c	CER CN.A 1606..	DCS 16C2	-



DCLN(RL) EXT



PRAMET

D

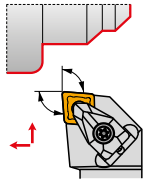

External Double Clamp Turning Holder with 95° Cutting Angle for CN.. Insert

External Right/Left hand double clamp 95° tool holder. Suited for longitudinal turning, chamfering and facing with shoulder, using negative CN.. 09 up to 19 size inserts and available in 16x16 up to 40x40 mm shanks. Body treated for longer tool life.

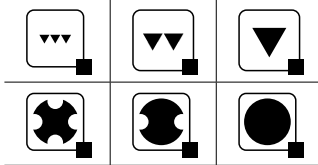
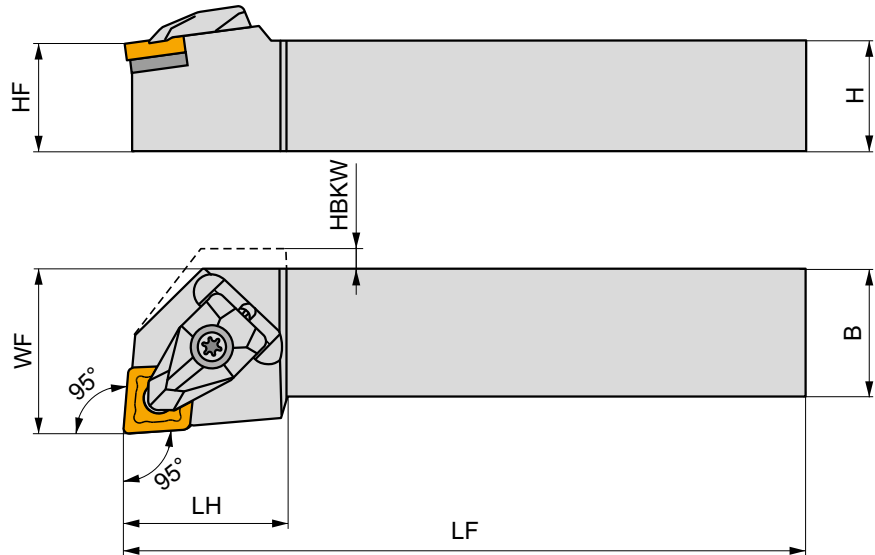

Product	H	B	HF	WF	LF	LH	HBKW	LAMS	GAMO	kg			
	(mm)	(mm)	(mm)	(mm)	(mm)	(mm)	(mm)	(°)	(°)				
R DCLNR 1616 H 09	16	16	16	20	100	25	-	-6	-6	0.27	G1133	DC09	-
DCLNR 2020 K 09	20	20	20	25	125	25	-	-6	-6	0.44	G1133	DC09	-
DCLNR 2525 M 09	25	25	25	32	150	25	-	-6	-6	0.78	G1133	DC09	-
DCLNR 1616 H 12	16	16	16	20	100	32.3	4.5	-6	-6	0.26	G1043	DC12	AT001
DCLNR 2020 K 12	20	20	20	25	125	30	-	-6	-6	0.44	G1043	DC12	AT001
DCLNR 2525 M 12	25	25	25	32	150	30	-	-6	-6	0.78	G1043	DC12	AT001
DCLNR 3225 P 12	32	25	32	32	170	30	-	-6	-6	1.10	G1043	DC12	AT001
DCLNR 2525 M 16	25	25	25	32	150	39	-	-6	-6	0.81	G1050	DC16	AT005
DCLNR 3225 P 16	32	25	32	32	170	35	-	-6	-6	1.20	G1050	DC16	AT005
DCLNR 3232 P 19	32	32	32	40	170	40	-	-6	-6	1.55	G1042	DC19	-
DCLNR 4040 S 19	40	40	40	50	250	43.4	-	-6	-6	3.26	G1042	DC19	-
L DCLNL 1616 H 09	16	16	16	20	100	24.8	-	-6	-6	0.22	G1133	DC09	-
DCLNL 2020 K 09	20	20	20	25	125	24.8	-	-6	-6	0.42	G1133	DC09	-
DCLNL 2525 M 09	25	25	25	32	150	24.8	-	-6	-6	0.76	G1133	DC09	-
DCLNL 1616 H 12	16	16	16	20	100	32.2	4.5	-6	-6	0.26	G1043	DC12	AT001
DCLNL 2020 K 12	20	20	20	25	125	32	-	-6	-6	0.44	G1043	DC12	AT001
DCLNL 2525 M 12	25	25	25	32	150	32	-	-6	-6	0.78	G1043	DC12	AT001
DCLNL 3225 P 12	32	25	32	32	170	32	-	-6	-6	1.10	G1043	DC12	AT001
DCLNL 2525 M 16	25	25	25	32	150	39	-	-6	-6	0.81	G1050	DC16	AT005
DCLNL 3225 P 16	32	25	32	32	170	39	-	-6	-6	1.20	G1050	DC16	AT005
DCLNL 3232 P 19	32	32	32	40	170	43.2	-	-6	-6	1.51	G1042	DC19	-
DCLNL 4040 S 19	40	40	40	50	250	43.4	-	-6	-6	3.26	G1042	DC19	-



G1042
G1043



CN.. 1906..
CN.. 1204..



GI050

CN.. 1606..

GI133

CN.. 0903..



DC09

DCS 09

1.7

DCS 236-04

US 2004-T09P

FLAG T09P

-

DC12

DCS 12

3.9

DCS 234-01

US 2002-T15P

FLAG T15P/3,5

-

DC16

DCS 16

6.4

DCS 234-03

US 2007-T20P

-

LK T20P

DC19

DCS 19

6.4

DCS 236-01

US 2007-T20P

-

LK T20P

DC112

DCS 12

3.9

DCS 236-03

US 2002-T15P

FLAG T15P/3,5

-



AT001a

CN.. 1207..

-

DCS 234-02

AT005a

CN.. 1607..

-

DCS 234-04

AT001b

CER CN.N 1204..

DCS 12C4

-

AT001c

CER CN.A 1204..

DCS 12C2

-

AT005b

CER CN.N 1606..

DCS 16C4

-

AT005c

CER CN.A 1606..

DCS 16C2

-



PCBN(RL) EXT



PRAMET

P



External Lever Lock Turning Holder with 75° Cutting Angle for CN.. Insert

External Right/Left hand lever lock 75° tool holder. Suited for external chamfering, taper and longitudinal turning without shoulder, using negative CN.. 12, 16, 19 or 25 size inserts. Available in 20x20 up to 50x50 mm shanks. Body treated for longer tool life.

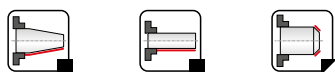
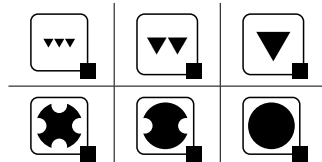
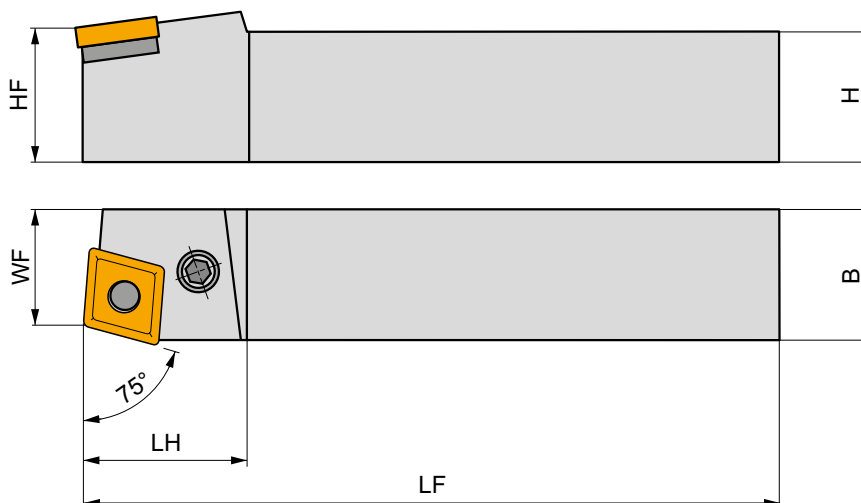
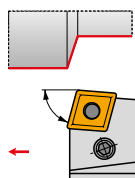

Product	H	B	HF	WF	LF	LH	LAMS	GAMO	kg	G1043	PC22	
	(mm)	(mm)	(mm)	(mm)	(mm)	(mm)	(°)	(°)				
R	PCBNR 2020 K 12	20	20	20	17	125	36	-6	-6	0.43	G1043	PC22
	PCBNR 2525 M 12	25	25	25	22	150	36	-6	-6	0.63	G1043	PC20
	PCBNR 3225 P 12	32	25	32	22	170	36	-6	-6	0.70	G1043	PC20
	PCBNR 3232 P 16	32	32	32	27	170	40	-6	-6	1.36	G1050	PC40
	PCBNR 3232 P 19	32	32	32	27	170	45	-6	-6	1.10	G1042	PC50
	PCBNR 4040 S 19	40	40	40	35	250	45	-6	-6	3.15	G1042	PC50
	PCBNR 4040 S 25	40	40	40	35	250	45	-6	-6	3.10	G1062	PC60
	PCBNR 5050 T 25	50	50	50	43	300	50	-6	-6	5.80	G1062	PC60
L	PCBNL 2020 K 12	20	20	20	17	125	36	-6	-6	0.38	G1043	PC22
	PCBNL 2525 M 12	25	25	25	22	150	36	-6	-6	0.73	G1043	PC20
	PCBNL 3225 P 12	32	25	32	22	170	36	-6	-6	0.70	G1043	PC20
	PCBNL 3232 P 16	32	32	32	27	170	40	-6	-6	1.25	G1050	PC40
	PCBNL 3232 P 19	32	32	32	27	170	45	-6	-6	1.10	G1042	PC50
	PCBNL 4040 S 19	40	40	40	35	250	45	-6	-6	3.15	G1042	PC50
	PCBNL 4040 S 25	40	40	40	35	250	45	-6	-6	3.15	G1062	PC60
	PCBNL 5050 T 25	50	50	50	43	300	50	-6	-6	5.80	G1062	PC60



G1042

CN.. 1906..

G1043

CN.. 1204..











G1050

CN.. 1606..

G1062

CN.. 2509..



				 Nm					
PC20	CNU 120312	PU 02	US 35	6.0	M 8x1	22.5	NT 05	MT 05	HXX 4
PC22	CNU 120312	PU 02	US 42	6.0	M 8x1	21	NT 05	MT 05	HXX 4
PC40	CNU 150312	PU 04	US 36	6.0	M 8x1	26	NT 07	MT 07	HXX 4
PC50	CNU 190416	PU 05	US 38	8.0	M 10x1	29	NT 06	MT 06	HXX 5
PC60	CNU 250620	PU 06	US 39	8.0	M 10x1	33	NT 08	MT 08	HXX 5



PCLN(RL) EXT



External Lever Lock Turning Holder with 95° Cutting Angle for CN.. Insert

External Right/Left hand lever lock 95° tool holder. Suited for external taper, face, longitudinal with shoulder turning and chamfering with negative CN.. 12, 16, 19 or 25 size inserts. Available in 20x20 up to 50x50 mm shanks. Body treated for longer tool life.

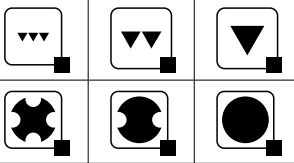
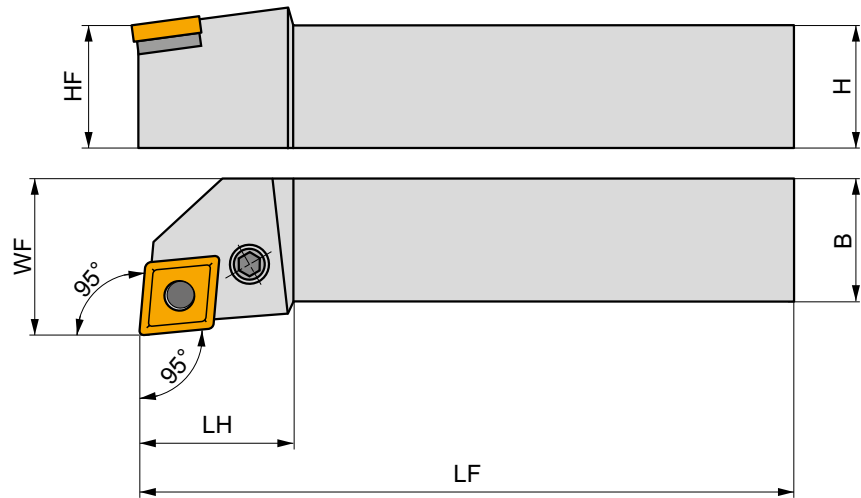
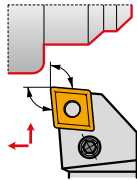

Product	H	B	HF	WF	LF	LH	LAMS	GAMO	kg	G1043	PC22
	(mm)	(mm)	(mm)	(mm)	(mm)	(mm)	(°)	(°)			
R PCLNR 2020 K 12	20	20	20	25	125	36	-6	-6	0.44	G1043	PC22
PCLNR 2525 M 12	25	25	25	32	150	36	-6	-6	0.68	G1043	PC20
PCLNR 3225 P 12	32	25	32	32	170	36	-6	-6	0.98	G1043	PC20
PCLNR 3225 P 16	32	25	32	32	170	40	-6	-6	1.10	G1050	PC40
PCLNR 3232 P 19	32	32	32	40	170	45	-6	-6	1.40	G1042	PC50
PCLNR 4040 R 19	40	40	40	50	200	45	-6	-6	2.50	G1042	PC50
PCLNR 4040 S 19	40	40	40	50	250	45	-6	-6	3.19	G1042	PC50
PCLNR 4040 S 25	40	40	40	50	250	45	-6	-6	3.15	G1062	PC60
PCLNR 5050 T 25	50	50	50	60	300	50	-6	-6	5.90	G1062	PC60
L PCLNL 2020 K 12	20	20	20	25	125	36	-6	-6	0.42	G1043	PC22
PCLNL 2525 M 12	25	25	25	32	150	36	-6	-6	0.75	G1043	PC20
PCLNL 3225 P 12	32	25	32	32	170	36	-6	-6	1.10	G1043	PC20
PCLNL 3225 P 16	32	25	32	32	170	40	-6	-6	1.10	G1050	PC40
PCLNL 3232 P 19	32	32	32	40	170	45	-6	-6	1.42	G1042	PC50
PCLNL 4040 R 19	40	40	40	50	200	45	-6	-6	2.60	G1042	PC50
PCLNL 4040 S 19	40	40	40	50	250	45	-6	-6	3.19	G1042	PC50
PCLNL 4040 S 25	40	40	40	50	250	45	-6	-6	2.45	G1062	PC60
PCLNL 5050 T 25	50	50	50	60	300	50	-6	-6	5.90	G1062	PC60



G1042

CN.. 1906..

G1043

CN.. 1204..











G1050

CN.. 1606..

G1062

CN.. 2509..



									
PC20	CNU 120312	PU 02	US 35	6.0	M 8x1	22.5	NT 05	MT 05	HXX 4
PC22	CNU 120312	PU 02	US 42	6.0	M 8x1	21	NT 05	MT 05	HXX 4
PC40	CNU 150312	PU 04	US 36	6.0	M 8x1	26	NT 07	MT 07	HXX 4
PC50	CNU 190416	PU 05	US 38	8.0	M 10x1	29	NT 06	MT 06	HXX 5
PC60	CNU 250620	PU 06	US 39	8.0	M 10x1	33	NT 08	MT 08	HXX 5



C.-DCLN(RL) EXT



Ext. PSC Quick Change Tool, Double Clamp, 95° Cutting Angle for CN.. Insert

External Right/Left hand double clamp tool, through coolant, with 95° cutting angle for longitudinal turning, chamfering and face turning with shoulder, using negative CN.. 12 up to 19 size inserts. Available with PSC (Polygon Shank Coupling) C3 up to C8. Body treated for longer tool life.

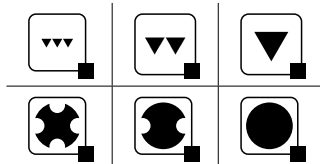
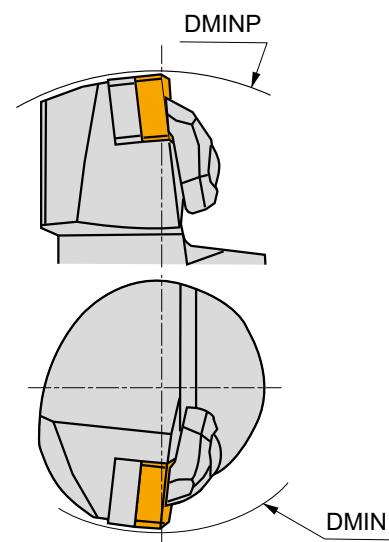
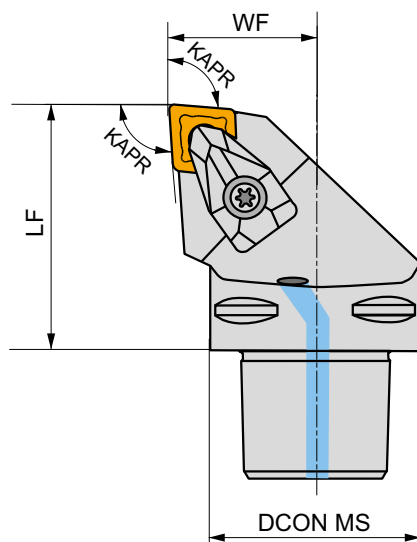
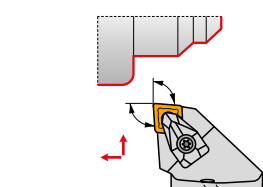









Product	DCON MS	DMIN	DMINP	WF	LF	KAPR	LAMS	GAMO					
	(mm)	(mm)	(mm)	(mm)	(mm)	(°)	(°)	(°)					
R C3-DCLNR-22045-12	32	60	121	22	45	95	-6	-6	✓	0.25	GI043	C-DC12	AT001
C4-DCLNR-27050-12	40	110	140	27	50	95	-6	-6	✓	0.44	GI043	C-DC12	AT001
C4-DCLNR-27055-16	40	125	145	27	55	95	-6	-6	✓	0.47	GI050	C-DC16	AT005
C5-DCLNR-35060-12	50	110	165	35	60	95	-6	-6	✓	0.79	GI043	C-DC12	AT001
C5-DCLNR-35060-16	50	125	165	35	60	95	-6	-6	✓	0.80	GI050	C-DC16	AT005
C6-DCLNR-45065-12	63	110	190	45	65	95	-6	-6	✓	1.32	GI043	C-DC12	AT001
C6-DCLNR-45065-16	63	125	190	45	65	95	-6	-6	✓	1.34	GI050	C-DC16	AT005
C6-DCLNR-45065-19	63	81	190	45	65	95	-6	-6	✓	1.34	GI042	C-DC19	-
C8-DCLNR-55080-19	80	100	250	55	80	95	-6	-6	✓	2.58	GI042	C-DC19	-
L C4-DCLNL-27050-12	40	110	140	27	50	95	-6	-6	✓	0.44	GI043	C-DC12	AT001
C4-DCLNL-27055-16	40	125	145	27	55	95	-6	-6	✓	0.47	GI050	C-DC16	AT005
C5-DCLNL-35060-12	50	110	165	35	60	95	-6	-6	✓	0.79	GI043	C-DC12	AT001
C5-DCLNL-35060-16	50	125	165	35	60	95	-6	-6	✓	0.80	GI050	C-DC16	AT005
C6-DCLNL-45065-12	63	110	190	45	65	95	-6	-6	✓	1.32	GI043	C-DC12	AT001
C6-DCLNL-45065-16	63	125	190	45	65	95	-6	-6	✓	1.34	GI050	C-DC16	AT005
C6-DCLNL-45065-19	63	81	190	45	65	95	-6	-6	✓	1.34	GI042	C-DC19	-
C8-DCLNL-55080-16	80	125	250	55	80	95	-6	-6	✓	2.58	GI050	C-DC16	AT005
C8-DCLNL-55080-19	80	100	250	55	80	95	-6	-6	✓	2.58	GI042	C-DC19	-







GI042
GI043
GI050

CN.. 1906..
CN.. 1204..
CN.. 1606..



		 Nm					
C-DC12	DCS 12	3.9	DCS 234-01	US 2002-T15P	FLAG T15P/3,5	–	CN 045-01
C-DC16	DCS 16	6.4	DCS 234-03	US 2007-T20P	–	LK T20P	CN 045-01
C-DC19	DCS 19	6.4	DCS 236-01	US 2007-T20P	–	LK T20P	CN 045-01

			
AT001a	CN.. 1207..	–	DCS 234-02
AT005a	CN.. 1607..	–	DCS 234-04
AT001b	CER CN.N 1204..	DCS 12C4	–
AT001c	CER CN.A 1204..	DCS 12C2	–
AT005b	CER CN.N 1606..	DCS 16C4	–
AT005c	CER CN.A 1606..	DCS 16C2	–



KHP-CBN(RL)



PRAMET

P



Modular KHP Lever Lock Turning Cartridge, 75° Cutting Angle for CN.. Inserts

Dovetailed Right/Left hand lever lock turning cartridge, 75° Cutting Angle, for mounting on DKH tool holder shank. Suited for heavy longitudinal turning without shoulder, face turning, taper and chamfer turning with negative CN.. 25 inserts. Tool holder treated for longer tool life.

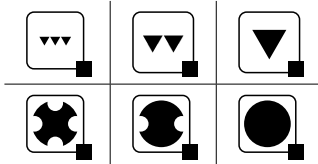
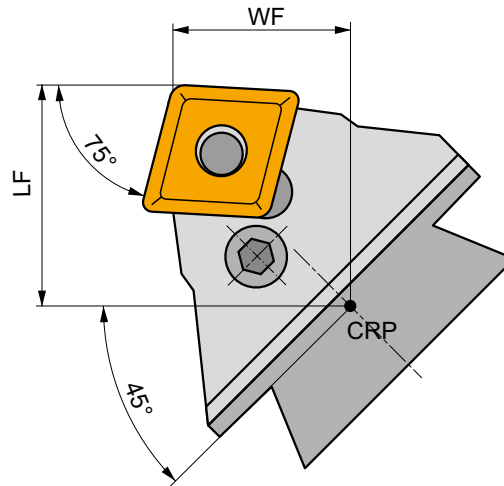
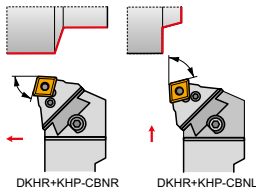

Product	WF (mm)	LF (mm)	LAMS (°)	GAMO (°)	kg		
R KHP-CBNR 25	32	47	-6	-6	1.54	GI062	PC60
L KHP-CBNL 25	32	47	-6	-6	1.54	GI062	PC60



GI062



CN.. 2509..



PC60



CNU 250620



PU 06



US 39



8.0



M 10x1



33



NT 08



MT 08



HXK 5



KHP-CLN(RL)



PRAMET

P



Modular KHP Lever Lock Turning Cartridge, 95° Cutting Angle for CN.. Inserts

Dovetailed Right/Left hand lever lock turning cartridge, 95° Cutting Angle, for mounting on DKH tool holder shank. Suited for heavy longitudinal turning with shoulder, face turning with shoulder, taper and chamfer turning with negative CN.. 19 or 25 insert. Tool holder treated for longer tool life.

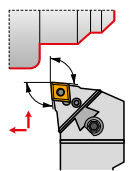

DKHR+KHP-CLNR

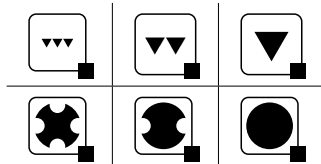
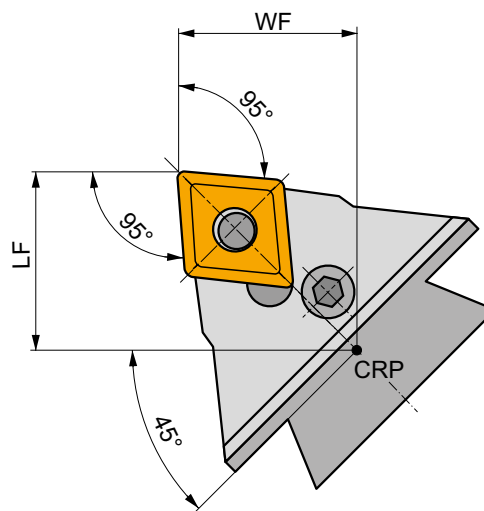

Product	WF	LF	LAMS	GAMO	kg		
	(mm)	(mm)	(°)	(°)			
R KHP-CLNR 19	35	45	-6	-6	1.30	GI042	PC50
	KHP-CLNR 25	35	45	-6	-6	1.25	GI062
L KHP-CLNL 19	35	45	-6	-6	1.30	GI042	PC50
	KHP-CLNL 25	35	45	-6	-6	1.25	GI062

GI042	CN.. 1906..
GI062	CN.. 2509..

PC50	CNU 190416	PU 05	US 38	8.0	M 10x1	29	NT 06	MT 06	HXK 5
PC60	CNU 250620	PU 06	US 39	8.0	M 10x1	33	NT 08	MT 08	HXK 5



DKH(RL)



External Tool Holder Shank for KHP/KHS Heavy Turning Cartridges

Dovetailed Right/Left hand modular tool shank for KHP/KHS cartridges. Suited for heavy turning applications. Available with shank size 40x50 up to 60x80 mm. Body treated for longer tool life.

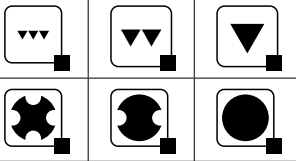
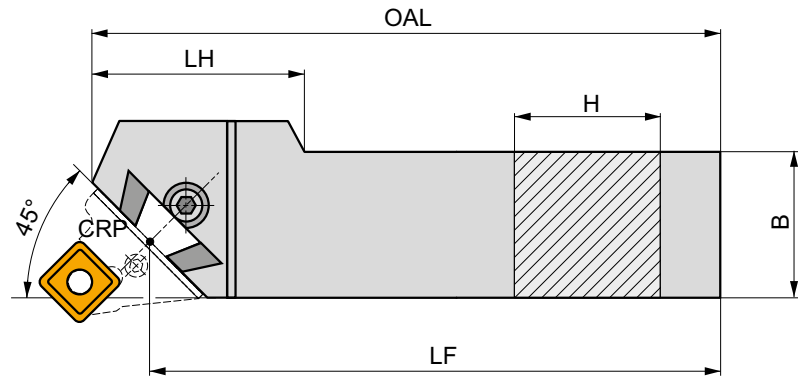
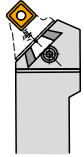

	Product	H	B	LF	OAL	LH	kg		
		(mm)	(mm)	(mm)	(mm)	(mm)			
R	DKHR 4050 V	40	50	400	425	100	7.10	GI098	DKH10
	DKHR 5060 W	50	60	450	475	110	11.30	GI098	DKH10
	DKHR 6080 W-A	60	80	450	485	90	19.65	GI098	DKH10
L	DKHL 4050 V	40	50	400	425	100	7.10	GI098	DKH10
	DKHL 5060 W	50	60	450	475	110	11.30	GI098	DKH10
	DKHL 6080 W-A	60	80	450	485	90	19.65	GI098	DKH10



GI098



KHP



KHS



DKH10



SR 14



HXK 10



DKT(RL)-A



PRAMET



Basic R/L handed tool shank for KTP cartridge heads.

Suited for railway wheels returning. Available in shank size 50x55 mm. Suited for Hegenscheidt machine tools. Body treated for longer tool life.

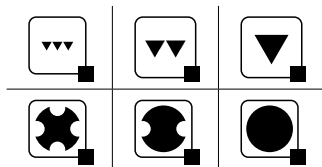
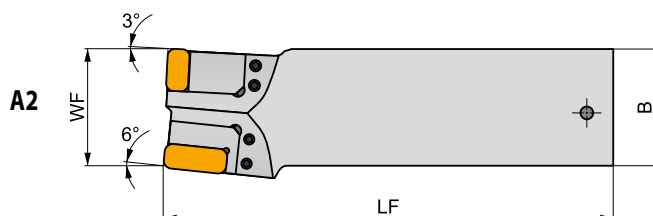
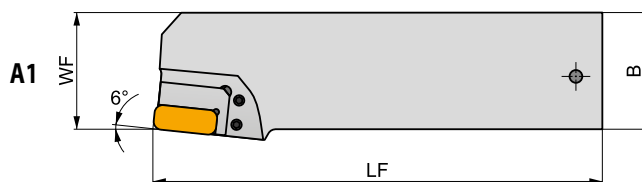
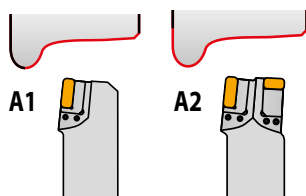

Product	H	B	LF	HF	WF	LAMS	GAMO	kg	G1189	G1391	G1188	G1390	DKT
	(mm)	(mm)	(mm)	(mm)	(mm)	(°)	(°)						
R DKTR 5055 X A1	50	55	210	44	55	-6	-6	3.70	G1189	G1391	DKT	DKT	DKT
DKTR 5055 X A2	50	55	210	44	55	-6	-6	3.70	G1189	G1391	DKT	DKT	DKT
L DKTL 5055 X A1	50	55	210	44	55	-6	-6	3.82	G1188	G1390	DKT	DKT	DKT
DKTL 5055 X A2	50	55	210	44	55	-6	-6	3.78	G1188	G1390	DKT	DKT	DKT

G1188	KTP-LANL 19	KTP-LANL 30	KTP-SANL 19	KTP-CANL 19xx	-	-	-	-	-	-
G1189	KTP-LANR 19	KTP-LANR 30	KTP-SANR 19	KTP-CANR 19xx	-	-	-	-	-	-
G1390	KTP-LANL 19	KTP-LANL 30	KTP-SANL 19	KTP-CANL 19xx	KTP-LFNR 19	KTP-SFNR 19	KTP-CFNR 19	KTP-LFNR 19	KTP-SFNR 19	KTP-CFNR 19
G1391	KTP-LANR 19	KTP-LANR 30	KTP-SANR 19	KTP-CANR 19xx	KTP-LFNL 19	KTP-SFNL 19	KTP-CFNL 19	KTP-LFNL 19	KTP-SFNL 19	KTP-CFNL 19

DKT	USS 0617	HXK 3



DKT(RL)-B



Basic R/L handed tool shank for KTP cartridge heads.

Suited for railway wheels returning. Available in shank size 50x49.5 mm. Suited for Rafamet UDA 125N machine tools. Body treated for longer tool life.

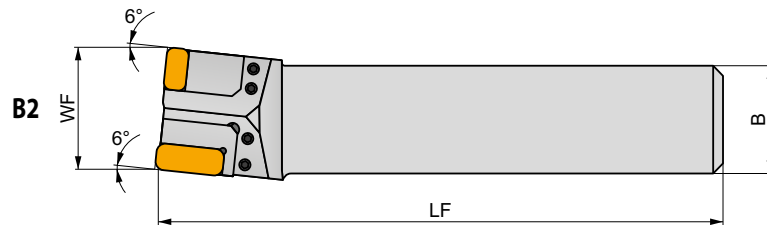
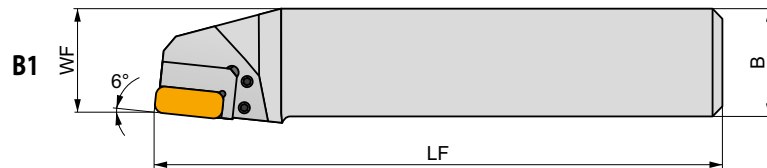
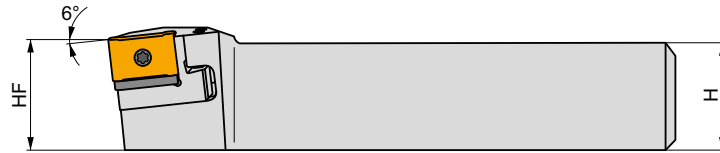
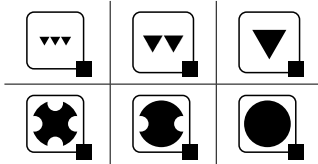
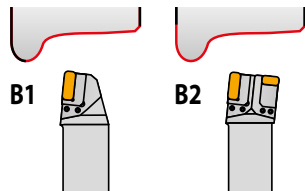

Product	H (mm)	B (mm)	LF (mm)	HF (mm)	WF (mm)	LAMS (°)	GAMO (°)	kg		
R DKTR 5050 X B1*	50	49.50	261	50	47	-6	-6	4.00	G189	DKT
DKTR 5050 X B2*	50	49.50	261	50	55	-6	-6	4.00	G1391	DKT
L DKTL 5050 X B1*	50	49.50	261	50	47	-6	-6	4.00	G188	DKT
DKTL 5050 X B2*	50	49.50	261	50	55	-6	-6	4.00	G1390	DKT

G188	KTP-LANL 19	KTP-LANL 30	KTP-SANL 19	KTP-CANL 19xx	-	-	-	-
G189	KTP-LANR 19	KTP-LANR 30	KTP-SANR 19	KTP-CANR 19xx	-	-	-	-
G1390	KTP-LANL 19	KTP-LANL 30	KTP-SANL 19	KTP-CANL 19xx	KTP-LFNr 19	KTP-SFNr 19	KTP-CFNr 19	
G1391	KTP-LANR 19	KTP-LANR 30	KTP-SANR 19	KTP-CANR 19xx	KTP-LFNr 19	KTP-SFNr 19	KTP-CFNr 19	

DKT	USS 0617	HXK 3

* Special items



DKT(RL)-C



Basic R/L handed tool shank for KTP cartridge heads.

Suited for railway wheels returning. Available in shank size 55x55 mm and 55x52 mm. Suited for Rafamet UBB 112/2 machine tools. Body treated for longer tool life.

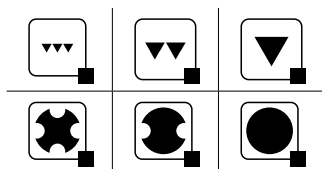
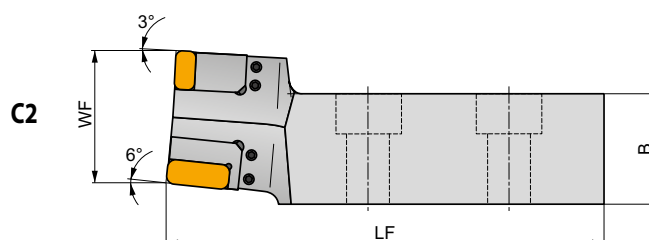
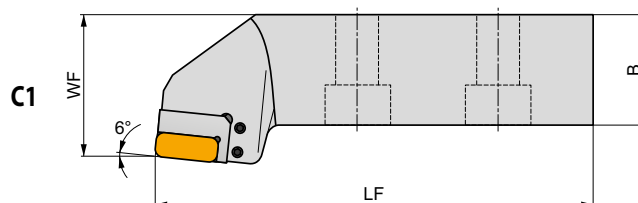
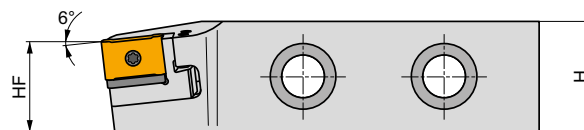
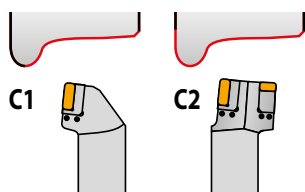

Product	H	B	LF	HF	WF	LAMS	GAMO	kg		
	(mm)	(mm)	(mm)	(mm)	(mm)	(°)	(°)			
R DKTR 5555 X C1*	55	55	217	44	70.00	-6	-6	4.10	G189	DKT
R DKTR 5555 X C2*	55	55	217	44	65.50	-6	-6	4.10	G1391	DKT
L DKTL 5555 X C1*	55	55	217	44	70.00	-6	-6	4.10	G188	DKT
L DKTL 5555 X C2*	55	55	217	44	65.50	-6	-6	4.10	G1390	DKT
R S-DKTR5552XC2-000231*	55	52	217	44	65.50	-6	-6	7.30	G1391	DKT
R S-DKTR5555XC2-000474*	55	55	217	44	70.00	-6	-6	7.70	G1391	DKT
L S-DKTL5552XC2-000230*	55	52	217	44	65.50	-6	-6	7.30	G1390	DKT
L S-DKTL5555XC2-000475*	55	55	217	44	70.00	-6	-6	7.70	G1390	DKT

G188	KTP-LANL 19	KTP-LANL 30	KTP-SANL 19	KTP-CANL 19xx	-	-	-	-
G189	KTP-LANR 19	KTP-LANR 30	KTP-SANR 19	KTP-CANR 19xx	-	-	-	-
G1390	KTP-LANL 19	KTP-LANL 30	KTP-SANL 19	KTP-CANL 19xx	KTP-LFNR 19	KTP-SFNR 19	KTP-CFNR 19	KTP-CFNR 19
G1391	KTP-LANR 19	KTP-LANR 30	KTP-SANR 19	KTP-CANR 19xx	KTP-LFNL 19	KTP-SFNL 19	KTP-CFNL 19	KTP-CFNL 19

DKT	USS 0617	HXK 3

* Special items



DKT(RL)-D



Basic R/L handed tool shank for KTP cartridge heads.

Suited for railway wheels returning. Available in shank size 50x49.5 mm. Suited for Rafamet UBB 112 machine tools. Body treated for longer tool life.

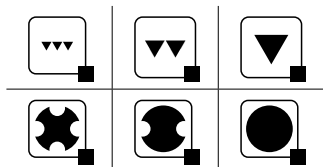
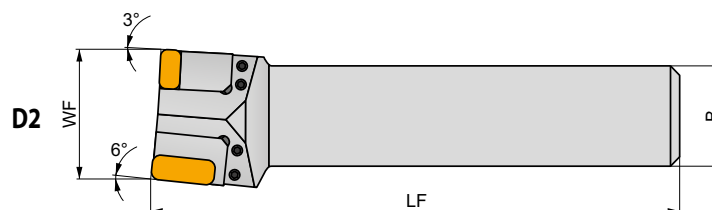
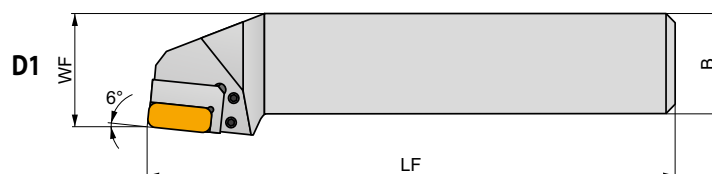
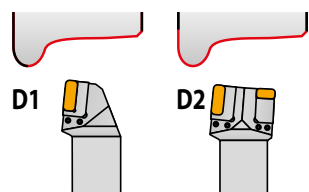

Product	H	B	LF	HF	WF	LAMS	GAMO	kg		
	(mm)	(mm)	(mm)	(mm)	(mm)	(°)	(°)			
R DKTR 5050 X D1*	50	49.5	262	50	55.50	-6	-6	4.20	G189	DKT
DKTR 5050 X D2*	50	49.5	262	50	63.00	-6	-6	4.20	G1391	DKT
L DKTL 5050 X D1*	50	49.5	262	50	55.50	-6	-6	4.20	G188	DKT
DKTL 5050 X D2*	50	49.5	262	50	63.00	-6	-6	4.20	G1390	DKT

G188	KTP-LANL 19	KTP-LANL 30	KTP-SANL 19	KTP-CANL 19xx	-	-	-	-
G189	KTP-LANR 19	KTP-LANR 30	KTP-SANR 19	KTP-CANR 19xx	-	-	-	-
G1390	KTP-LANL 19	KTP-LANL 30	KTP-SANL 19	KTP-CANL 19xx	KTP-LFNR 19	KTP-SFNR 19	KTP-CFNR 19	KTP-CFNR 19
G1391	KTP-LANR 19	KTP-LANR 30	KTP-SANR 19	KTP-CANR 19xx	KTP-LFNL 19	KTP-SFNL 19	KTP-CFNL 19	KTP-CFNL 19

DKT	USS 0617	HXK 3

* Special items



S-DKT(RL)4065X-C



Basic R/L handed tool shank for CNMX 19 inserts clamping.

Suited for renovation of railway wheels. Available in shank size 40x65 mm. Body treated for longer tool life.

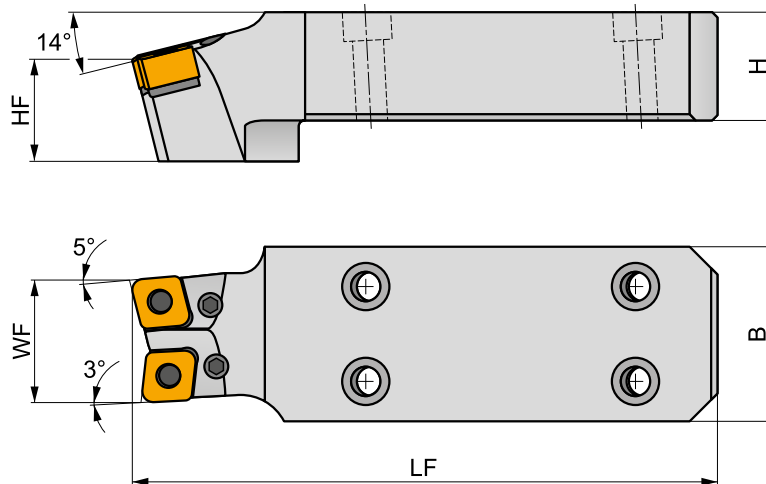
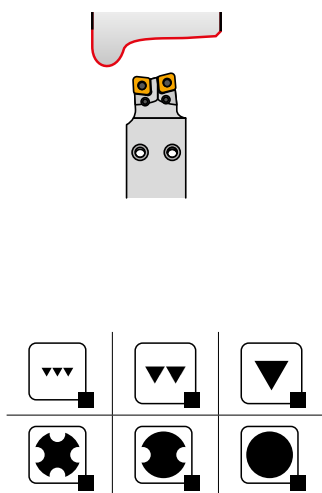

Product	H	B	LF	HF	WF	LAMS	GAMO	kg		
	(mm)	(mm)	(mm)	(mm)	(mm)	(°)	(°)			
R S-DKTR4065X-000243*	40	65	205.9	22.75	45.16	-14	-6	3.43	G1042	C1907
S-DKTR4065X-000378*	40	65	217	22	45	-14	-6	3.70	G1062	C1907
S-DKTR4065X-000437*	40	65	205.9	22.75	45.16	-14	-6	3.50	G1062	C1907
L S-DKTL4065X-000247*	40	65	205.9	22.75	45.16	-14	-6	3.43	G1042	C1907
S-DKTL4065X-000379*	40	65	217	22	45	-14	-6	3.70	G1062	C1907
S-DKTL4065X-000438*	40	65	205.9	22.75	45.16	-14	-6	3.50	G1062	C1907

G1042	CN..1907
G1062	CN..1911

C1907	CNX 19X340	PU 05	US 38	8,0	M10x1	29	NT 06	MT 06	HXK 4
C1911	CNX 19X340	PU 16	US 95	10,0	M10x1	30,5	NT 06	MT 06	HXK 4

* Special items



S-DKT(RL)4065X+KTP



Basic R/L handed tool shank for KTP cartridge heads or direct CNMX 19 or SNMX 19 inserts clamping.

Suited for renovation of railway wheels. Available in shank size 40x65 mm. Body treated for longer tool life.

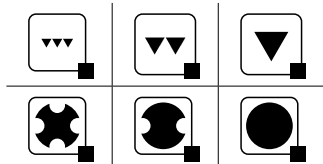
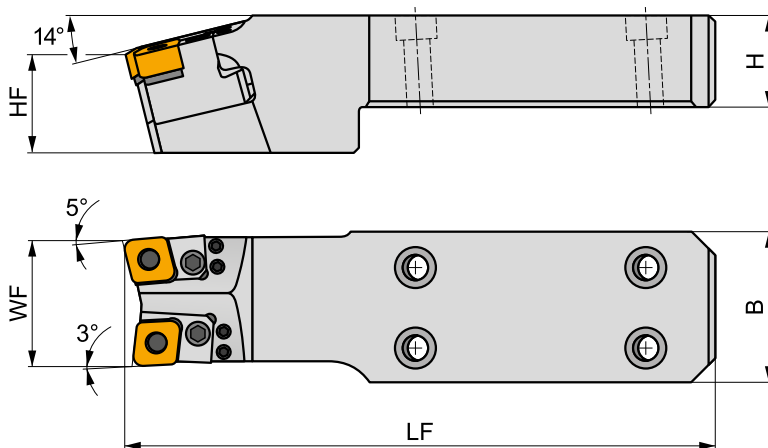
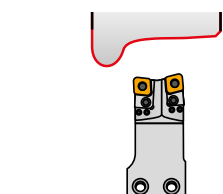

Product	H (mm)	B (mm)	LF (mm)	HF (mm)	WF (mm)	LAMS (°)	GAMO (°)	kg		
R S-DKTR4065X-000435*	40	65	255.9	22.75	54	-14	-6	4.60	GI391	DKT
L S-DKTL4065X-000436*	40	65	255.9	22.75	45.16	-14	-6	3.43	GI390	DKT

GI390	KTP-LANL 19	KTP-LANL 30	KTP-SANL 19	KTP-CANL 19xx	KTP-LFNR 19	KTP-SFNR 19	KTP-CFNR 19
GI391	KTP-LANR 19	KTP-LANR 30	KTP-SANR 19	KTP-CANR 19xx	KTP-LFNL 19	KTP-SFNL 19	KTP-CFNL 19

DKT	USS 0617	HXK 3

* Special items



S-DKT(RL)5556



Basic R/L handed tool shank for KTP cartridge heads.

Suited for renovation of railway wheels. Available in shank size 56x55 mm. Body treated for longer tool life.

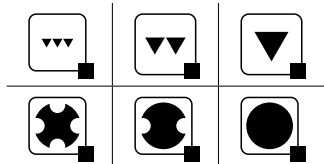
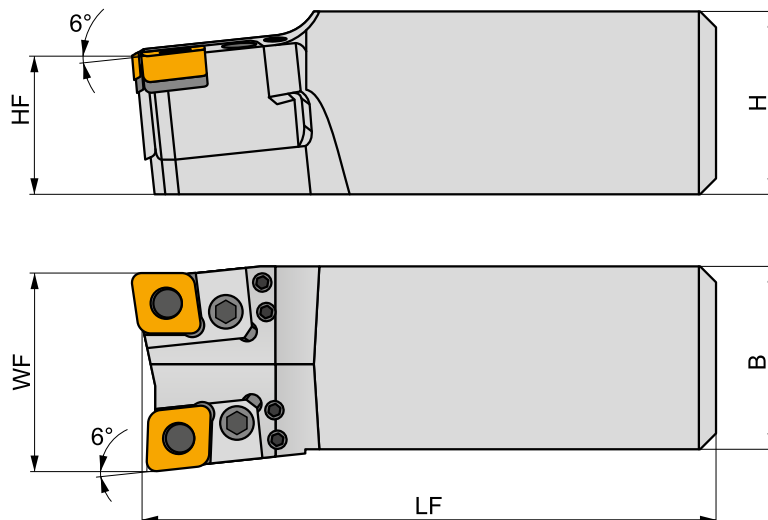
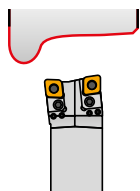

Product	H	B	LF	HF	WF	LAMS	GAMO	kg		
	(mm)	(mm)	(mm)	(mm)	(mm)	(°)	(°)			
R S-DKTR5556-000381*	56	55	176	42.3	55.5	-6	-6	3.40	G1391	DKT
L S-DKTL5556-000382*	56	55	176	42.3	55.5	-6	-6	3.40	G1390	DKT

G1390	KTP-LANL 19	KTP-LANL 30	KTP-LANR 30	KTP-SANL 19	KTP-SANR 19	KTP-CANL 19xx	KTP-CANR 19xx	KTP-LFNR 19	KTP-LFNL 19	KTP-SFNR 19	KTP-SFNL 19	KTP-CFNR 19	KTP-CFNL 19
G1391	KTP-LANR 19	KTP-LANR 30	KTP-LANR 30	KTP-SANR 19	KTP-SANR 19	KTP-CANR 19xx	KTP-CANR 19xx	KTP-LFNR 19	KTP-LFNL 19	KTP-SFNR 19	KTP-SFNL 19	KTP-CFNR 19	KTP-CFNL 19

DKT	USS 0617	HXK 3

* Special items



KTP-CAN(RL)



PRAMET

P



Cartridge for CNMX 19 inserts for railway wheel returning

Lever lock type R/L handed turning cartridge for negative CNMX 19 insert. For mounting on DKT tool holder. Suited for renovation of railway wheels. Tool holder treated for longer tool life.

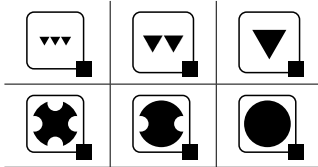
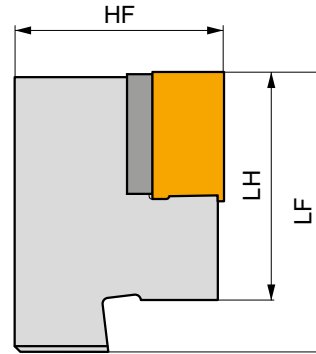
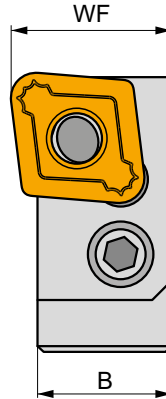
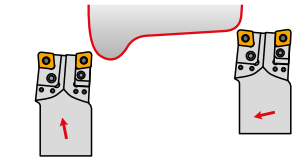

Product	HF	B	WF	LF	HF	kg		
	(mm)	(mm)	(mm)	(mm)	(mm)			
R KTP-CANR 1907	32	20.5	23	43	35	0.16	GI275	C1907
KTP-CANR 1911	32	20.5	23	43	35	0.15	GI277	C1911
KTP-CANR 1906-217	32.15	22.3	25.1	48.7	35	0.15	GI042	C1907
KTP-CANR 1906-219	32.15	26.45	29	48.7	35	0.19	GI042	C1907
L KTP-CANL 1907	32	20.5	23	43	35	0.16	GI275	C1907
KTP-CANL 1911	32	20.5	23	43	35	0.15	GI277	C1911
KTP-CANL 1906-218	32.15	22.3	25.1	48.7	35	0.15	GI042	C1907
KTP-CANL 1906-220	32.15	26.45	29	48.7	35	0.19	GI042	C1907

GI275	CNMX 1907..
GI277	CNMX 1911..
GI042	CN..1907

C1907	CNX 19X340	PU 05	US 38	8.0	M 10x1	29	NT 06	MT 06	HXK 4
C1911	CNX 19X340	PU 16	US 95	10.0	M 10x1	30.5	NT 06	MT 06	HXK 4



KTP-CFN(RL)



PRAMET

P



Cartridge for CNMX 19 inserts for railway wheel returning

Lever lock type R/L handed turning cartridge for negative CNMX 19 insert. For mounting on DKT tool holder. Suited for renovation of railway wheels. Tool holder treated for longer tool life.

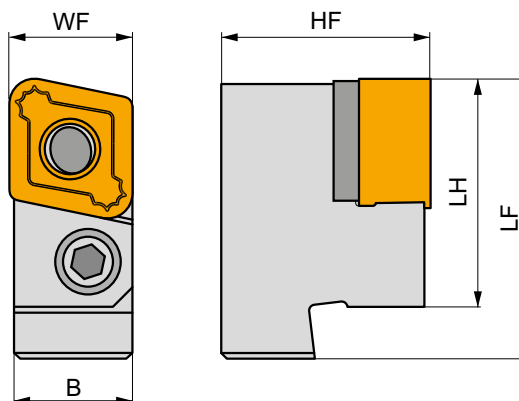
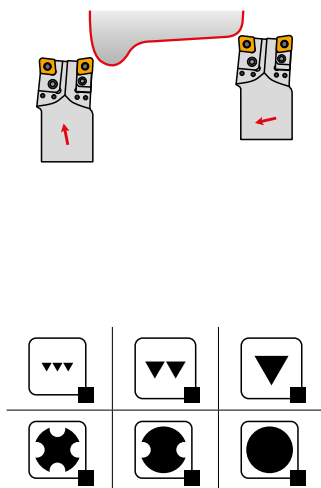

Product	HF (mm)	B (mm)	WF (mm)	LF (mm)	LH (mm)	kg		
R KTP-CFNR 1907	32	18.25	19.05	43	35	0.15	GI275	C1907
KTP-CFNR 1911	32	18.25	19.05	43	35	0.14	GI277	C1911
L KTP-CFNL 1907	32	18.25	19.05	43	35	0.15	GI275	C1907
KTP-CFNL 1911	32	18.25	19.05	43	35	0.14	GI277	C1911

GI275	CNMX 1907..
GI277	CNMX 1911..

C1907	CNX 19X340	PU 05	US 38	8.0	M 10x1	29	NT 06	MT 06	HXK 4
C1911	CNX 19X340	PU 16	US 95	10.0	M 10x1	30.5	NT 06	MT 06	HXK 4



DN

11/ 15

CARBIDE INSERTS

DNMG



170

DNMM



177

MATCH THE RIGHT SIZE (example)

Insert

DNMG 150404E-SF

Tool Holder

DDJNL 2020 K 15

DDJN(RL) EXT

93°

DN..

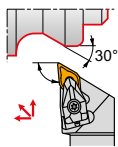
11
15
 20×20
32×32

178

170 – 177

PDJN(RL) EXT

93°

DN..

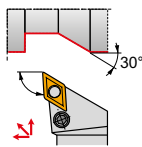
11
15
 20×20
32×32

179

170 – 177

PDNN(RL) EXT

62°30'

DN..

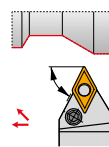
11
15
 20×20
32×25

180

170 – 177

C.-DDJN(RL) EXT

93°

DN..

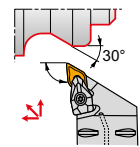
11
15
 C4
C6

181

170 – 177

C.-DDNNN EXT

62.5°

DN..

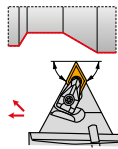

15

 C5
C6

182

170 – 177



DNMG

	IC	D1	L	S
	(mm)	(mm)	(mm)	(mm)
1104	9.525	3.81	11.60	4.76
1504	12.700	5.16	15.50	4.76
1506	12.700	5.16	15.50	6.35

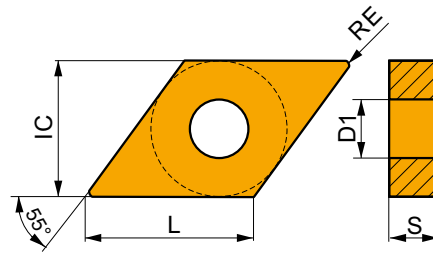

Suitability and starting values for cutting speed (vc), feed (f) and depth of cut (ap). Refer to our Machining Calculator app for further calculations.

Product	RE	P			M			K			N			S			H		
		vc	f	ap	vc	f	ap	vc	f	ap	vc	f	ap	vc	f	ap	vc	f	ap
	(mm)	(m/min)	(mm/rev)	(mm)	(m/min)	(mm/rev)	(mm)	(m/min)	(mm/rev)	(mm)	(m/min)	(mm/rev)	(mm)	(m/min)	(mm/rev)	(mm)	(m/min)	(mm/rev)	(mm)

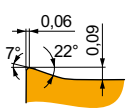

FF geometry with highly positive design for fine-finish machining and continuous to slightly interrupted cuts.

DNMG 110402E-FF	T8315	0.2	✔ 175	0.10	0.8	✘ 105	0.09	0.8	✔ 165	0.10	0.8	–	–	–	–	–	–	–	–	–
DNMG 110404E-FF	T8315	0.4	✔ 175	0.12	0.8	✘ 105	0.11	0.8	✔ 165	0.12	0.8	–	–	–	–	–	–	–	–	–
	T8430	0.4	✔ 205	0.12	0.8	✘ 110	0.11	0.8	✔ 170	0.12	0.8	–	–	–	–	–	–	–	–	–
DNMG 110408E-FF	T8315	0.8	✔ 200	0.15	0.8	✘ 120	0.14	0.8	✔ 190	0.15	0.8	–	–	–	–	–	–	–	–	–
DNMG 150404E-FF	T8315	0.4	✔ 175	0.12	1.0	✘ 105	0.11	1.0	✔ 165	0.12	1.0	–	–	–	–	–	–	–	–	–
DNMG 150604E-FF	T8315	0.4	✔ 175	0.12	1.0	✘ 105	0.11	1.0	✔ 165	0.12	1.0	–	–	–	–	–	–	–	–	–
DNMG 150608E-FF	T7325	0.8	✔ 210	0.15	1.0	✘ 160	0.14	1.0	–	–	–	–	–	–	–	–	–	–	–	–
	T8315	0.8	✔ 195	0.15	1.0	✘ 115	0.14	1.0	✔ 185	0.15	1.0	–	–	–	–	–	–	–	–	–

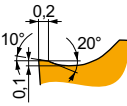

FM geometry with positive design for finish to semi-rough machining, and continuous to slightly interrupted cuts.

DNMG 110404E-FM	T8315	0.4	✔ 150	0.20	0.8	✔ 90	0.18	0.8	✘ 140	0.20	0.8	–	–	–	✔ 35	0.14	0.6	–	–	–
	T8430	0.4	✔ 165	0.20	0.8	✔ 90	0.18	0.8	✔ 135	0.20	0.8	–	–	–	✔ 35	0.14	0.6	–	–	–
	T9310	0.4	✔ 245	0.20	0.8	–	–	–	✔ 230	0.20	0.8	–	–	–	–	–	–	–	–	–
	T9315	0.4	✔ 225	0.20	0.8	–	–	–	✔ 210	0.20	0.8	–	–	–	–	–	–	–	–	–
	T9325	0.4	✔ 200	0.20	0.8	✔ 120	0.18	0.8	✔ 190	0.20	0.8	–	–	–	✔ 45	0.20	0.6	–	–	–
DNMG 110408E-FM	T7325	0.8	✔ 200	0.20	0.8	✔ 155	0.18	0.8	–	–	–	–	–	–	✔ 65	0.16	0.6	–	–	–
	T8315	0.8	✔ 180	0.20	0.8	✔ 105	0.18	0.8	✘ 170	0.20	0.8	–	–	–	✔ 45	0.14	0.6	–	–	–
	T8430	0.8	✔ 195	0.20	0.8	✔ 105	0.18	0.8	✔ 160	0.20	0.8	–	–	–	✔ 40	0.14	0.6	–	–	–
	T9310	0.8	✔ 295	0.20	0.8	–	–	–	✔ 280	0.20	0.8	–	–	–	–	–	–	–	–	–
	T9315	0.8	✔ 270	0.20	0.8	–	–	–	✔ 255	0.20	0.8	–	–	–	–	–	–	–	–	–
	T9325	0.8	✔ 240	0.20	0.8	✔ 140	0.18	0.8	✔ 225	0.20	0.8	–	–	–	✔ 50	0.16	0.6	–	–	–
DNMG 150404E-FM	T7325	0.4	✔ 150	0.20	1.7	✔ 115	0.18	1.7	–	–	–	–	–	–	✔ 45	0.20	1.4	–	–	–
	T8430	0.4	✔ 150	0.20	1.7	✔ 80	0.18	1.7	✔ 125	0.20	1.7	–	–	–	✔ 30	0.14	1.4	–	–	–
	T9315	0.4	✔ 210	0.20	1.7	–	–	–	✔ 195	0.20	1.7	–	–	–	–	–	–	–	–	–
	T9325	0.4	✔ 190	0.20	1.7	✔ 110	0.18	1.7	✔ 180	0.20	1.7	–	–	–	✔ 40	0.20	1.4	–	–	–
DNMG 150408E-FM	T7325	0.8	✔ 180	0.20	1.7	✔ 140	0.18	1.7	–	–	–	–	–	–	✔ 55	0.16	1.4	–	–	–
	T8430	0.8	✔ 185	0.20	1.7	✔ 100	0.18	1.7	✔ 150	0.20	1.7	–	–	–	✔ 40	0.16	1.4	–	–	–
	T9315	0.8	✔ 250	0.20	1.7	–	–	–	✔ 235	0.20	1.7	–	–	–	–	–	–	–	–	–
	T9325	0.8	✔ 225	0.20	1.7	✔ 135	0.18	1.7	✔ 210	0.20	1.7	–	–	–	✔ 50	0.16	1.4	–	–	–
DNMG 150604E-FM	T7325	0.4	✔ 150	0.20	1.7	✔ 115	0.18	1.7	–	–	–	–	–	–	✔ 45	0.20	1.4	–	–	–
	T7335	0.4	✔ 150	0.20	1.7	✔ 115	0.18	1.7	–	–	–	–	–	–	✔ 45	0.20	1.4	–	–	–
	T8315	0.4	✔ 140	0.20	1.7	✔ 80	0.18	1.7	✘ 130	0.20	1.7	–	–	–	✔ 35	0.14	1.4	–	–	–
	T8430	0.4	✔ 150	0.20	1.7	✔ 80	0.18	1.7	✔ 125	0.20	1.7	–	–	–	✔ 30	0.14	1.4	–	–	–
	T9310	0.4	✔ 230	0.20	1.7	–	–	–	✔ 215	0.20	1.7	–	–	–	–	–	–	–	–	–
	T9315	0.4	✔ 210	0.20	1.7	–	–	–	✔ 195	0.20	1.7	–	–	–	–	–	–	–	–	–
	T9325	0.4	✔ 190	0.20	1.7	✔ 110	0.18	1.7	✔ 180	0.20	1.7	–	–	–	✔ 40	0.20	1.4	–	–	–
	TT310	0.4	✔ 210	0.20	1.7	✔ 125	0.18	1.7	–	–	–	–	–	–	–	–	–	–	–	–



Suitability and starting values for cutting speed (vc), feed (f) and depth of cut (ap). Refer to our Machining Calculator app for further calculations.

Product	RE (mm)	P			M			K			N			S			H		
		vc (m/min)	f (mm/rev)	ap (mm)	vc (m/min)	f (mm/rev)	ap (mm)	vc (m/min)	f (mm/rev)	ap (mm)	vc (m/min)	f (mm/rev)	ap (mm)	vc (m/min)	f (mm/rev)	ap (mm)	vc (m/min)	f (mm/rev)	ap (mm)

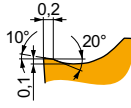

FM geometry with positive design for finish to semi-rough machining, and continuous to slightly interrupted cuts.

DNMG 150608E-FM	T7325	0.8	180	0.20	1.7	140	0.18	1.7	—	—	—	—	—	—	55	0.16	1.4	—	—	—	
	T7335	0.8	175	0.20	1.7	135	0.18	1.7	—	—	—	—	—	—	55	0.16	1.4	—	—	—	
	T8315	0.8	170	0.20	1.7	100	0.18	1.7	160	0.20	1.7	—	—	—	40	0.16	1.4	—	—	—	
	T8430	0.8	185	0.20	1.7	100	0.18	1.7	150	0.20	1.7	—	—	—	40	0.16	1.4	—	—	—	
	T9310	0.8	275	0.20	1.7	—	—	—	260	0.20	1.7	—	—	—	—	—	—	—	—	—	—
	T9315	0.8	250	0.20	1.7	—	—	—	235	0.20	1.7	—	—	—	—	—	—	—	—	—	—
DNMG 150612E-FM	T7325	1.2	180	0.25	1.7	140	0.23	1.7	—	—	—	—	—	—	55	0.18	1.4	—	—	—	
	T8430	1.2	175	0.25	1.7	95	0.23	1.7	140	0.25	1.7	—	—	—	35	0.18	1.4	—	—	—	
	T9310	1.2	260	0.25	1.7	—	—	—	245	0.25	1.7	—	—	—	—	—	—	—	—	—	
	T9315	1.2	240	0.25	1.7	—	—	—	225	0.25	1.7	—	—	—	—	—	—	—	—	—	
	T9325	1.2	215	0.25	1.7	125	0.23	1.7	200	0.25	1.7	—	—	—	45	0.18	1.4	—	—	—	
DNMG 150616E-FM	T9315	1.6	235	0.30	1.7	—	—	—	220	0.30	1.7	—	—	—	—	—	—	—	—	—	
	T9325	1.6	210	0.30	1.7	125	0.27	1.7	195	0.30	1.7	—	—	—	45	0.21	1.4	—	—	—	

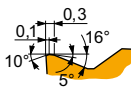

M geometry for finish to semi-rough machining, and continuous to interrupted cuts.

DNMG 110404E-M	T5315	0.4	210	0.20	1.2	—	—	—	195	0.20	1.2	—	—	—	—	—	—	40	0.14	0.3
	T9315	0.4	195	0.20	1.2	—	—	—	185	0.20	1.2	—	—	—	—	—	—	35	0.14	0.3
	T9325	0.4	175	0.20	1.2	—	—	—	165	0.20	1.2	—	—	—	—	—	—	—	—	—
	T9335	0.4	150	0.20	1.2	—	—	—	—	—	—	—	—	—	—	—	—	—	—	—
DNMG 110408E-M	T5315	0.8	215	0.30	1.2	—	—	—	200	0.30	1.2	—	—	—	—	—	—	40	0.15	0.7
	T9315	0.8	200	0.30	1.2	—	—	—	190	0.30	1.2	—	—	—	—	—	—	40	0.15	0.7
	T9325	0.8	175	0.30	1.2	—	—	—	165	0.30	1.2	—	—	—	—	—	—	—	—	—
	T9335	0.8	155	0.30	1.2	—	—	—	—	—	—	—	—	—	—	—	—	—	—	—
DNMG 110412E-M	T9315	1.2	185	0.40	1.2	—	—	—	175	0.40	1.2	—	—	—	—	—	—	35	0.20	0.9
	T9325	1.2	165	0.40	1.2	—	—	—	155	0.40	1.2	—	—	—	—	—	—	—	—	—
	T9335	1.2	140	0.40	1.2	—	—	—	—	—	—	—	—	—	—	—	—	—	—	—
DNMG 150404E-M	T5315	0.4	200	0.20	1.9	—	—	—	190	0.20	1.9	—	—	—	—	—	—	40	0.14	0.3
	T9315	0.4	190	0.20	1.9	—	—	—	180	0.20	1.9	—	—	—	—	—	—	35	0.14	0.3
	T9325	0.4	170	0.20	1.9	—	—	—	160	0.20	1.9	—	—	—	—	—	—	—	—	—
	T9335	0.4	145	0.20	1.9	—	—	—	—	—	—	—	—	—	—	—	—	—	—	—
DNMG 150408E-M	T5315	0.8	205	0.30	1.9	—	—	—	190	0.30	1.9	—	—	—	—	—	—	40	0.15	0.7
	T9315	0.8	190	0.30	1.9	—	—	—	180	0.30	1.9	—	—	—	—	—	—	35	0.15	0.7
	T9325	0.8	170	0.30	1.9	—	—	—	160	0.30	1.9	—	—	—	—	—	—	—	—	—
	T9335	0.8	145	0.30	1.9	—	—	—	—	—	—	—	—	—	—	—	—	—	—	—
DNMG 150412E-M	T5315	1.2	200	0.40	1.9	—	—	—	190	0.40	1.9	—	—	—	—	—	—	40	0.20	0.9
	T9315	1.2	175	0.40	1.9	—	—	—	165	0.40	1.9	—	—	—	—	—	—	35	0.20	0.9
	T9325	1.2	160	0.40	1.9	—	—	—	150	0.40	1.9	—	—	—	—	—	—	—	—	—
DNMG 150604E-M	T5315	0.4	200	0.20	1.9	—	—	—	190	0.20	1.9	—	—	—	—	—	—	40	0.14	0.3
	T9315	0.4	190	0.20	1.9	—	—	—	180	0.20	1.9	—	—	—	—	—	—	35	0.14	0.3
	T9325	0.4	170	0.20	1.9	—	—	—	160	0.20	1.9	—	—	—	—	—	—	—	—	—
	T9335	0.4	145	0.20	1.9	—	—	—	—	—	—	—	—	—	—	—	—	—	—	—
DNMG 150608E-M	T5315	0.8	205	0.30	1.9	—	—	—	190	0.30	1.9	—	—	—	—	—	—	40	0.15	0.7
	T9310	0.8	205	0.30	1.9	—	—	—	190	0.30	1.9	—	—	—	—	—	—	40	0.15	0.7
	T9315	0.8	190	0.30	1.9	—	—	—	180	0.30	1.9	—	—	—	—	—	—	35	0.15	0.7
	T9325	0.8	170	0.30	1.9	—	—	—	160	0.30	1.9	—	—	—	—	—	—	—	—	—
	T9335	0.8	145	0.30	1.9	—	—	—	—	—	—	—	—	—	—	—	—	—	—	—
DNMG 150612E-M	T5315	1.2	200	0.40	1.9	—	—	—	190	0.40	1.9	—	—	—	—	—	—	40	0.20	0.9
	T9310	1.2	190	0.40	1.9	—	—	—	180	0.40	1.9	—	—	—	—	—	—	35	0.20	0.9
	T9315	1.2	175	0.40	1.9	—	—	—	165	0.40	1.9	—	—	—	—	—	—	35	0.20	0.9
	T9325	1.2	160	0.40	1.9	—	—	—	150	0.40	1.9	—	—	—	—	—	—	—	—	—
	T9335	1.2	140	0.40	1.9	—	—	—	—	—	—	—	—	—	—	—	—	—	—	—
	T9335	1.2	140	0.40	1.9	—	—	—	—	—	—	—	—	—	—	—	—	—	—	—



Suitability and starting values for cutting speed (vc), feed (f) and depth of cut (ap). Refer to our Machining Calculator app for further calculations.

Product	RE (mm)	P			M			K			N			S			H		
		vc (m/min)	f (mm/rev)	ap (mm)	vc (m/min)	f (mm/rev)	ap (mm)	vc (m/min)	f (mm/rev)	ap (mm)	vc (m/min)	f (mm/rev)	ap (mm)	vc (m/min)	f (mm/rev)	ap (mm)	vc (m/min)	f (mm/rev)	ap (mm)

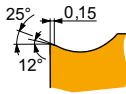

NF geometry with highly positive design for fine-finish to medium machining, and continuous cuts.

DNMG 110404E-NF	T6310	0.4	155	0.15	0.8	110	0.14	0.8	125	0.15	0.8	465	0.18	0.8	45	0.12	0.6	-	-	-
	T7325	0.4	170	0.18	0.8	130	0.16	0.8	-	-	-	-	-	-	55	0.16	0.6	-	-	-
	T7335	0.4	165	0.18	0.8	125	0.16	0.8	-	-	-	-	-	-	50	0.16	0.6	-	-	-
	T8430	0.4	190	0.15	0.8	105	0.14	0.8	155	0.15	0.8	525	0.18	0.8	40	0.12	0.6	-	-	-
	T9325	0.4	210	0.18	0.8	125	0.16	0.8	195	0.18	0.8	-	-	-	45	0.16	0.6	-	-	-
DNMG 110408E-NF	T6310	0.8	175	0.17	1.0	125	0.15	1.0	140	0.17	1.0	525	0.20	1.0	50	0.14	0.8	-	-	-
	T7325	0.8	200	0.18	1.0	155	0.16	1.0	-	-	-	-	-	65	0.16	0.8	-	-	-	
	T7335	0.8	195	0.18	1.0	150	0.16	1.0	-	-	-	-	-	60	0.16	0.8	-	-	-	
	T8430	0.8	205	0.17	1.0	110	0.15	1.0	170	0.17	1.0	570	0.20	1.0	45	0.14	0.8	-	-	-
	T9315	0.8	280	0.17	1.0	-	-	-	265	0.17	1.0	-	-	-	-	-	-	-	-	-
DNMG 150404E-NF	T6310	0.4	140	0.17	1.7	100	0.15	1.7	110	0.17	1.7	420	0.20	1.7	40	0.15	1.4	-	-	-
	T7325	0.4	160	0.18	1.7	120	0.16	1.7	-	-	-	-	-	50	0.16	1.4	-	-	-	
	T7335	0.4	155	0.18	1.7	120	0.16	1.7	-	-	-	-	-	50	0.16	1.4	-	-	-	
	T8430	0.4	165	0.17	1.7	90	0.15	1.7	135	0.17	1.7	450	0.20	1.7	35	0.15	1.4	-	-	-
	T9315	0.4	235	0.15	1.7	-	-	-	220	0.15	1.7	-	-	-	-	-	-	-	-	-
DNMG 150408E-NF	T6310	0.8	165	0.18	1.7	115	0.16	1.7	130	0.18	1.7	495	0.22	1.7	45	0.16	1.4	-	-	-
	T7325	0.8	190	0.18	1.7	145	0.16	1.7	-	-	-	-	-	60	0.16	1.4	-	-	-	
	T7335	0.8	185	0.18	1.7	140	0.16	1.7	-	-	-	-	-	60	0.16	1.4	-	-	-	
	T8430	0.8	190	0.18	1.7	105	0.16	1.7	155	0.18	1.7	525	0.22	1.7	40	0.16	1.4	-	-	-
	T9315	0.8	270	0.17	1.7	-	-	-	255	0.17	1.7	-	-	-	-	-	-	-	-	-
DNMG 150604E-NF	HF7	0.4	-	-	-	80	0.14	1.9	130	0.15	1.9	420	0.18	1.9	-	-	-	-	-	-
	T6310	0.4	140	0.17	1.9	100	0.15	1.9	110	0.17	1.9	420	0.20	1.9	40	0.15	1.5	-	-	-
	T7325	0.4	155	0.18	1.9	120	0.16	1.9	-	-	-	-	-	50	0.16	1.5	-	-	-	
	T7335	0.4	150	0.18	1.9	115	0.16	1.9	-	-	-	-	-	45	0.16	1.5	-	-	-	
	T8315	0.4	145	0.17	1.9	85	0.15	1.9	135	0.17	1.9	435	0.20	1.9	35	0.15	1.5	-	-	-
	T8430	0.4	165	0.17	1.9	90	0.15	1.9	135	0.17	1.9	450	0.20	1.9	35	0.15	1.5	-	-	-
	T9315	0.4	235	0.15	1.9	-	-	-	220	0.15	1.9	-	-	-	-	-	-	-	-	-
	T9325	0.4	195	0.18	1.9	115	0.16	1.9	185	0.18	1.9	-	-	-	40	0.16	1.5	-	-	-
DNMG 150608E-NF	HF7	0.8	-	-	-	90	0.15	1.9	145	0.17	1.9	465	0.20	1.9	-	-	-	-	-	-
	T6310	0.8	165	0.18	1.9	115	0.16	1.9	130	0.18	1.9	495	0.22	1.9	45	0.16	1.5	-	-	-
	T7325	0.8	185	0.18	1.9	140	0.16	1.9	-	-	-	-	-	60	0.16	1.5	-	-	-	
	T7335	0.8	180	0.18	1.9	140	0.16	1.9	-	-	-	-	-	55	0.16	1.5	-	-	-	
	T8315	0.8	175	0.18	1.9	105	0.16	1.9	165	0.18	1.9	525	0.22	1.9	40	0.16	1.5	-	-	-
	T8430	0.8	190	0.18	1.9	105	0.16	1.9	155	0.18	1.9	525	0.22	1.9	40	0.16	1.5	-	-	-
	T9315	0.8	265	0.17	1.9	-	-	-	250	0.17	1.9	-	-	-	-	-	-	-	-	-
	T9325	0.8	230	0.18	1.9	135	0.16	1.9	215	0.18	1.9	-	-	-	50	0.16	1.5	-	-	-
DNMG 150612E-NF	T6310	1.2	150	0.30	1.5	105	0.27	1.5	120	0.30	1.5	450	0.36	1.5	45	0.21	1.2	-	-	-
	T8430	1.2	165	0.30	1.5	90	0.27	1.5	135	0.30	1.5	450	0.36	1.5	35	0.21	1.2	-	-	-

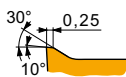

NM geometry with highly positive design for fine-finish, medium to rough machining, and continuous cuts.

DNMG 110404E-NM	T7325	0.4	175	0.20	0.8	135	0.18	0.8	-	-	-	-	-	55	0.20	0.6	-	-	-	
	T7335	0.4	165	0.20	0.8	125	0.18	0.8	-	-	-	-	-	50	0.20	0.6	-	-	-	
	T8430	0.4	175	0.20	0.8	95	0.18	0.8	-	-	-	480	0.24	0.8	35	0.20	0.6	-	-	-
	T9325	0.4	210	0.20	0.8	125	0.18	0.8	-	-	-	-	-	45	0.20	0.6	-	-	-	
DNMG 110408E-NM	T7325	0.8	190	0.25	0.8	145	0.23	0.8	-	-	-	-	-	60	0.20	0.6	-	-	-	
	T7335	0.8	185	0.25	0.8	140	0.23	0.8	-	-	-	-	-	60	0.20	0.6	-	-	-	
	T8315	0.8	180	0.25	0.8	105	0.23	0.8	-	-	-	540	0.30	0.8	45	0.20	0.6	-	-	-
	T8430	0.8	190	0.25	0.8	105	0.23	0.8	-	-	-	525	0.30	0.8	40	0.20	0.6	-	-	-
	T9325	0.8	230	0.25	0.8	135	0.23	0.8	-	-	-	-	-	50	0.20	0.6	-	-	-	
DNMG 150408E-NM	T8430	0.8	175	0.25	1.9	95	0.23	1.9	-	-	-	480	0.30	1.9	35	0.20	1.5	-	-	-
	T9325	0.8	210	0.25	1.9	125	0.23	1.9	-	-	-	-	-	45	0.20	1.5	-	-	-	



Suitability and starting values for cutting speed (vc), feed (f) and depth of cut (ap). Refer to our Machining Calculator app for further calculations.

Product	RE (mm)	P			M			K			N			S			H		
		vc (m/min)	f (mm/rev)	ap (mm)	vc (m/min)	f (mm/rev)	ap (mm)	vc (m/min)	f (mm/rev)	ap (mm)	vc (m/min)	f (mm/rev)	ap (mm)	vc (m/min)	f (mm/rev)	ap (mm)	vc (m/min)	f (mm/rev)	ap (mm)

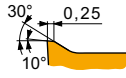

NM geometry with highly positive design for fine-finish, medium to rough machining, and continuous cuts.

DNMG 150604E-NM	T7325	0.4	160	0.20	1.9	120	0.18	1.9	-	-	-	-	-	-	50	0.20	1.5	-	-	-
	T7335	0.4	150	0.20	1.9	115	0.18	1.9	-	-	-	-	-	-	45	0.20	1.5	-	-	-
	T8315	0.4	150	0.20	1.9	90	0.18	1.9	-	-	-	450	0.24	1.9	35	0.20	1.5	-	-	-
	T8430	0.4	155	0.20	1.9	85	0.18	1.9	-	-	-	435	0.24	1.9	30	0.20	1.5	-	-	-
	T9325	0.4	195	0.20	1.9	115	0.18	1.9	-	-	-	-	-	-	40	0.20	1.5	-	-	-
DNMG 150608E-NM	T7325	0.8	175	0.25	1.9	135	0.23	1.9	-	-	-	-	-	-	55	0.20	1.5	-	-	-
	T7335	0.8	170	0.25	1.9	130	0.23	1.9	-	-	-	-	-	-	55	0.20	1.5	-	-	-
	T8315	0.8	165	0.25	1.9	95	0.23	1.9	-	-	-	495	0.30	1.9	40	0.20	1.5	-	-	-
	T8430	0.8	175	0.25	1.9	95	0.23	1.9	-	-	-	480	0.30	1.9	35	0.20	1.5	-	-	-
	T9315	0.8	235	0.25	1.9	-	-	-	-	-	-	-	-	-	-	-	-	-	-	-
DNMG 150612E-NM	T7325	1.2	175	0.30	1.9	135	0.27	1.9	-	-	-	-	-	-	45	0.20	1.5	-	-	-
	T7335	1.2	170	0.30	1.9	130	0.27	1.9	-	-	-	-	-	-	55	0.24	1.5	-	-	-
	T9325	1.2	205	0.30	1.9	120	0.27	1.9	-	-	-	-	-	-	45	0.24	1.5	-	-	-

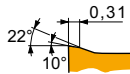

NMR geometry with positive design for medium to rough machining, and continuous cuts.

DNMG 110404E-NMR	T7325	0.4	150	0.20	0.8	115	0.18	0.8	-	-	-	-	-	-	45	0.18	0.6	-	-	-
	T9315	0.4	205	0.20	0.8	-	-	-	-	-	-	-	-	-	-	-	-	-	-	-
	T9325	0.4	185	0.20	0.8	110	0.18	0.8	-	-	-	-	-	-	40	0.18	0.6	-	-	-
DNMG 110408E-NMR	T7325	0.8	155	0.30	0.8	120	0.27	0.8	-	-	-	-	-	-	50	0.24	0.6	-	-	-
	T9315	0.8	205	0.30	0.8	-	-	-	-	-	-	-	-	-	-	-	-	-	-	-
DNMG 110412E-NMR	T7325	1.2	155	0.30	1.6	120	0.27	1.6	-	-	-	-	-	-	50	0.24	1.3	-	-	-
	T9325	1.2	180	0.30	1.6	105	0.27	1.6	-	-	-	-	-	-	40	0.24	1.3	-	-	-
DNMG 150404E-NMR	T7325	0.4	140	0.20	1.9	105	0.18	1.9	-	-	-	-	-	-	45	0.18	1.5	-	-	-
	T9325	0.4	170	0.20	1.9	100	0.18	1.9	-	-	-	-	-	-	35	0.18	1.5	-	-	-
DNMG 150408E-NMR	T7325	0.8	145	0.30	1.9	110	0.27	1.9	-	-	-	-	-	-	45	0.24	1.5	-	-	-
	T8430	0.8	135	0.30	1.9	75	0.27	1.9	-	-	-	-	-	-	25	0.24	1.5	-	-	-
	T9315	0.8	190	0.30	1.9	-	-	-	-	-	-	-	-	-	-	-	-	-	-	-
	T9325	0.8	170	0.30	1.9	100	0.27	1.9	-	-	-	-	-	-	35	0.24	1.5	-	-	-
DNMG 150604E-NMR	T7325	0.4	140	0.20	1.9	105	0.18	1.9	-	-	-	-	-	-	45	0.18	1.5	-	-	-
	T7335	0.4	130	0.20	1.9	100	0.18	1.9	-	-	-	-	-	-	40	0.18	1.5	-	-	-
	T8430	0.4	135	0.20	1.9	75	0.18	1.9	-	-	-	-	-	-	25	0.18	1.5	-	-	-
	T9315	0.4	190	0.20	1.9	-	-	-	-	-	-	-	-	-	-	-	-	-	-	-
DNMG 150608E-NMR	T9325	0.4	170	0.20	1.9	100	0.18	1.9	-	-	-	-	-	-	35	0.18	1.5	-	-	-
	T6310	0.8	125	0.30	1.9	90	0.27	1.9	-	-	-	-	-	-	35	0.24	1.5	-	-	-
	T7325	0.8	145	0.30	1.9	110	0.27	1.9	-	-	-	-	-	-	45	0.24	1.5	-	-	-
	T7335	0.8	140	0.30	1.9	105	0.27	1.9	-	-	-	-	-	-	45	0.24	1.5	-	-	-
	T8430	0.8	135	0.30	1.9	75	0.27	1.9	-	-	-	-	-	-	25	0.24	1.5	-	-	-
DNMG 150612E-NMR	T9315	0.8	190	0.30	1.9	-	-	-	-	-	-	-	-	-	-	-	-	-	-	-
	T9325	0.8	170	0.30	1.9	100	0.27	1.9	-	-	-	-	-	-	35	0.24	1.5	-	-	-
	T7325	1.2	155	0.30	1.9	120	0.27	1.9	-	-	-	-	-	-	50	0.24	1.5	-	-	-
	T8430	1.2	145	0.30	1.9	80	0.27	1.9	-	-	-	-	-	-	30	0.24	1.5	-	-	-
	T9315	1.2	200	0.30	1.9	-	-	-	-	-	-	-	-	-	-	-	-	-	-	-
T9325	1.2	180	0.30	1.9	105	0.27	1.9	-	-	-	-	-	-	40	0.24	1.5	-	-	-	

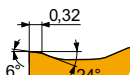

NRM geometry with positive design for semi-rough to rough machining, and continuous to moderate interrupted cuts.

DNMG 150608-NRM	T7335	0.8	130	0.30	3.0	100	0.27	3.0	-	-	-	-	-	-	40	0.24	2.4	-	-	-
	T9315	0.8	180	0.30	3.0	-	-	-	-	-	-	-	-	-	-	-	-	-	-	-



Suitability and starting values for cutting speed (vc), feed (f) and depth of cut (ap). Refer to our Machining Calculator app for further calculations.

Product	RE (mm)	P			M			K			N			S			H		
		vc (m/min)	f (mm/rev)	ap (mm)	vc (m/min)	f (mm/rev)	ap (mm)	vc (m/min)	f (mm/rev)	ap (mm)	vc (m/min)	f (mm/rev)	ap (mm)	vc (m/min)	f (mm/rev)	ap (mm)	vc (m/min)	f (mm/rev)	ap (mm)

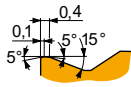

R geometry for semi-rough to rough machining, and continuous to interrupted cuts.

DNMG 150408E-R	T5315	0.8	175	0.40	3.0	-	-	-	165	0.40	3.0	-	-	-	-	-	-	35	0.20	0.7
	T5305	0.8	200	0.40	3.0	-	-	-	190	0.40	3.0	-	-	-	-	-	-	40	0.20	0.7
DNMG 150608E-R	T5315	0.8	175	0.40	3.0	-	-	-	165	0.40	3.0	-	-	-	-	-	-	35	0.20	0.7
	T9310	0.8	170	0.40	3.0	-	-	-	160	0.40	3.0	-	-	-	-	-	-	30	0.20	0.7
DNMG 150612E-R	T9315	0.8	155	0.40	3.0	-	-	-	145	0.40	3.0	-	-	-	-	-	-	30	0.20	0.7
	T9325	0.8	140	0.40	3.0	-	-	-	130	0.40	3.0	-	-	-	-	-	-	-	-	-
	T5315	1.2	185	0.40	3.0	-	-	-	175	0.40	3.0	-	-	-	-	-	-	35	0.20	0.9
	T9310	1.2	180	0.40	3.0	-	-	-	170	0.40	3.0	-	-	-	-	-	-	35	0.20	0.9
	T9315	1.2	165	0.40	3.0	-	-	-	155	0.40	3.0	-	-	-	-	-	-	30	0.20	0.9
DNMG 150616E-R	T9325	1.6	155	0.40	3.0	-	-	-	145	0.40	3.0	-	-	-	-	-	-	-	-	-

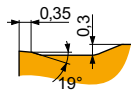

RM geometry for semi-rough to rough machining, and continuous to interrupted cuts.

DNMG 110408E-RM	T9315	0.8	190	0.40	2.0	-	-	-	180	0.40	2.0	-	-	-	-	-	-	-	-	-
	T9325	0.8	170	0.40	2.0	100	0.36	2.0	160	0.40	2.0	-	-	-	-	-	-	-	-	-
	T9335	0.8	145	0.40	2.0	85	0.36	2.0	-	-	-	-	-	-	-	-	-	-	-	-
DNMG 110412E-RM	T9315	1.2	230	0.30	2.0	-	-	-	215	0.30	2.0	-	-	-	-	-	-	-	-	-
	T9325	1.2	205	0.30	2.0	120	0.27	2.0	190	0.30	2.0	-	-	-	-	-	-	-	-	-
DNMG 150408E-RM	T9315	0.8	180	0.40	3.0	-	-	-	170	0.40	3.0	-	-	-	-	-	-	-	-	-
	T9325	0.8	165	0.40	3.0	95	0.36	3.0	155	0.40	3.0	-	-	-	-	-	-	-	-	-
	T9335	0.8	140	0.40	3.0	80	0.36	3.0	-	-	-	-	-	-	-	-	-	-	-	-
DNMG 150412E-RM	T7325	1.2	155	0.40	3.0	120	0.36	3.0	-	-	-	-	-	-	-	-	-	-	-	-
	T9315	1.2	190	0.40	3.0	-	-	-	180	0.40	3.0	-	-	-	-	-	-	-	-	-
	T9325	1.2	170	0.40	3.0	100	0.36	3.0	160	0.40	3.0	-	-	-	-	-	-	-	-	-
	T9335	1.2	150	0.40	3.0	90	0.36	3.0	-	-	-	-	-	-	-	-	-	-	-	-
DNMG 150608E-RM	T5305	0.8	230	0.40	3.0	-	-	-	215	0.40	3.0	-	-	-	-	-	-	-	-	-
	T5315	0.8	205	0.40	3.0	-	-	-	190	0.40	3.0	-	-	-	-	-	-	-	-	-
	T7325	0.8	145	0.40	3.0	110	0.36	3.0	-	-	-	-	-	-	-	-	-	-	-	-
	T7335	0.8	135	0.40	3.0	105	0.36	3.0	-	-	-	-	-	-	-	-	-	-	-	-
	T8315	0.8	135	0.40	3.0	80	0.36	3.0	125	0.40	3.0	-	-	-	-	-	-	-	-	-
	T8430	0.8	135	0.40	3.0	75	0.36	3.0	110	0.40	3.0	-	-	-	-	-	-	-	-	-
	T9310	0.8	200	0.40	3.0	-	-	-	190	0.40	3.0	-	-	-	-	-	-	-	-	-
	T9315	0.8	180	0.40	3.0	-	-	-	170	0.40	3.0	-	-	-	-	-	-	-	-	-
	T9325	0.8	165	0.40	3.0	95	0.36	3.0	155	0.40	3.0	-	-	-	-	-	-	-	-	-
	T9335	0.8	140	0.40	3.0	80	0.36	3.0	-	-	-	-	-	-	-	-	-	-	-	-
DNMG 150612E-RM	T5305	1.2	240	0.40	3.0	-	-	-	225	0.40	3.0	-	-	-	-	-	-	-	-	-
	T5315	1.2	215	0.40	3.0	-	-	-	200	0.40	3.0	-	-	-	-	-	-	-	-	-
	T7325	1.2	155	0.40	3.0	120	0.36	3.0	-	-	-	-	-	-	-	-	-	-	-	-
	T8430	1.2	140	0.40	3.0	75	0.36	3.0	115	0.40	3.0	-	-	-	-	-	-	-	-	-
	T9310	1.2	210	0.40	3.0	-	-	-	195	0.40	3.0	-	-	-	-	-	-	-	-	-
	T9315	1.2	190	0.40	3.0	-	-	-	180	0.40	3.0	-	-	-	-	-	-	-	-	-
	T9325	1.2	170	0.40	3.0	100	0.36	3.0	160	0.40	3.0	-	-	-	-	-	-	-	-	-
T9335	1.2	150	0.40	3.0	90	0.36	3.0	-	-	-	-	-	-	-	-	-	-	-	-	
DNMG 150616E-RM	T5315	1.6	225	0.40	3.0	-	-	-	210	0.40	3.0	-	-	-	-	-	-	-	-	-
	T9315	1.6	200	0.40	3.0	-	-	-	190	0.40	3.0	-	-	-	-	-	-	-	-	-
	T9325	1.6	180	0.40	3.0	105	0.36	3.0	170	0.40	3.0	-	-	-	-	-	-	-	-	-
	T9335	1.6	155	0.40	3.0	90	0.36	3.0	-	-	-	-	-	-	-	-	-	-	-	-



Suitability and starting values for cutting speed (vc), feed (f) and depth of cut (ap). Refer to our Machining Calculator app for further calculations.

Product	RE (mm)	P			M			K			N			S			H		
		vc (m/min)	f (mm/rev)	ap (mm)	vc (m/min)	f (mm/rev)	ap (mm)	vc (m/min)	f (mm/rev)	ap (mm)	vc (m/min)	f (mm/rev)	ap (mm)	vc (m/min)	f (mm/rev)	ap (mm)	vc (m/min)	f (mm/rev)	ap (mm)

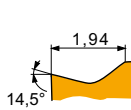

SF geometry with positive design for fine-finish machining of thin walls and continuous cuts.

DNMG 110404E-SF	T6310	0.4	150	0.15	0.8	105	0.14	0.8	120	0.15	0.8	450	0.18	0.8	45	0.12	0.6	30	0.11	0.3
	T8315	0.4	160	0.15	0.8	95	0.14	0.8	150	0.15	0.8	480	0.18	0.8	40	0.12	0.6	30	0.11	0.3
	T8430	0.4	180	0.15	0.8	95	0.14	0.8	145	0.15	0.8	495	0.18	0.8	35	0.12	0.6	30	0.11	0.3
DNMG 110408E-SF	T6310	0.8	175	0.17	0.8	125	0.15	0.8	140	0.17	0.8	525	0.20	0.8	50	0.14	0.6	35	0.11	0.7
	T8315	0.8	180	0.17	0.8	105	0.15	0.8	170	0.17	0.8	540	0.20	0.8	45	0.14	0.6	35	0.11	0.7
	T8430	0.8	200	0.17	0.8	110	0.15	0.8	165	0.17	0.8	555	0.20	0.8	40	0.14	0.6	35	0.11	0.7
DNMG 150404E-SF	T6310	0.4	140	0.15	1.5	100	0.14	1.5	110	0.15	1.5	420	0.18	1.5	40	0.12	1.2	25	0.11	0.3
	T8315	0.4	150	0.15	1.5	90	0.14	1.5	140	0.15	1.5	450	0.18	1.5	35	0.12	1.2	30	0.11	0.3
	T8430	0.4	165	0.15	1.5	90	0.14	1.5	135	0.15	1.5	450	0.18	1.5	35	0.12	1.2	25	0.11	0.3
DNMG 150408E-SF	T6310	0.8	160	0.17	1.5	115	0.15	1.5	125	0.17	1.5	480	0.20	1.5	45	0.14	1.2	30	0.11	0.7
	T8315	0.8	170	0.17	1.5	100	0.15	1.5	160	0.17	1.5	510	0.20	1.5	40	0.14	1.2	30	0.11	0.7
	T8430	0.8	190	0.17	1.5	105	0.15	1.5	155	0.17	1.5	525	0.20	1.5	40	0.14	1.2	30	0.11	0.7
DNMG 150604E-SF	H07	0.4	-	-	-	70	0.14	1.5	115	0.15	1.5	360	0.18	1.5	35	0.12	1.2	-	-	-
	T6310	0.4	140	0.15	1.5	100	0.14	1.5	110	0.15	1.5	420	0.18	1.5	40	0.12	1.2	25	0.11	0.3
	T7325	0.4	155	0.17	1.5	120	0.15	1.5	-	-	-	-	-	50	0.15	1.2	-	-	-	
	T8315	0.4	150	0.15	1.5	90	0.14	1.5	140	0.15	1.5	450	0.18	1.5	35	0.12	1.2	30	0.11	0.3
DNMG 150608E-SF	H07	0.8	-	-	-	80	0.15	1.5	130	0.17	1.5	415	0.20	1.5	40	0.14	1.2	-	-	-
	T6310	0.8	160	0.17	1.5	115	0.15	1.5	125	0.17	1.5	480	0.20	1.5	45	0.14	1.2	30	0.11	0.7
	T7325	0.8	185	0.17	1.5	140	0.15	1.5	-	-	-	-	-	60	0.15	1.2	-	-	-	
	T8315	0.8	170	0.17	1.5	100	0.15	1.5	160	0.17	1.5	510	0.20	1.5	40	0.14	1.2	30	0.11	0.7
	T8430	0.8	190	0.17	1.5	105	0.15	1.5	155	0.17	1.5	525	0.20	1.5	40	0.14	1.2	30	0.11	0.7
	T9315	0.8	255	0.17	1.5	-	-	-	240	0.17	1.5	-	-	-	-	-	-	50	0.12	0.7
	T9325	0.8	235	0.17	1.5	140	0.15	1.5	220	0.17	1.5	-	-	-	50	0.15	1.2	-	-	-
DNMG 150612E-SF	T6310	1.2	155	0.25	1.5	110	0.23	1.5	125	0.25	1.5	465	0.30	1.5	45	0.18	1.2	30	0.13	0.9

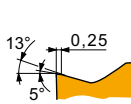

SM geometry with positive design for medium machining, and continuous to interrupted cuts.

DNMG 110404E-SM	T6310	0.4	140	0.20	0.8	100	0.18	0.8	110	0.20	0.8	420	0.24	0.8	40	0.18	0.6	25	0.14	0.3
	T7325	0.4	160	0.20	0.8	120	0.18	0.8	-	-	-	-	-	50	0.18	0.6	-	-	-	
	T8430	0.4	155	0.20	0.8	85	0.18	0.8	130	0.20	0.8	435	0.24	0.8	30	0.18	0.6	25	0.14	0.3
	T9325	0.4	190	0.20	0.8	110	0.18	0.8	180	0.20	0.8	-	-	-	40	0.18	0.6	-	-	-
DNMG 110408E-SM	T6310	0.8	150	0.25	1.2	105	0.23	1.2	120	0.25	1.2	450	0.30	1.2	45	0.20	1.0	30	0.13	0.7
	T7325	0.8	170	0.25	1.2	130	0.23	1.2	-	-	-	-	-	55	0.20	1.0	-	-	-	
	T7335	0.8	160	0.25	1.2	120	0.23	1.2	-	-	-	-	-	50	0.20	1.0	-	-	-	
	T8430	0.8	170	0.25	1.2	90	0.23	1.2	135	0.25	1.2	465	0.30	1.2	35	0.20	1.0	25	0.13	0.7
	T9325	0.8	200	0.25	1.2	120	0.23	1.2	190	0.25	1.2	-	-	-	45	0.20	1.0	-	-	-
DNMG 150404E-SM	T6310	0.4	130	0.20	1.7	90	0.18	1.7	100	0.20	1.7	390	0.24	1.7	35	0.18	1.4	25	0.14	0.3
DNMG 150408E-SM	T6310	0.8	140	0.25	1.7	100	0.23	1.7	110	0.25	1.7	420	0.30	1.7	40	0.20	1.4	25	0.13	0.7
DNMG 150604E-SM	T6310	0.4	130	0.20	1.7	90	0.18	1.7	100	0.20	1.7	390	0.24	1.7	35	0.18	1.4	25	0.14	0.3
	T7325	0.4	145	0.20	1.7	110	0.18	1.7	-	-	-	-	-	45	0.18	1.4	-	-	-	
	T7335	0.4	140	0.20	1.7	105	0.18	1.7	-	-	-	-	-	45	0.18	1.4	-	-	-	
	T8430	0.4	145	0.20	1.7	80	0.18	1.7	120	0.20	1.7	405	0.24	1.7	30	0.18	1.4	25	0.14	0.3
	T9315	0.4	200	0.20	1.7	-	-	-	190	0.20	1.7	-	-	-	-	-	-	40	0.14	0.3
	T9325	0.4	180	0.20	1.7	105	0.18	1.7	170	0.20	1.7	-	-	-	40	0.18	1.4	-	-	-
DNMG 150608E-SM	T6310	0.8	140	0.25	1.7	100	0.23	1.7	110	0.25	1.7	420	0.30	1.7	40	0.20	1.4	25	0.13	0.7
	T7325	0.8	160	0.25	1.7	120	0.23	1.7	-	-	-	-	-	50	0.20	1.4	-	-	-	
	T7335	0.8	155	0.25	1.7	120	0.23	1.7	-	-	-	-	-	50	0.20	1.4	-	-	-	
	T8430	0.8	155	0.25	1.7	85	0.23	1.7	130	0.25	1.7	435	0.30	1.7	30	0.20	1.4	25	0.13	0.7
	T9315	0.8	215	0.25	1.7	-	-	-	200	0.25	1.7	-	-	-	-	-	-	40	0.13	0.7
DNMG 150612E-SM	T6310	1.2	145	0.30	1.7	100	0.27	1.7	115	0.30	1.7	435	0.36	1.7	40	0.24	1.4	25	0.15	0.9
	T7325	1.2	160	0.30	1.7	120	0.27	1.7	-	-	-	-	-	50	0.24	1.4	-	-	-	
	T8430	1.2	155	0.30	1.7	85	0.27	1.7	130	0.30	1.7	435	0.36	1.7	30	0.24	1.4	25	0.15	0.9
	T9315	1.2	210	0.30	1.7	-	-	-	195	0.30	1.7	-	-	-	-	-	-	40	0.15	0.9



Suitability and starting values for cutting speed (vc), feed (f) and depth of cut (ap). Refer to our Machining Calculator app for further calculations.

Product	RE (mm)	P			M			K			N			S			H		
		vc (m/min)	f (mm/rev)	ap (mm)	vc (m/min)	f (mm/rev)	ap (mm)	vc (m/min)	f (mm/rev)	ap (mm)	vc (m/min)	f (mm/rev)	ap (mm)	vc (m/min)	f (mm/rev)	ap (mm)	vc (m/min)	f (mm/rev)	ap (mm)

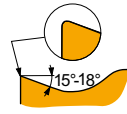

ER-SI geometry with positive right-handed design for fine-finish to semi-rough machining, and continuous cuts.

DNMG 110404ER-SI	T7325	0.4	185	0.20	1.0	140	0.18	1.0	-	-	-	-	-	-	60	0.18	0.8	-	-	-
	T7335	0.4	180	0.20	1.0	140	0.18	1.0	-	-	-	-	-	-	55	0.18	0.8	-	-	-
	T8430	0.4	185	0.20	1.0	100	0.18	1.0	-	-	-	510	0.24	1.0	40	0.18	0.8	-	-	-
	T9325	0.4	225	0.20	1.0	135	0.18	1.0	-	-	-	-	-	-	50	0.18	0.8	-	-	-
DNMG 110408ER-SI	T7335	0.8	175	0.35	1.0	135	0.32	1.0	-	-	-	-	-	-	55	0.25	0.8	-	-	-
	T8430	0.8	180	0.35	1.0	95	0.32	1.0	-	-	-	495	0.42	1.0	35	0.25	0.8	-	-	-
	T9325	0.8	210	0.35	1.0	125	0.32	1.0	-	-	-	-	-	45	0.25	0.8	-	-	-	
DNMG 150404ER-SI	T8430	0.4	175	0.20	1.5	95	0.18	1.5	-	-	-	480	0.24	1.5	35	0.18	1.2	-	-	-
	T9325	0.4	220	0.20	1.5	130	0.18	1.5	-	-	-	-	-	45	0.18	1.2	-	-	-	
DNMG 150408ER-SI	T8430	0.8	170	0.35	1.5	90	0.32	1.5	-	-	-	465	0.42	1.5	35	0.25	1.2	-	-	-
	T9325	0.8	200	0.35	1.5	120	0.32	1.5	-	-	-	-	-	45	0.25	1.2	-	-	-	
DNMG 150604ER-SI	T7325	0.4	180	0.20	1.5	140	0.18	1.5	-	-	-	-	-	55	0.18	1.2	-	-	-	
	T7335	0.4	170	0.20	1.5	130	0.18	1.5	-	-	-	-	-	55	0.18	1.2	-	-	-	
	T8315	0.4	165	0.20	1.5	95	0.18	1.5	-	-	-	495	0.24	1.5	40	0.18	1.2	-	-	-
	T8430	0.4	175	0.20	1.5	95	0.18	1.5	-	-	-	480	0.24	1.5	35	0.18	1.2	-	-	-
	T9325	0.4	220	0.20	1.5	130	0.18	1.5	-	-	-	-	-	45	0.18	1.2	-	-	-	
	T9335	0.4	185	0.20	1.5	110	0.18	1.5	-	-	-	-	-	40	0.18	1.2	-	-	-	
	T9335	0.4	180	0.35	1.5	140	0.32	1.5	-	-	-	-	-	55	0.25	1.2	-	-	-	
DNMG 150608ER-SI	T7325	0.8	180	0.35	1.5	140	0.32	1.5	-	-	-	-	-	55	0.25	1.2	-	-	-	
	T7335	0.8	170	0.35	1.5	130	0.32	1.5	-	-	-	-	-	55	0.25	1.2	-	-	-	
	T8315	0.8	165	0.35	1.5	95	0.32	1.5	-	-	-	495	0.42	1.5	40	0.25	1.2	-	-	-
	T8430	0.8	170	0.35	1.5	90	0.32	1.5	-	-	-	465	0.42	1.5	35	0.25	1.2	-	-	-
	T9325	0.8	200	0.35	1.5	120	0.32	1.5	-	-	-	-	-	45	0.25	1.2	-	-	-	
	T9335	0.8	180	0.35	1.5	105	0.32	1.5	-	-	-	-	-	40	0.25	1.2	-	-	-	
	T9335	0.8	180	0.35	1.5	140	0.32	1.5	-	-	-	-	-	55	0.25	1.2	-	-	-	

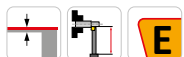
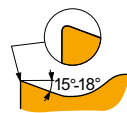

EL-SI geometry with positive left-handed design, for fine-finish to semi-rough machining, and continuous cuts.

DNMG 110404EL-SI	T8430	0.4	185	0.20	1.0	100	0.18	1.0	-	-	-	510	0.24	1.0	40	0.18	0.8	-	-	-
	T9325	0.4	225	0.20	1.0	135	0.18	1.0	-	-	-	-	-	50	0.18	0.8	-	-	-	
DNMG 110408EL-SI	T8430	0.8	180	0.35	1.0	95	0.32	1.0	-	-	-	495	0.42	1.0	35	0.25	0.8	-	-	-
	T9325	0.8	210	0.35	1.0	125	0.32	1.0	-	-	-	-	-	45	0.25	0.8	-	-	-	
DNMG 150404EL-SI	T8430	0.4	175	0.20	1.5	95	0.18	1.5	-	-	-	480	0.24	1.5	35	0.18	1.2	-	-	-
	T9325	0.4	220	0.20	1.5	130	0.18	1.5	-	-	-	-	-	45	0.18	1.2	-	-	-	
DNMG 150408EL-SI	T7335	0.8	170	0.35	1.5	130	0.32	1.5	-	-	-	-	-	55	0.25	1.2	-	-	-	
	T8430	0.8	170	0.35	1.5	90	0.32	1.5	-	-	-	465	0.42	1.5	35	0.25	1.2	-	-	-
DNMG 150604EL-SI	T7325	0.4	180	0.20	1.5	140	0.18	1.5	-	-	-	-	-	55	0.18	1.2	-	-	-	
	T7335	0.4	170	0.20	1.5	130	0.18	1.5	-	-	-	-	-	55	0.18	1.2	-	-	-	
DNMG 150608EL-SI	T8315	0.4	165	0.20	1.5	95	0.18	1.5	-	-	-	495	0.24	1.5	40	0.18	1.2	-	-	-
	T8430	0.4	175	0.20	1.5	95	0.18	1.5	-	-	-	480	0.24	1.5	35	0.18	1.2	-	-	-
	T9325	0.4	220	0.20	1.5	130	0.18	1.5	-	-	-	-	-	45	0.18	1.2	-	-	-	
	T9335	0.4	185	0.20	1.5	110	0.18	1.5	-	-	-	-	-	40	0.18	1.2	-	-	-	
	T7325	0.8	180	0.35	1.5	140	0.32	1.5	-	-	-	-	-	55	0.25	1.2	-	-	-	
	T7335	0.8	170	0.35	1.5	130	0.32	1.5	-	-	-	-	-	55	0.25	1.2	-	-	-	
	T8315	0.8	165	0.35	1.5	95	0.32	1.5	-	-	-	495	0.42	1.5	40	0.25	1.2	-	-	-
DNMG 150608W-MR	T8430	0.8	170	0.35	1.5	90	0.32	1.5	-	-	-	465	0.42	1.5	35	0.25	1.2	-	-	-
	T9325	0.8	200	0.35	1.5	120	0.32	1.5	-	-	-	-	-	45	0.25	1.2	-	-	-	
	T9335	0.8	180	0.35	1.5	105	0.32	1.5	-	-	-	-	-	40	0.25	1.2	-	-	-	
	T9335	0.8	180	0.35	1.5	140	0.32	1.5	-	-	-	-	-	55	0.25	1.2	-	-	-	

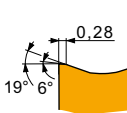

W-MR wiper geometry for finish to rough machining with increased feed rates and improved surface finish.

DNMG 150608W-MR	T9315	0.8	170	0.40	1.5	-	-	-	160	0.40	1.5	-	-	-	-	-	-	-	-	-
	T9325	0.8	155	0.40	1.5	90	0.36	1.5	145	0.40	1.5	-	-	-	-	-	-	-	-	-



Suitability and starting values for cutting speed (vc), feed (f) and depth of cut (ap). Refer to our Machining Calculator app for further calculations.

Product	RE (mm)	P			M			K			N			S			H		
		vc (m/min)	f (mm/rev)	ap (mm)	vc (m/min)	f (mm/rev)	ap (mm)	vc (m/min)	f (mm/rev)	ap (mm)	vc (m/min)	f (mm/rev)	ap (mm)	vc (m/min)	f (mm/rev)	ap (mm)	vc (m/min)	f (mm/rev)	ap (mm)

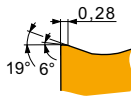

W-MR wiper geometry for finish to rough machining with increased feed rates and improved surface finish.

DNMM 150612W-MR	T9310	1.2	175	0.50	1.5	—	—	—	165	0.50	1.5	—	—	—	—	—	—	—	—
	T9315	1.2	160	0.50	1.5	—	—	—	150	0.50	1.5	—	—	—	—	—	—	—	—
	T9325	1.2	145	0.50	1.5	85	0.45	1.5	135	0.50	1.5	—	—	—	—	—	—	—	—

DNMM



	IC (mm)	D1 (mm)	L (mm)	S (mm)
1506	12.700	5.16	15.50	6.35

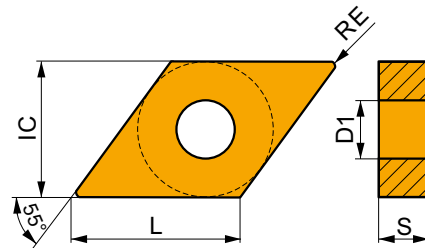

Suitability and starting values for cutting speed (vc), feed (f) and depth of cut (ap). Refer to our Machining Calculator app for further calculations.

Product	RE (mm)	P			M			K			N			S			H		
		vc (m/min)	f (mm/rev)	ap (mm)	vc (m/min)	f (mm/rev)	ap (mm)	vc (m/min)	f (mm/rev)	ap (mm)	vc (m/min)	f (mm/rev)	ap (mm)	vc (m/min)	f (mm/rev)	ap (mm)	vc (m/min)	f (mm/rev)	ap (mm)

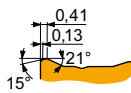

NR2 geometry for semi-rough to rough machining, and continuous to interrupted cuts.

DNMM 150608E-NR2	T9325	0.8	155	0.40	3.0	90	0.36	3.0	145	0.40	3.0	—	—	—	30	0.32	2.4	—	—	—
------------------	-------	-----	-----	------	-----	----	------	-----	-----	------	-----	---	---	---	----	------	-----	---	---	---

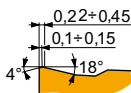

OR geometry for semi-rough to rough machining, and continuous to interrupted cuts.

DNMM 150608E-OR	T9325	0.8	155	0.40	3.0	90	0.36	3.0	145	0.40	3.0	—	—	—	30	0.28	2.4	—	—	—
DNMM 150612E-OR	T9315	1.2	180	0.40	3.0	—	—	—	170	0.40	3.0	—	—	—	—	—	—	—	—	—
	T9325	1.2	165	0.40	3.0	95	0.36	3.0	155	0.40	3.0	—	—	—	35	0.32	2.4	—	—	—
	T9335	1.2	145	0.40	3.0	85	0.36	3.0	—	—	—	—	—	—	30	0.32	2.4	—	—	—
DNMM 150616E-OR	T9325	1.6	165	0.45	3.0	95	0.41	3.0	155	0.45	3.0	—	—	—	35	0.41	2.4	—	—	—



DDJN(RL) EXT

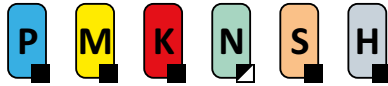

External Double Clamp Turning Holder with 93° Cutting Angle for DN.. Insert

External Right/Left hand double clamp tool holder with 93° cutting angle. Suited for longitudinal turning with shoulder, copying, chamfering and facing with negative DN.. 11 or 15 size inserts. Available with shank size 20x20 up to 32x32 mm. Body treated for longer tool life.

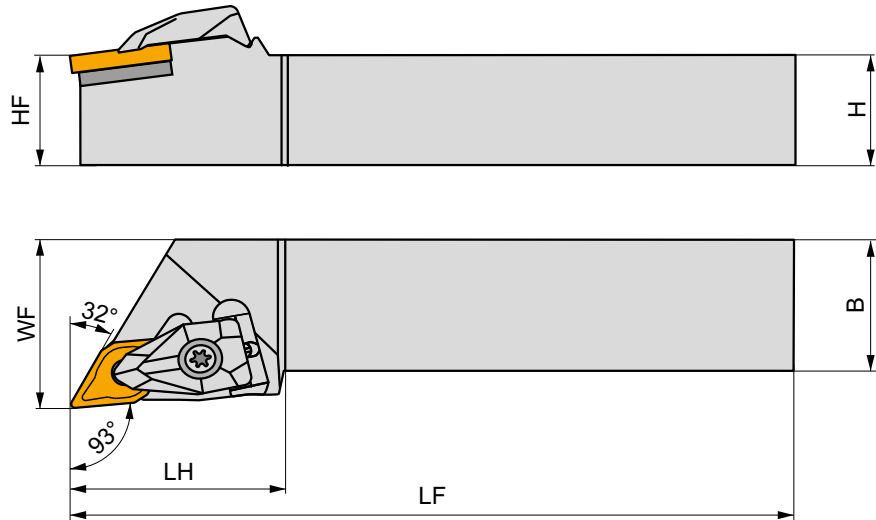
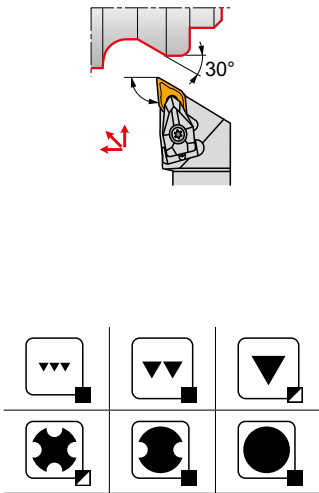

Product	H	B	HF	WF	LF	LH	LAMS	GAMO	kg			
	(mm)	(mm)	(mm)	(mm)	(mm)	(mm)	(°)	(°)				
R DDJNR 2020 K 11	20	20	20	25	125	30.2	-7	-6	0.45	G1046	DD11	-
DDJNR 2525 M 11	25	25	25	32	150	30.2	-7	-6	0.77	G1046	DD11	-
DDJNR 2020 K 15	20	20	20	25	125	39.4	-7	-6	0.42	G1044	DD154	AT002
DDJNR 2525 M 15	25	25	25	32	150	39.4	-7	-6	0.74	G1044	DD154	AT002
DDJNR 3225 P 15	32	25	32	32	170	39.4	-7	-6	1.12	G1044	DD154	AT002
DDJNR 3232 P 15	32	32	32	40	170	39.4	-7	-6	1.33	G1044	DD154	AT002
L DDJNL 2020 K 11	20	20	20	25	125	30.2	-7	-6	0.45	G1046	DD11	-
DDJNL 2525 M 11	25	25	25	32	150	30.2	-7	-6	0.77	G1046	DD11	-
DDJNL 2020 K 15	20	20	20	25	125	39.4	-7	-6	0.42	G1044	DD154	AT002
DDJNL 2525 M 15	25	25	25	32	150	39.4	-7	-6	0.74	G1044	DD154	AT002
DDJNL 3225 P 15	32	25	32	32	170	39.4	-7	-6	1.01	G1044	DD154	AT002
DDJNL 3232 P 15	32	32	32	40	170	39.4	-7	-6	1.34	G1044	DD154	AT002

G1044	DN.. 1506..
G1046	DN.. 1104..

DD11	DCS 09	1.7	DDS 267-01	US 2004-T09P	FLAG T09P
DD154	DCS 12	3.9	DDS 266-02	US 2002-T15P	FLAG T15P/3,5

AT002a	DN.. 1504..	-	DDS 266-01
AT002b	CER DN.N 1506..	DCS 12C4	-
AT002c	CER DN.A 1506..	DCS 12C2	-



PDJN(RL) EXT

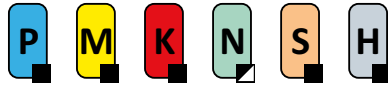

PRAMET

P



External Lever Lock Turning Holder with 93° Cutting Angle for DN.. Insert

External Right/Left hand lever lock tool holder with 93° cutting angle. Suited for longitudinal turning with shoulder, copy turning up to 30°, and chamfering with negative DN.. 11 and 15 size inserts. Available with shank size 20x20 up to 32x32 mm. Body treated for longer tool life.

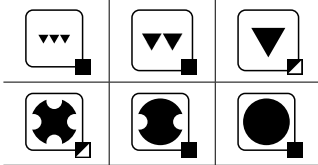
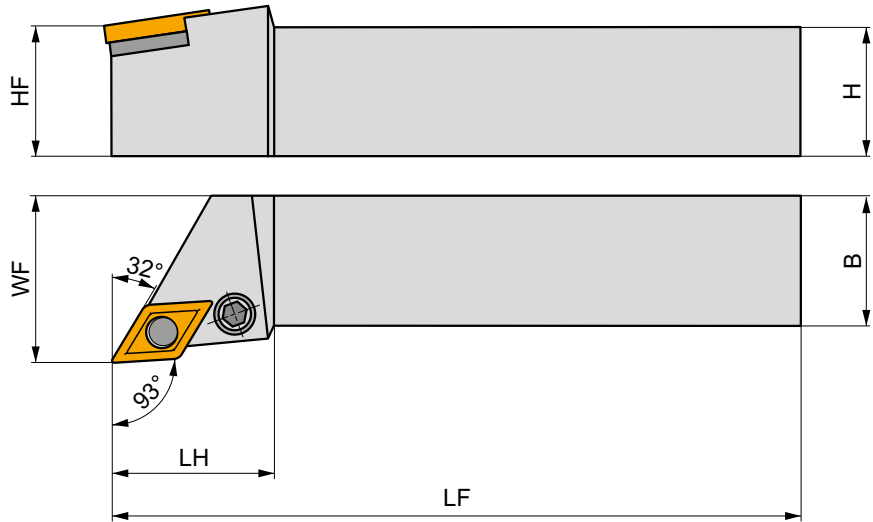
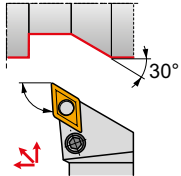

Product	H	B	HF	WF	LF	LH	LAMS	GAMO	kg	GI046	PD60	
	(mm)	(mm)	(mm)	(mm)	(mm)	(mm)	(°)	(°)				
R	PDJNR 2020 K 11	20	20	20	25	125	30	-6	-6	0.43	GI046	PD60
	PDJNR 2525 M 11	25	25	25	32	150	30	-6	-6	0.73	GI046	PD60
	PDJNR 3225 P 11	32	25	32	32	170	30	-6	-6	1.10	GI046	PD60
	PDJNR 2020 K 15	20	20	20	25	125	40	-6	-6	0.44	GI044	PD31
	PDJNR 2525 M 15	25	25	25	32	150	40	-6	-6	0.73	GI044	PD30
	PDJNR 3225 P 15	32	25	32	32	170	40	-6	-6	1.05	GI044	PD30
L	PDJNL 2020 K 11	20	20	20	25	125	30	-6	-6	0.41	GI046	PD60
	PDJNL 2525 M 11	25	25	25	32	150	30	-6	-6	0.73	GI046	PD60
	PDJNL 3225 P 11	32	25	32	32	170	30	-6	-6	1.10	GI046	PD60
	PDJNL 2020 K 15	20	20	20	25	125	40	-6	-6	0.42	GI044	PD31
	PDJNL 2525 M 15	25	25	25	32	150	40	-6	-6	0.73	GI044	PD30
	PDJNL 3225 P 15	32	25	32	32	170	40	-6	-6	0.98	GI044	PD30
PDJNL 3232 P 15	32	32	32	40	170	40	-6	-6	1.30	GI044	PD30	



GI044
GI046

DN.. 1506..
DN.. 1104..



PD30	DNU 150308	PU 03	US 36	6.0	M 8x1	26	NT 05	MT 05	HXK 4
PD31	DNU 150308	PU 03	US 40	6.0	M 8x1	20.5	NT 05	MT 05	HXK 4
PD60	PDN 110308	PU 3512	PS 0616	3.0	M 6	16	NT 5153	MT 0912	HXK 2.5



PDNN(RL) EXT

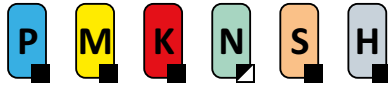

External Lever Lock Turning Holder with 63° Cutting Angle for DN.. Insert

External Right/Left hand lever lock 63° (neutral) tool holder. Suited for longitudinal turning without shoulder, taper, copy, and chamfer turning with negative DN.. 15 size inserts. Available with shank size 20x20 up to 32x25 mm. Body treated for longer tool life.

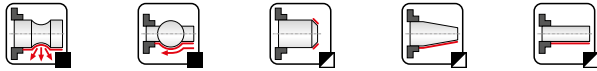
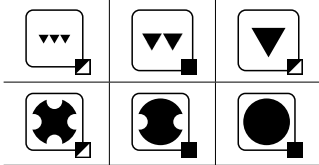
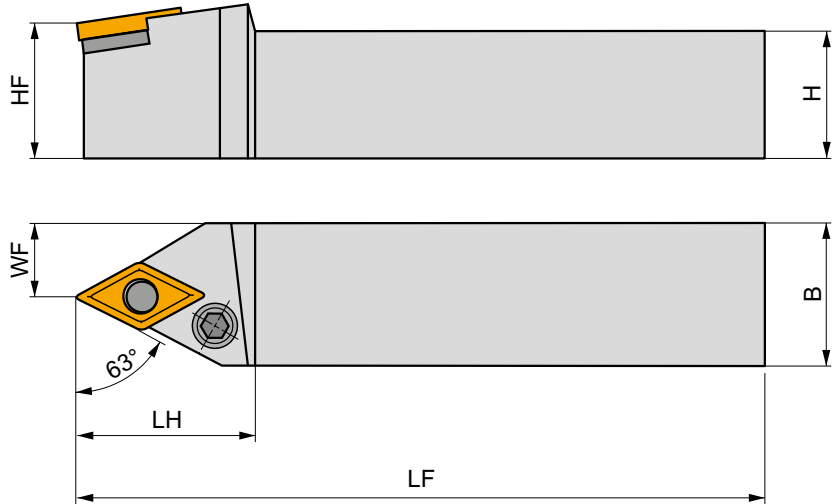
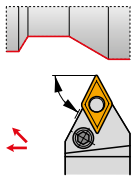

Product	H	B	HF	WF	LF	LH	LAMS	GAMO	kg		
	(mm)	(mm)	(mm)	(mm)	(mm)	(mm)	(°)	(°)			
R PDNNR 2020 K 11	20	20	20	10	125	24	-6	-6	0.39	GI046	PD60
PDNNR 2525 M 11	25	25	25	12.5	150	30	-6	-6	0.60	GI046	PD60
PDNNR 2525 M 15	25	25	25	12.5	150	40	-6	-6	0.64	GI044	PD30
PDNNR 3225 P 15	32	25	32	12.5	170	40	-6	-6	1.05	GI044	PD30
L PDNNL 2020 K 11	20	20	20	10	125	24	-6	-6	0.40	GI046	PD60
PDNNL 2525 M 11	25	25	25	12.5	150	30	-6	-6	0.60	GI046	PD60
PDNNL 2525 M 15	25	25	25	12.5	150	40	-6	-6	0.07	GI044	PD30
PDNNL 3225 P 15	32	25	32	12.5	170	40	-6	-6	1.05	GI044	PD30



GI044

DN.. 1506..

GI046

DN.. 1104..



PD30

DNU 150308

PU 03

US 36

6.0

M 8x1

26

NT 05

MT 05

HXK 4

PD60

PDN 110308

PU 3512

PS 0616

3.0

M 6

16

NT 5153

MT 0912

HXK 2.5



C.-DDJN(RL) EXT



Ext. PSC Quick Change Tool, Double Clamp, 93° Cutting Angle for DN.. Insert

External Right/Left hand double clamp tool, through coolant, with 93° cutting angle for taper and longitudinal turning with shoulder, copying and chamfering with negative DN.. 11 or 15 size inserts. Available with PSC (Polygon Shank Coupling) C4 up to C6 coupling. Body treated for longer tool life.

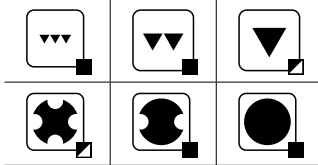
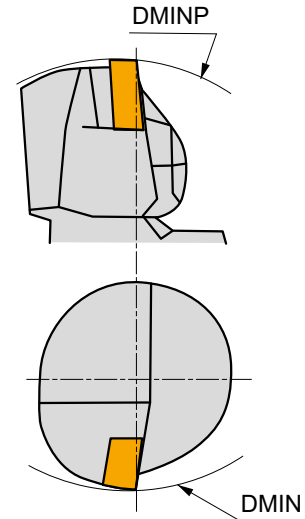
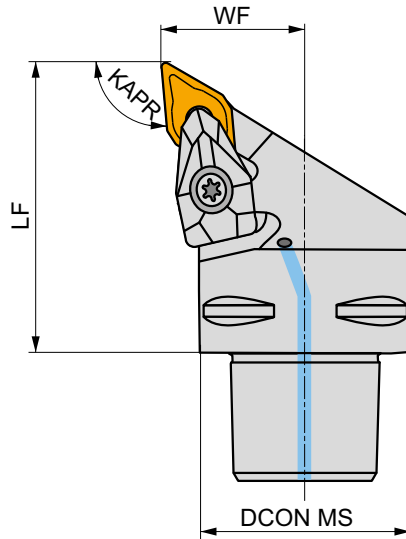
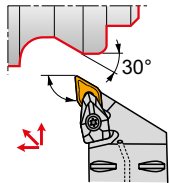

Product	DCON MS (mm)	DMIN (mm)	DMINP (mm)	WF (mm)	LF (mm)	KAPR (°)	LAM S (°)	GAMO (°)					
R C4-DDJNR-27050-11	40	60	140	27	50	93	-7	-6	✓	0.38	GI046	C-DD11	-
C4-DDJNR-27055-15	40	110	145	27	55	93	-7	-6	✓	0.43	GI044	C-DD154-1	AT002
C5-DDJNR-35060-15	50	110	165	35	60	93	-7	-6	✓	0.72	GI044	C-DD154-2	AT002
C6-DDJNR-45065-15	63	110	190	45	65	93	-7	-6	✓	1.18	GI044	C-DD154-3	AT002
L C4-DDJNL-27050-11	40	60	140	27	50	93	-7	-6	✓	0.39	GI046	C-DD11	-
C4-DDJNL-27055-15	40	110	145	27	55	93	-7	-6	✓	0.43	GI044	C-DD154-1	AT002
C5-DDJNL-35060-15	50	110	165	35	60	93	-7	-6	✓	0.72	GI044	C-DD154-2	AT002
C6-DDJNL-45065-15	63	110	190	45	65	93	-7	-6	✓	1.18	GI044	C-DD154-3	AT002



GI044
GI046

DN.. 1506..
DN.. 1104..



C-DD11	DCS 09	1.7	DDS 267-01	US 2004-T09P	FLAG T09P	CN 034-01
C-DD154-1	DCS 12	3.9	DDS 266-02	US 2002-T15P	FLAG T15P/3,5	CN 034-01
C-DD154-2	DCS 12	3.9	DDS 266-02	US 2002-T15P	FLAG T15P/3,5	CN 045-01
C-DD154-3	DCS 12	3.9	DDS 266-02	US 2002-T15P	FLAG T15P/3,5	CN 034-02



AT002a	DN.. 1504..	-	DDS 266-01
AT002b	CER DN.N 1506..	DCS 12C4	-
AT002c	CER DN.A 1506..	DCS 12C2	-
AT002d	CER DN.N 1504..	DCS 12C4	DDS 266-01
AT002e	CER DN.A 1504..	DCS 12C2	DDS 266-01



C.-DDNNN EXT



Ext. PSC Quick Change Tool, Double Clamp, 62.5° Cutting Angle for DN.. Insert

External Right/Left hand double clamp tool, through coolant, with 62.5° cutting angle for taper and longitudinal turning without shoulder, copying and chamfering with negative DN.. 15 size inserts. Available with PSC (Polygon Shank Coupling) C5 and C6 coupling. Body treated for longer tool life.

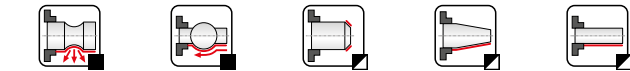
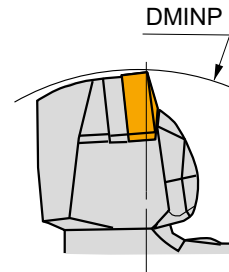
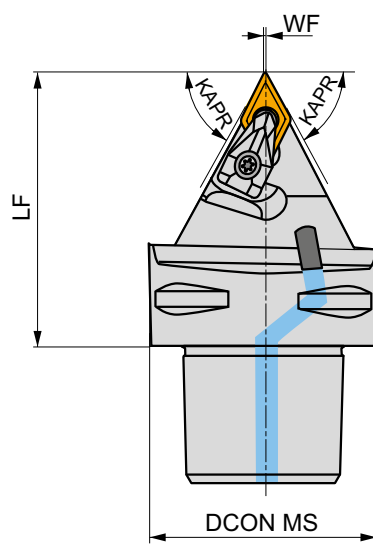
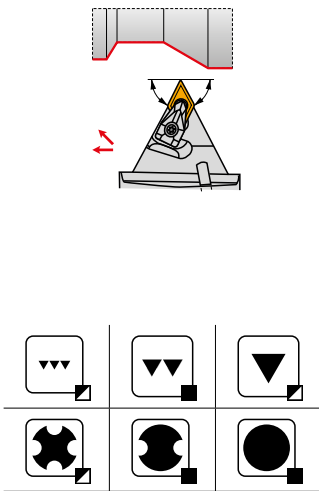

Product	DCON MS (mm)	DMINP (mm)	WF (mm)	LF (mm)	KAPR (°)	LAMS (°)	GAMO (°)		kg			
N C5-DDNNN-00060-15	50	165	0.5	60	62.5	-9	-5	✓	0.62	GI044	C-DD154-2	AT002
C6-DDNNN-00065-15	63	190	0.5	65	62.5	-9	-5	✓	1.06	GI044	C-DD154-2	AT002

	GI044		DN.. 1506..
--	-------	--	-------------

	C-DD154-2		DCS 12		3.9		DDS 266-02		US 2002-T15P		FLAG T15P/3,5		CN 045-01
--	-----------	--	--------	--	-----	--	------------	--	--------------	--	---------------	--	-----------

	AT002a		DN.. 1504..		-		DDS 266-01
AT002b	CER DN.N 1506..		DCS 12C2	-	-	-	-
AT002c	CER DN.A 1506..		DCS 12C4	-	-	-	-
AT002d	CER DN.N 1504..		DCS 12C4		DDS 266-01	-	-
AT002e	CER DN.A 1504..		DCS 12C2		DDS 266-01	-	-



LN

19/ 30/ 31

CARBIDE INSERTS

LN. X 19, LN. X 30



184

LNMT 31



185

MATCH THE RIGHT SIZE (example)

Insert

Tool Holder

LNMX 301940SN-TF

KTP-LANR 30

DKT(RL)-A1 + KTP

		LN..
		19 30
		KTP-LAN(RL)
	50x55	
	186	184 – 185, 193

DKT(RL)-A2 + KTP

		LN..
		19 30
		KTP-LAN(RL) KTP-LFN(RL)
	50x55	
	186	184 – 185, 193 – 194

DKT(RL)-B1 + KTP

		LN..
		19 30
		KTP-LAN(RL)
	50x49.5	
	187	184 – 185, 193

DKT(RL)-B2 + KTP

		LN..
		19 30
		KTP-LAN(RL) KTP-LFN(RL)
	50x49.5	
	187	184 – 185, 193 – 194

DKT(RL)-C1 + KTP

		LN..
		19 30
		KTP-LAN(RL)
	55x55	
	188	184 – 185, 193

DKT(RL)-C2 + KTP

		LN..
		19 30
		KTP-LAN(RL) KTP-LFN(RL) KTP-LAN(RL) 30/X
	55x55 55x52	
	188	184 – 185, 193 – 194

DKT(RL)-D1 + KTP

		LN..
		19 30
		KTP-LAN(RL)
	50x49.5	
	189	184 – 185, 19

DKT(RL)-D2 + KTP

		LN..
		19 30
		KTP-LAN(RL) KTP-LFN(RL)
	50x49.5	
	189	184 – 185, 193 – 194

S-DKT(RL)4065X + KTP

		LN..
		19 30
		KTP-LAN(RL) KTP-LFN(RL)
	45x65	
	190	184 – 185, 193 – 194

S-DKT(RL)5556 + KTP

		LN..
		19 30
		KTP-LAN(RL) KTP-LFN(RL)
	56x55	
	192	184 – 185, 193 – 194



LN.X 19, LN.X 30

	W1 (mm)	D1 (mm)	L (mm)	S (mm)
1919	10.000	6.35	19.05	19.05
3019	12.000	6.35	30.00	19.05

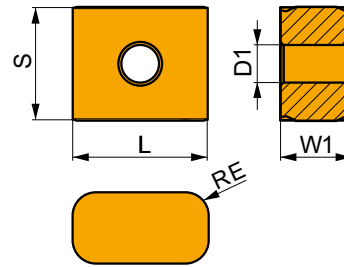

Suitability and starting values for cutting speed (vc), feed (f) and depth of cut (ap). Refer to our Machining Calculator app for further calculations.

Product	RE (mm)	P			M			K			N			S			H		
		vc (m/min)	f (mm/rev)	ap (mm)	vc (m/min)	f (mm/rev)	ap (mm)	vc (m/min)	f (mm/rev)	ap (mm)	vc (m/min)	f (mm/rev)	ap (mm)	vc (m/min)	f (mm/rev)	ap (mm)	vc (m/min)	f (mm/rev)	ap (mm)

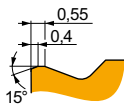

DF geometry for rough to heavy-rough machining, and continuous to interrupted cuts.

LNUX 191940SN-DF	T9325	4.0	65	1.10	4.0	–	–	–	60	1.10	4.0	–	–	–	–	–	–	–	–
-------------------------	--------------	-----	----	------	-----	---	---	---	----	------	-----	---	---	---	---	---	---	---	---

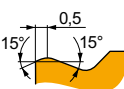

DM geometry for rough to heavy-rough machining, and continuous to interrupted cuts.

LNUX 301940SN-DM	9215	4.0	80	1.30	5.0	–	–	–	75	1.30	5.0	–	–	–	–	–	–	–	–
	T5315	4.0	80	1.30	5.0	–	–	–	75	1.30	5.0	–	–	–	–	–	15	0.55	2.7
	T9315	4.0	95	1.30	5.0	–	–	–	90	1.30	5.0	–	–	–	–	–	–	–	–
	T9325	4.0	80	1.30	5.0	–	–	–	75	1.30	5.0	–	–	–	–	–	–	–	–

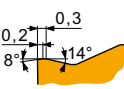

RF geometry for semi-rough to rough machining, and continuous to interrupted cuts.

LNMX 191940SN-RF	T9315	4.0	105	0.75	3.5	–	–	–	95	0.75	3.5	–	–	–	–	–	–	–	–
LNMX 301940SN-RF	T9315	4.0	105	0.75	5.0	–	–	–	95	0.75	5.0	–	–	–	–	–	–	–	–

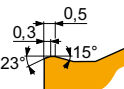

RM geometry for semi-rough to rough machining, and continuous to interrupted cuts.

LNMX 191940SN-RM	T9310	4.0	70	0.93	3.5	–	–	–	65	0.93	3.5	–	–	–	–	–	–	–	–
	T9315	4.0	105	0.93	3.5	–	–	–	95	0.93	3.5	–	–	–	–	–	–	–	–
	T9325	4.0	60	0.93	3.5	–	–	–	55	0.93	3.5	–	–	–	–	–	–	–	–
	T9335	4.0	55	1.18	6.0	–	–	–	50	1.18	6.0	–	–	–	–	–	–	–	–
LNMX 301940SN-RM	T9310	4.0	60	1.18	6.0	–	–	–	55	1.18	6.0	–	–	–	–	–	–	–	–
	T9315	4.0	95	1.18	6.0	–	–	–	90	1.18	6.0	–	–	–	–	–	–	–	–
	T9325	4.0	55	1.18	6.0	–	–	–	50	1.18	6.0	–	–	–	–	–	–	–	–

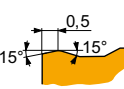

RR geometry for semi-rough to rough machining, and continuous to interrupted cuts.

LNMX 191940SN-RR	T5315	4.0	80	1.10	4.0	–	–	–	75	1.10	4.0	–	–	–	–	–	15	0.55	2.7
LNMX 301940SN-RR	T9325	4.0	55	1.10	7.0	–	–	–	50	1.10	7.0	–	–	–	–	–	–	–	–

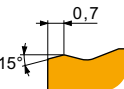



RR2 geometry for rough to heavy-rough machining, and continuous to interrupted cuts.

LNMX 191940SN-RR2	T5315	4.0	80	1.20	4.0	–	–	–	75	1.20	4.0	–	–	–	–	–	15	0.60	2.7
--------------------------	--------------	-----	----	------	-----	---	---	---	----	------	-----	---	---	---	---	---	----	------	-----

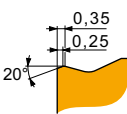

Suitability and starting values for cutting speed (vc), feed (f) and depth of cut (ap). Refer to our Machining Calculator app for further calculations.

Product	RE (mm)	P			M			K			N			S			H			
		vc (m/min)	f (mm/rev)	ap (mm)	vc (m/min)	f (mm/rev)	ap (mm)	vc (m/min)	f (mm/rev)	ap (mm)	vc (m/min)	f (mm/rev)	ap (mm)	vc (m/min)	f (mm/rev)	ap (mm)	vc (m/min)	f (mm/rev)	ap (mm)	
	0.35 0.25 20°																			
		TF geometry for semi-rough to rough machining, and continuous to interrupted cuts.																		
		LNMX 191940SN-TF	T5315	4.0	80	0.95	5.0	-	-	-	75	0.95	5.0	-	-	-	-	-	-	15
	T9315	4.0	75	0.95	5.0	-	-	-	70	0.95	5.0	-	-	-	-	-	-	15	0.48	2.7
	T9325	4.0	70	0.95	5.0	-	-	-	65	0.95	5.0	-	-	-	-	-	-	-	-	-
LNMX 301940SN-TF	4.0	T5315	80	0.95	7.0	-	-	-	75	0.95	7.0	-	-	-	-	-	-	15	0.48	2.7
		T9310	80	0.95	7.0	-	-	-	75	0.95	7.0	-	-	-	-	-	-	15	0.48	2.7
		T9315	75	0.95	7.0	-	-	-	70	0.95	7.0	-	-	-	-	-	-	15	0.48	2.7

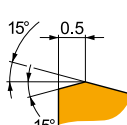
Product	RE (mm)	P			M			K			N			S			H			
		vc (m/min)	f (mm/rev)	ap (mm)	vc (m/min)	f (mm/rev)	ap (mm)	vc (m/min)	f (mm/rev)	ap (mm)	vc (m/min)	f (mm/rev)	ap (mm)	vc (m/min)	f (mm/rev)	ap (mm)	vc (m/min)	f (mm/rev)	ap (mm)	
	15° 0.5 15°																			
		Geometry for rough to heavy-rough machining, and continuous to interrupted cuts.																		
LNMX 191940*	S30	4.0	40	0.85	4.0	-	-	-	-	-	-	-	-	-	-	-	-	-	-	-
LNMX 301940*	S30	4.0	40	0.85	4.0	-	-	-	-	-	-	-	-	-	-	-	-	-	-	-

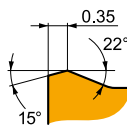
Product	RE (mm)	P			M			K			N			S			H			
		vc (m/min)	f (mm/rev)	ap (mm)	vc (m/min)	f (mm/rev)	ap (mm)	vc (m/min)	f (mm/rev)	ap (mm)	vc (m/min)	f (mm/rev)	ap (mm)	vc (m/min)	f (mm/rev)	ap (mm)	vc (m/min)	f (mm/rev)	ap (mm)	
	0.35 22° 15°																			
		S6 geometry for semi-rough to rough machining, continuous to interrupted cuts.																		
S-LNMX 301940-56*	T9310	4.0	80	1.00	5.0	-	-	-	75	1.00	5.0	-	-	-	-	-	-	15	0.48	2.7

* Special items



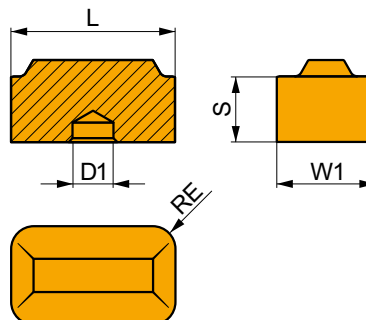

LNMT

	W1 (mm)	D1 (mm)	L (mm)	S (mm)
3112	19.050	7.93	31.75	12.70

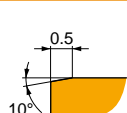

PRAMET

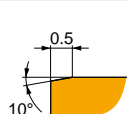
Suitability and starting values for cutting speed (vc), feed (f) and depth of cut (ap). Refer to our Machining Calculator app for further calculations.

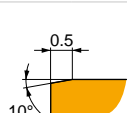
Product	RE (mm)	P			M			K			N			S			H			
		vc (m/min)	f (mm/rev)	ap (mm)	vc (m/min)	f (mm/rev)	ap (mm)	vc (m/min)	f (mm/rev)	ap (mm)	vc (m/min)	f (mm/rev)	ap (mm)	vc (m/min)	f (mm/rev)	ap (mm)	vc (m/min)	f (mm/rev)	ap (mm)	
	0.5 10°																			
		M geometry for finish to rough machining, continuous to interrupted cuts.																		
LNMT 311240SN-M	T9315	4.76	75	1.00	9.5	-	-	-	70	1.00	9.5	-	-	-	-	-	-	15	0.50	2.7
S-LNMT311240SN-M	T9310	4.76	-	-	-	-	-	-	-	-	-	-	-	-	-	-	-	-	-	-
	0.5 10°																			
		Geometry for finish to rough machining, continuous to interrupted cuts.																		
LNMT 311240	T9315	4.76	75	1.00	9.5	-	-	-	70	1.00	9.5	-	-	-	-	-	-	15	0.50	2.7
	0.5 10°																			
		Geometry for finish to rough machining, continuous to interrupted cuts.																		
LNMT 311240SN-R*	4.76	T9310	65	1.00	9.5	-	-	-	60	1.00	9.5	-	-	-	-	-	-	15	0.50	2.5
		T9315	70	1.00	9.5	-	-	-	65	1.00	9.5	-	-	-	-	-	-	15	0.50	2.5

* Special items



DKT(RL)-A



Basic R/L handed tool shank for KTP cartridge heads.

Suited for railway wheels returning. Available in shank size 50x55 mm. Suited for Hegenscheidt machine tools. Body treated for longer tool life.

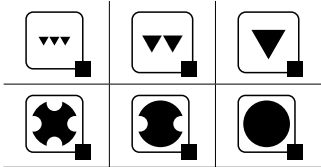
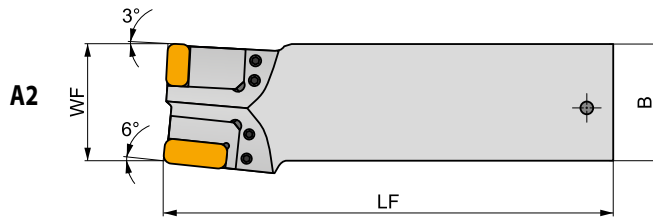
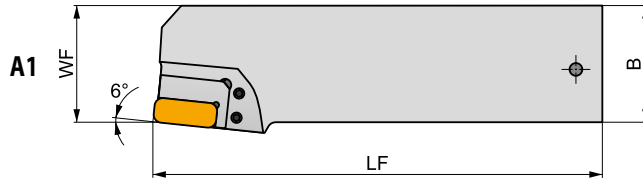
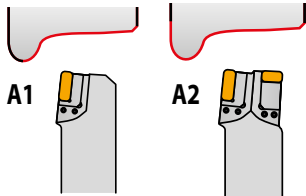
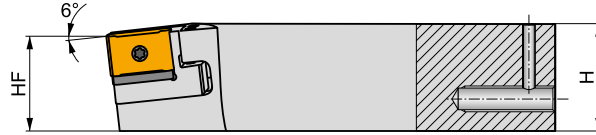

Product	H	B	LF	HF	WF	LAMS	GAMO	kg	G188	G189	G1391
	(mm)	(mm)	(mm)	(mm)	(mm)	(°)	(°)				
R DKTR 5055 X A1	50	55	210	44	55	-6	-6	3.70			
DKTR 5055 X A2	50	55	210	44	55	-6	-6	3.70			
L DKTL 5055 X A1	50	55	210	44	55	-6	-6	3.82			
DKTL 5055 X A2	50	55	210	44	55	-6	-6	3.78			

G188	KTP-LANL 19	KTP-LANL 30	KTP-SANL 19	KTP-CANL 19xx	-	-	-	-
G189	KTP-LANR 19	KTP-LANR 30	KTP-SANR 19	KTP-CANR 19xx	-	-	-	-
G1390	KTP-LANL 19	KTP-LANL 30	KTP-SANL 19	KTP-CANL 19xx	KTP-LFNR 19	KTP-SFNR 19	KTP-CFNR 19	
G1391	KTP-LANR 19	KTP-LANR 30	KTP-SANR 19	KTP-CANR 19xx	KTP-LFNL 19	KTP-SFNL 19	KTP-CFNL 19	

DKT	USS 0617	HXK 3



DKT(RL)-B



PRAMET



Basic R/L handed tool shank for KTP cartridge heads.

Suited for railway wheels returning. Available in shank size 50x49.5 mm. Suited for Rafamet UDA 125N machine tools. Body treated for longer tool life.

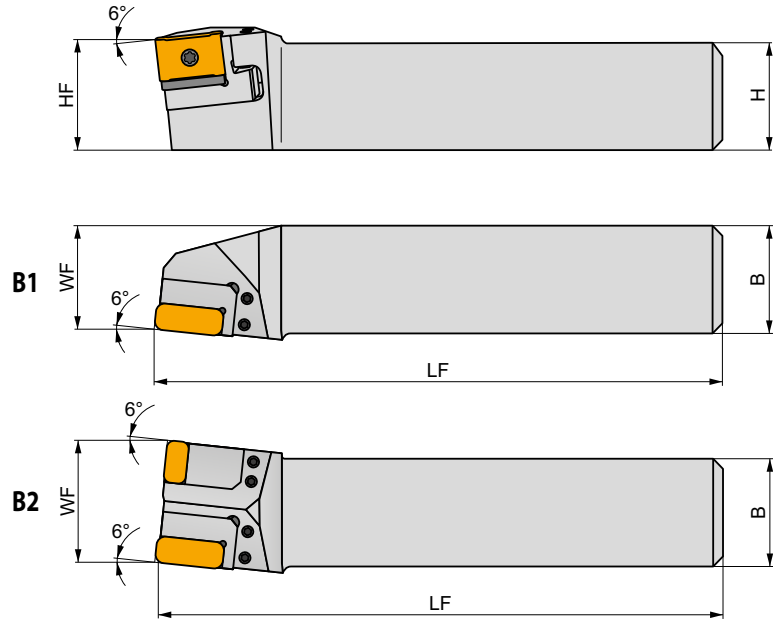
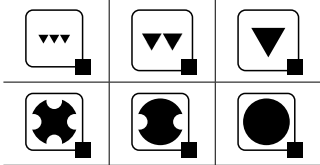
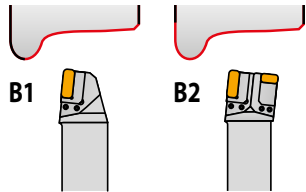

Product	H (mm)	B (mm)	LF (mm)	HF (mm)	WF (mm)	LAMS (°)	GAMO (°)	kg	GI	DKT
R DKTR 5050 X B1*	50	49.50	261	50	47	-6	-6	4.00	GI189	DKT
DKTR 5050 X B2*	50	49.50	261	50	55	-6	-6	4.00	GI391	DKT
L DKTL 5050 X B1*	50	49.50	261	50	47	-6	-6	4.00	GI188	DKT
DKTL 5050 X B2*	50	49.50	261	50	55	-6	-6	4.00	GI390	DKT

GI	KTP-LANR 19	KTP-LANR 30	KTP-SANR 19	KTP-CANR 19xx		KTP-LFNR 19	KTP-SFNR 19	KTP-CFNR 19
GI188	KTP-LANL 19	KTP-LANL 30	KTP-SANL 19	KTP-CANL 19xx	-	-	-	-
GI189	KTP-LANR 19	KTP-LANR 30	KTP-SANR 19	KTP-CANR 19xx	-	-	-	-
GI390	KTP-LANL 19	KTP-LANL 30	KTP-SANL 19	KTP-CANL 19xx	KTP-LFNR 19	KTP-SFNR 19	KTP-CFNR 19	
GI391	KTP-LANR 19	KTP-LANR 30	KTP-SANR 19	KTP-CANR 19xx	KTP-LFNL 19	KTP-SFNL 19	KTP-CFNL 19	

DKT	USS 0617	HXK 3
-----	----------	-------

* Special items



DKT(RL)-C



Basic R/L handed tool shank for KTP cartridge heads.

Suited for railway wheels returning. Available in shank size 55x55 mm and 55x52 mm. Suited for Rafamet UBB 112/2 machine tools. Body treated for longer tool life.

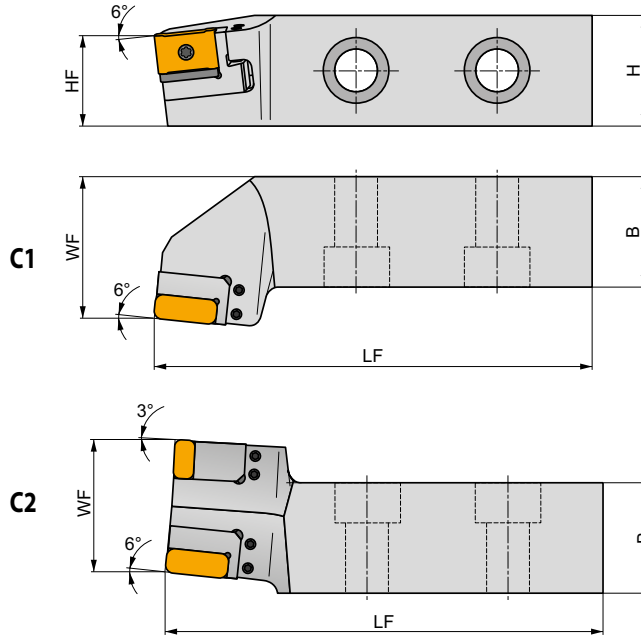
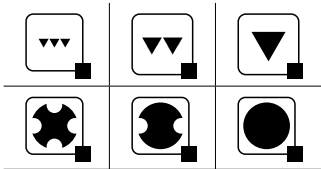
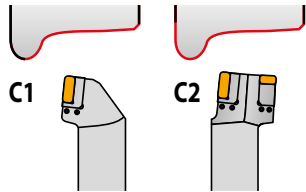

Product	H	B	LF	HF	WF	LAMS	GAMO	kg		
	(mm)	(mm)	(mm)	(mm)	(mm)	(°)	(°)			
R DKTR 5555 X C1*	55	55	217	44	70.00	-6	-6	4.10	G189	DKT
R DKTR 5555 X C2*	55	55	217	44	65.50	-6	-6	4.10	G1391	DKT
L DKTL 5555 X C1*	55	55	217	44	70.00	-6	-6	4.10	G188	DKT
L DKTL 5555 X C2*	55	55	217	44	65.50	-6	-6	4.10	G1390	DKT
R S-DKTR5552XC2-000231*	55	52	217	44	65.50	-6	-6	7.30	G1391	DKT
R S-DKTR5555XC2-000474*	55	55	217	44	70.00	-6	-6	7.70	G1391	DKT
L S-DKTL5552XC2-000230*	55	52	217	44	65.50	-6	-6	7.30	G1390	DKT
L S-DKTL5555XC2-000475*	55	55	217	44	70.00	-6	-6	7.70	G1390	DKT

G188	KTP-LANL 19	KTP-LANL 30	KTP-SANL 19	KTP-CANL 19xx	-	-	-	-
G189	KTP-LANR 19	KTP-LANR 30	KTP-SANR 19	KTP-CANR 19xx	-	-	-	-
G1390	KTP-LANL 19	KTP-LANL 30	KTP-SANL 19	KTP-CANL 19xx	KTP-LFNR 19	KTP-SFNR 19	KTP-CFNR 19	KTP-CFNR 19
G1391	KTP-LANR 19	KTP-LANR 30	KTP-SANR 19	KTP-CANR 19xx	KTP-LFNL 19	KTP-SFNL 19	KTP-CFNL 19	KTP-CFNL 19

	USS 0617	
--	----------	--

* Special items



DKT(RL)-D



Basic R/L handed tool shank for KTP cartridge heads.

Suited for railway wheels returning. Available in shank size 50x49.5 mm. Suited for Rafamet UBB 112 machine tools. Body treated for longer tool life.

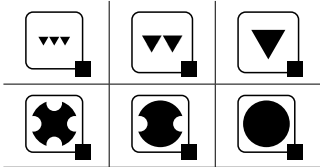
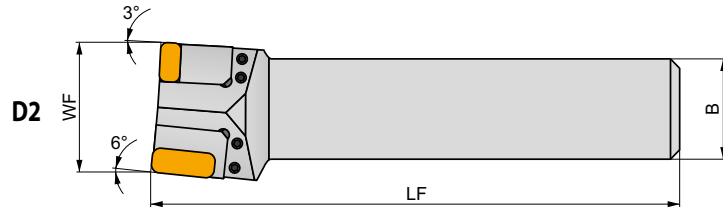
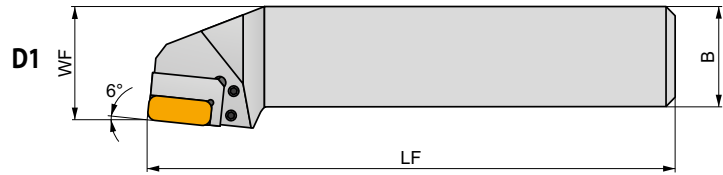
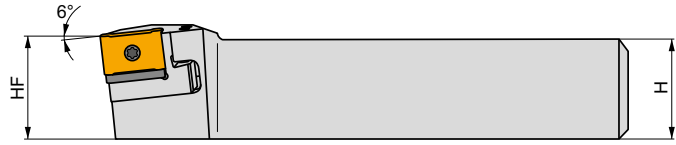
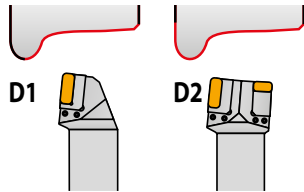

Product	H	B	LF	HF	WF	LAMS	GAMO	kg		
	(mm)	(mm)	(mm)	(mm)	(mm)	(°)	(°)			
R DKTR 5050 X D1*	50	49.5	262	50	55.50	-6	-6	4.20	G189	DKT
DKTR 5050 X D2*	50	49.5	262	50	63.00	-6	-6	4.20	G1391	DKT
L DKTL 5050 X D1*	50	49.5	262	50	55.50	-6	-6	4.20	G188	DKT
DKTL 5050 X D2*	50	49.5	262	50	63.00	-6	-6	4.20	G1390	DKT

G188	KTP-LANL 19	KTP-LANL 30	KTP-SANL 19	KTP-CANL 19xx	-	-	-	-
G189	KTP-LANR 19	KTP-LANR 30	KTP-SANR 19	KTP-CANR 19xx	-	-	-	-
G1390	KTP-LANL 19	KTP-LANL 30	KTP-SANL 19	KTP-CANL 19xx	KTP-LFNR 19	KTP-SFNR 19	KTP-CFNR 19	
G1391	KTP-LANR 19	KTP-LANR 30	KTP-SANR 19	KTP-CANR 19xx	KTP-LFNL 19	KTP-SFNL 19	KTP-CFNL 19	

DKT	USS 0617	HXK 3

* Special items



S-DKT(RL)4065X



Basic R/L handed tool shank for KTP cartridge heads or direct CNMX 19 or SNMX 19 inserts clamping.
 Suited for renovation of railway wheels. Available in shank size 40x65 mm. Body treated for longer tool life.

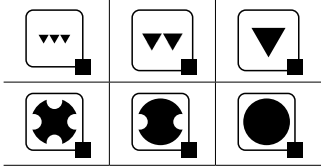
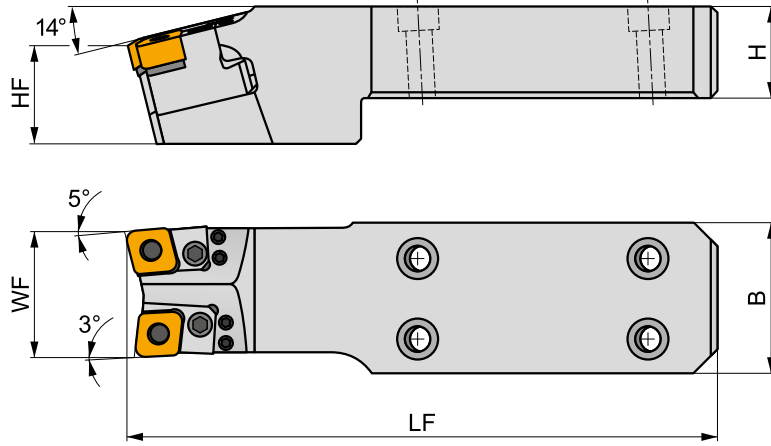
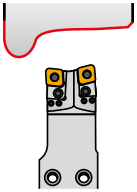

Product	H (mm)	B (mm)	LF (mm)	HF (mm)	WF (mm)	LAMS (°)	GAMO (°)	kg		
R S-DKTR4065X-000435*	40	65	255.9	22.75	54	-14	-6	4.60	GI391	USS 0617
L S-DKTL4065X-000436*	40	65	255.9	22.75	45.16	-14	-6	3.43	GI390	USS 0617

GI390	KTP-LANL 19	KTP-LANL 30	KTP-SANL 19	KTP-CANL 19xx	KTP-LFNR 19	KTP-SFNR 19	KTP-CFNR 19
GI391	KTP-LANR 19	KTP-LANR 30	KTP-SANR 19	KTP-CANR 19xx	KTP-LFNL 19	KTP-SFNL 19	KTP-CFNL 19

* Special items



S-DKT(RL)4065X-S



Basic R/L handed tool shank for SNMX 19 inserts clamping.

Suited for renovation of railway wheels. Available in shank size 40x65 mm. Body treated for longer tool life.

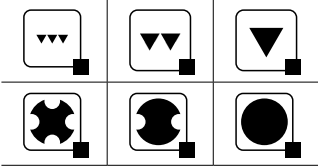
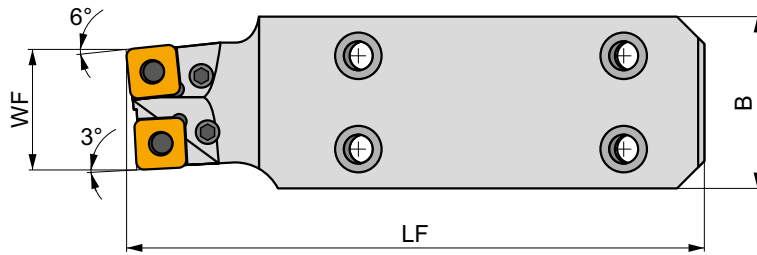
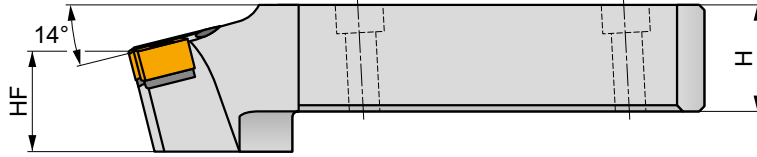
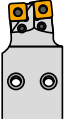

Product	H (mm)	B (mm)	LF (mm)	HF (mm)	WF (mm)	LAMS (°)	GAMO (°)	kg		
R S-DKTR4065X-000244*	40	65	217	22.1	45	-14	-6	3.71	G189	SN..1911
L S-DKTL4065X-000248*	40	65	217	22.1	45	-14	-6	3.71	G1391	SN..1911



G1277



SN..1911

C1907	CNX 19X340	PU 05	US 38	8,0	M10x1	29	NT 06	MT 06	HXK 4
C1911	CNX 19X340	PU 16	US 95	10,0	M10x1	30,5	NT 06	MT 06	HXK 4

* Special items



S-DKT(RL)5556



Basic R/L handed tool shank for KTP cartridge heads.

Suited for renovation of railway wheels. Available in shank size 56x55 mm. Body treated for longer tool life.

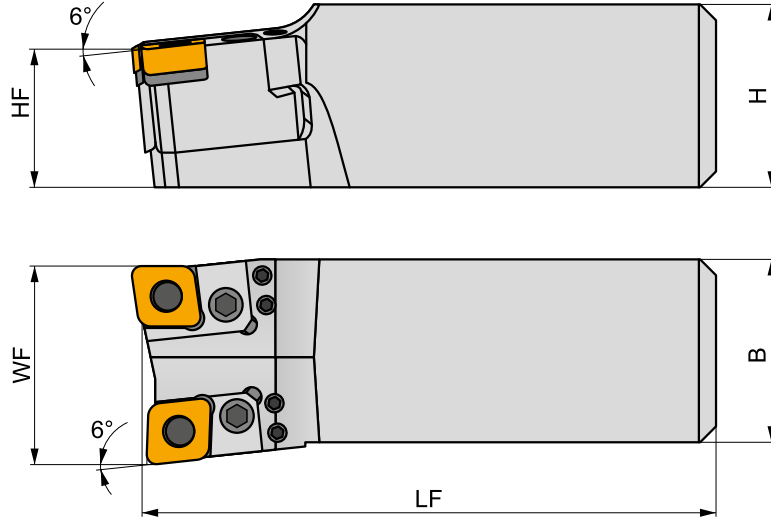
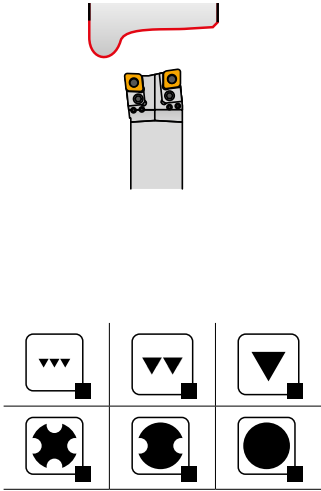

Product	H	B	LF	HF	WF	LAMS	GAMO	kg		
	(mm)	(mm)	(mm)	(mm)	(mm)	(°)	(°)			
R S-DKTR5556-000381*	56	55	176	42.3	55.5	-6	-6	3.40	G1391	DKT
L S-DKTL5556-000382*	56	55	176	42.3	55.5	-6	-6	3.40	G1390	DKT

G1390	KTP-LANL 19	KTP-LANL 30	KTP-LANR 19	KTP-CANL 19xx	KTP-LFNR 19	KTP-SFNR 19	KTP-CFNR 19						
G1391	KTP-LANR 19	KTP-LANR 30	KTP-SANR 19	KTP-CANR 19xx	KTP-LFNL 19	KTP-SFNL 19	KTP-CFNL 19						

DKT	USS 0617	HXK 3

* Special items



KTP-LAN(RL)



PRAMET



Cartridge for LN.X 19 and LN.X 30 inserts for railway wheel returning

Eccentric pin lock type R/L handed turning cartridge for negative LN.X 19 or LN.X 30 insert. For mounting on DKT tool holder. Suited for renovation of railway wheels. Tool holder treated for longer tool life.

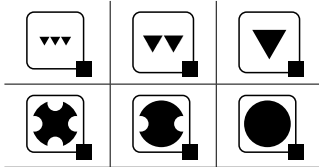
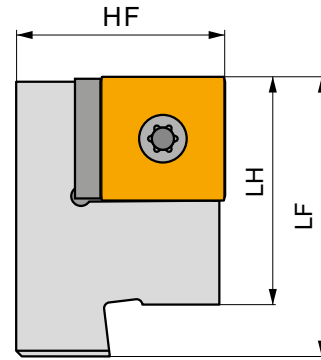
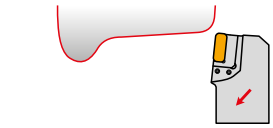

Product	HF	B	WF	LF	LH	kg		
	(mm)	(mm)	(mm)	(mm)	(mm)			
R KTP-LANR 19	32	22.6	23	43	35	0.25	GI202	LN19
KTP-LANR 30	32	22.6	23	43	35	0.17	GI200	LN30
KTP-LANR30/X-043	32	34.2	35	31	23	0.15	GI200	LN30
L KTP-LANL 19	32	22.6	23	43	35	0.25	GI202	LN19
KTP-LANL 30	32	22.6	23	43	35	0.17	GI200	LN30
KTP-LANL30/X-044	32	34.2	35	31	23	0.15	GI200	LN30

GI200	LN.X 3019..
GI202	LN.X 1919..

LN19	LNx 19T350	US 4007-T07P	UP 1515-T15P	8.0	FLAG T07P	FLAG T15P
LN30	LNx 30T350	US 4007-T07P	UP 1515-T15P	8.0	FLAG T07P	FLAG T15P



KTP-LFN(RL)



PRAMET



KTP-LFN 19

Cartridge for LN.X 19 inserts for railway wheel returning

Eccentric pin lock type R/L handed turning cartridge for negative LN.X 19. For mounting on DKT tool holder. Suited for renovation of railway wheels. Tool holder treated for longer tool life.

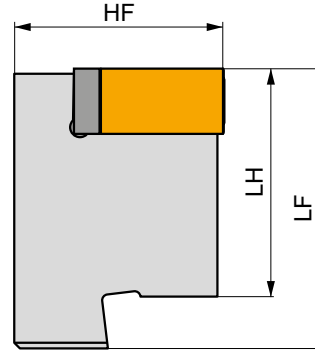
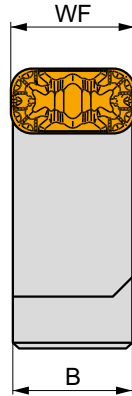
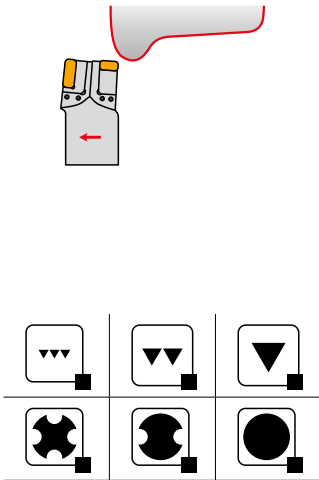

Product	≡ (mm)	B (mm)	WF (mm)	LF (mm)	LH (mm)	kg		
R KTP-LFN 19	32	18.25	19	43	35	0.15	GI202	LN19
L KTP-LFNL 19	32	18.25	19	43	35	0.15	GI202	LN19

GI202	LN.X 1919..

LN19	LN.X 19T350	US 4007-T07P	UP 1515-T15P	8.0	FLAG T07P	FLAG T15P



SN

12/ 15/ 19/ 25

CARBIDE INSERTS

SNMG



197

SNMM



201

SNMX 19



204

MATCH THE RIGHT SIZE (example)

Insert

Tool Holder

SNMG 190616E-RM

DSDNN 3232 P 19

PSBN(RL) EXT

75°

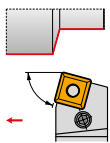

SN..

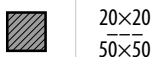
12
15
19
2520×20
50×50

206

197 – 205

KHP-SBNR + DKH(RL)

75°

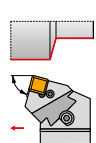

DKHR+KHP-SBNR

SN..



25

40×50
60×80

208, 210

197 – 205

KHP-SBNL + DKH(RL)

75°

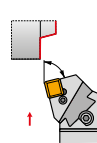

DKHR+KHP-SBNL

SN..



25

40×50
60×80

208, 210

197 – 205

KHP-SSNR/L + DKH(RL)

45°

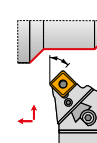

DKHR+KHP-SSNR

SN..

19
2540×50
60×80

209, 210

197 – 205

DKT(RL)-A1 + KTP



SN..



19

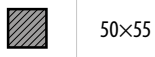

50×55

211

KTP-SAN(RL)

 197 – 205,
218

DKT(RL)-A2 + KTP



SN..



19



50×55

211

KTP-SAN(RL)
KTP-SFN(RL)
 197 – 205,
218 – 219

DKT(RL)-B1 + KTP



SN..



19



50×49.5

212

KTP-SAN(RL)

 197 – 205,
218

DKT(RL)-B2 + KTP



SN..



19

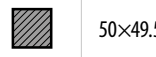

50×49.5

212

KTP-SAN(RL)
KTP-SFN(RL)
 197 – 205,
218 – 219

DKT(RL)-C1 + KTP



SN..



19



55×55

213

KTP-SAN(RL)

 197 – 205,
218

DKT(RL)-C2 + KTP



SN..

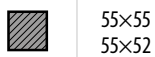

19

55×55
55×52

213

KTP-SAN(RL)
KTP-SFN(RL)
 197 – 205,
218 – 219

DKT(RL)-D1 + KTP



SN..



19

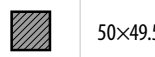

50×49.5

214

KTP-SAN(RL)

 197 – 205,
218

DKT(RL)-D2 + KTP



SN..



19

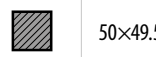







50×49.5

214

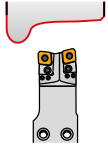





KTP-SAN(RL)
KTP-SFN(RL)
 197 – 205,
218 – 219

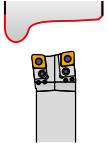

S-DKT(RL)4065X + KTP

		SN..
		
		19
		KTP-SAN(RL) KTP-SFN(RL)
	45×65	
 215	 197 – 205, 218 – 219	

S-DKT(RL)5556 + KTP

		SN..
		
		19
		KTP-SAN(RL) KTP-SFN(RL)
	56×55	
 217	 197 – 205, 218 – 219	



SNMG

	IC (mm)	D1 (mm)	L (mm)	S (mm)
1204	12.700	5.16	12.70	4.76
1506	15.875	6.35	15.88	6.35
1906	19.050	7.94	19.05	6.35
2509	25.400	9.12	25.40	9.53

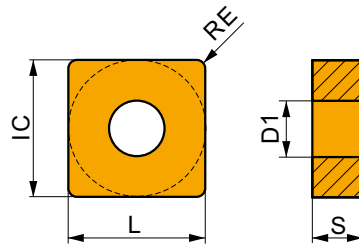

Suitability and starting values for cutting speed (vc), feed (f) and depth of cut (ap). Refer to our Machining Calculator app for further calculations.

Product	RE (mm)	P			M			K			N			S			H		
		vc (m/min)	f (mm/rev)	ap (mm)	vc (m/min)	f (mm/rev)	ap (mm)	vc (m/min)	f (mm/rev)	ap (mm)	vc (m/min)	f (mm/rev)	ap (mm)	vc (m/min)	f (mm/rev)	ap (mm)	vc (m/min)	f (mm/rev)	ap (mm)

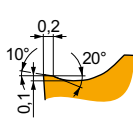

FM geometry with positive design for finish to semi-rough machining, and continuous to slightly interrupted cuts.

SNMG 120404E-FM	T6310	0.4	█	175	0.20	2.1	█	125	0.18	2.1	█	140	0.20	2.1	-	-	-	█	50	0.14	1.7	-	-	-	
	T7325	0.4	█	195	0.20	2.1	█	150	0.18	2.1	-	-	-	-	-	-	-	█	60	0.16	1.7	-	-	-	
	T8315	0.4	█	180	0.20	2.1	█	105	0.18	2.1	█	170	0.20	2.1	-	-	-	█	45	0.14	1.7	-	-	-	
	T8430	0.4	█	195	0.20	2.1	█	105	0.18	2.1	█	160	0.20	2.1	-	-	-	█	40	0.14	1.7	-	-	-	
	T9315	0.4	█	270	0.20	2.1	-	-	-	-	-	█	255	0.20	2.1	-	-	-	-	-	-	-	-	-	-
	T9325	0.4	█	240	0.20	2.1	█	140	0.18	2.1	█	225	0.20	2.1	-	-	-	█	50	0.16	1.7	-	-	-	
SNMG 120408E-FM	T7325	0.8	█	235	0.20	2.1	█	180	0.18	2.1	-	-	-	-	-	-	█	75	0.16	1.7	-	-	-		
	T8315	0.8	█	215	0.20	2.1	█	125	0.18	2.1	█	200	0.20	2.1	-	-	-	█	50	0.16	1.7	-	-	-	
	T8430	0.8	█	235	0.20	2.1	█	125	0.18	2.1	█	190	0.20	2.1	-	-	-	█	50	0.16	1.7	-	-	-	
	T9310	0.8	█	355	0.20	2.1	-	-	-	-	-	█	335	0.20	2.1	-	-	-	-	-	-	-	-	-	
	T9315	0.8	█	320	0.20	2.1	-	-	-	-	-	█	300	0.20	2.1	-	-	-	-	-	-	-	-	-	
	T9325	0.8	█	290	0.20	2.1	█	170	0.18	2.1	█	275	0.20	2.1	-	-	-	█	65	0.16	1.7	-	-	-	
SNMG 120412E-FM	T8430	1.2	█	220	0.27	2.1	█	120	0.24	2.1	█	180	0.27	2.1	-	-	-	█	45	0.19	1.7	-	-	-	
	T9315	1.2	█	300	0.27	2.1	-	-	-	-	█	285	0.27	2.1	-	-	-	-	-	-	-	-	-	-	
	T9325	1.2	█	270	0.27	2.1	█	160	0.24	2.1	█	255	0.27	2.1	-	-	-	█	60	0.19	1.7	-	-	-	
SNMG 120416E-FM	T8430	1.6	█	220	0.32	2.1	█	120	0.29	2.1	█	180	0.32	2.1	-	-	-	█	45	0.22	1.7	-	-	-	

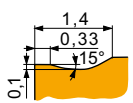

KR geometry for semi-rough to rough machining, and continuous to interrupted cuts.

SNMG 120408E-KR	T5305	0.8	█	265	0.35	3.8	-	-	-	█	250	0.35	3.8	-	-	-	-	-	-	█	50	0.18	0.7
	T5315	0.8	█	235	0.35	3.8	-	-	-	█	220	0.35	3.8	-	-	-	-	-	-	█	45	0.18	0.7
SNMG 120412E-KR	T5315	1.2	█	240	0.40	3.8	-	-	-	█	225	0.40	3.8	-	-	-	-	-	-	█	45	0.20	1.0

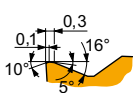

M geometry for finish to semi-rough machining, and continuous to interrupted cuts.

SNMG 120408E-M	T5305	0.8	█	290	0.32	2.1	-	-	-	█	275	0.32	2.1	-	-	-	-	-	-	█	55	0.16	0.7
	T5315	0.8	█	260	0.32	2.1	-	-	-	█	245	0.32	2.1	-	-	-	-	-	-	█	50	0.16	0.7
	T9315	0.8	█	235	0.32	2.1	-	-	-	█	220	0.32	2.1	-	-	-	-	-	-	█	45	0.16	0.7
	T9325	0.8	█	210	0.32	2.1	-	-	-	█	195	0.32	2.1	-	-	-	-	-	-	-	-	-	-
	T9335	0.8	█	185	0.32	2.1	-	-	-	-	-	-	-	-	-	-	-	-	-	-	-	-	-
SNMG 120412E-M	T9315	1.2	█	230	0.40	2.1	-	-	-	█	215	0.40	2.1	-	-	-	-	-	-	█	45	0.20	1.0
	T9325	1.2	█	200	0.40	2.1	-	-	-	█	190	0.40	2.1	-	-	-	-	-	-	-	-	-	-
	T9335	1.2	█	175	0.40	2.1	-	-	-	-	-	-	-	-	-	-	-	-	-	-	-	-	-
SNMG 120416E-M	T9325	1.6	█	210	0.40	2.1	-	-	-	█	195	0.40	2.1	-	-	-	-	-	-	-	-	-	-
SNMG 150612E-M	T9315	1.2	█	220	0.40	3.4	-	-	-	█	205	0.40	3.4	-	-	-	-	-	-	█	40	0.20	1.0
	T9325	1.2	█	195	0.40	3.4	-	-	-	█	185	0.40	3.4	-	-	-	-	-	-	-	-	-	-
	T9335	1.2	█	170	0.40	3.4	-	-	-	-	-	-	-	-	-	-	-	-	-	-	-	-	-



Suitability and starting values for cutting speed (vc), feed (f) and depth of cut (ap). Refer to our Machining Calculator app for further calculations.

Product	RE (mm)	P			M			K			N			S			H		
		vc (m/min)	f (mm/rev)	ap (mm)	vc (m/min)	f (mm/rev)	ap (mm)	vc (m/min)	f (mm/rev)	ap (mm)	vc (m/min)	f (mm/rev)	ap (mm)	vc (m/min)	f (mm/rev)	ap (mm)	vc (m/min)	f (mm/rev)	ap (mm)

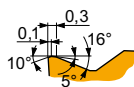

M geometry for finish to semi-rough machining, and continuous to interrupted cuts.

SNMG 190612E-M	T9315	1.2	215	0.40	4.0	-	-	-	200	0.40	4.0	-	-	-	-	-	-	40	0.20	1.0
	T9325	1.2	190	0.40	4.0	-	-	-	180	0.40	4.0	-	-	-	-	-	-	-	-	-
	T9335	1.2	165	0.40	4.0	-	-	-	-	-	-	-	-	-	-	-	-	-	-	-
SNMG 190616E-M	T9315	1.6	225	0.40	4.0	-	-	-	210	0.40	4.0	-	-	-	-	-	-	45	0.20	1.3
	T9325	1.6	200	0.40	4.0	-	-	-	190	0.40	4.0	-	-	-	-	-	-	-	-	-
	T9335	1.6	175	0.40	4.0	-	-	-	-	-	-	-	-	-	-	-	-	-	-	-

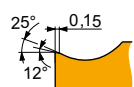

NF geometry with highly positive design for fine-finish to medium machining, and continuous cuts.

SNMG 120404E-NF	T6310	0.4	185	0.17	1.7	130	0.15	1.7	145	0.17	1.7	555	0.20	1.7	55	0.14	1.4	-	-	-
	T7335	0.4	205	0.18	1.7	155	0.16	1.7	-	-	-	-	-	-	65	0.16	1.4	-	-	-
	T8430	0.4	210	0.17	1.7	115	0.15	1.7	175	0.17	1.7	585	0.20	1.7	45	0.14	1.4	-	-	-
	T9325	0.4	260	0.18	1.7	155	0.16	1.7	245	0.18	1.7	-	-	-	55	0.16	1.4	-	-	-
SNMG 120408E-NF	HF7	0.8	-	-	-	120	0.17	1.7	190	0.19	1.7	600	0.23	1.7	-	-	-	-	-	-
	T6310	0.8	210	0.19	1.7	150	0.17	1.7	165	0.19	1.7	630	0.23	1.7	60	0.15	1.4	-	-	-
	T7325	0.8	245	0.19	1.7	190	0.17	1.7	-	-	-	-	-	75	0.15	1.4	-	-	-	
	T7335	0.8	240	0.19	1.7	185	0.17	1.7	-	-	-	-	-	75	0.15	1.4	-	-	-	
	T8315	0.8	230	0.19	1.7	135	0.17	1.7	215	0.19	1.7	690	0.23	1.7	55	0.15	1.4	-	-	-
T8430	0.8	250	0.19	1.7	135	0.17	1.7	205	0.19	1.7	690	0.23	1.7	50	0.15	1.4	-	-	-	
T9325	0.8	300	0.19	1.7	180	0.17	1.7	285	0.19	1.7	-	-	-	65	0.15	1.4	-	-	-	

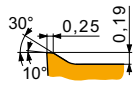

NM geometry with highly positive design for fine-finish, medium and rough machining, in continuous cuts.

SNMG 120408E-NM	T7325	0.8	225	0.25	2.1	175	0.23	2.1	-	-	-	-	-	-	70	0.20	1.7	-	-	-
	T7335	0.8	220	0.25	2.1	170	0.23	2.1	-	-	-	-	-	-	70	0.20	1.7	-	-	-
	T8430	0.8	225	0.25	2.1	120	0.23	2.1	-	-	-	615	0.30	2.1	45	0.20	1.7	-	-	-
	T9325	0.8	275	0.25	2.1	165	0.23	2.1	-	-	-	-	-	60	0.20	1.7	-	-	-	
SNMG 120412E-NM	T7325	1.2	225	0.30	2.1	175	0.27	2.1	-	-	-	-	-	-	70	0.24	1.7	-	-	-
	T7335	1.2	220	0.30	2.1	170	0.27	2.1	-	-	-	-	-	-	70	0.24	1.7	-	-	-
	T8315	1.2	215	0.30	2.1	125	0.27	2.1	-	-	-	645	0.36	2.1	50	0.24	1.7	-	-	-
	T9325	1.2	270	0.30	2.1	160	0.27	2.1	-	-	-	-	-	60	0.24	1.7	-	-	-	

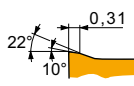

NMR geometry with positive design for medium to rough machining, and continuous cuts.

SNMG 120408E-NMR	T6310	0.8	155	0.35	2.6	110	0.32	2.6	-	-	-	-	-	-	45	0.25	2.1	-	-	-
	T7325	0.8	175	0.35	2.6	135	0.32	2.6	-	-	-	-	-	-	55	0.25	2.1	-	-	-
	T7335	0.8	165	0.35	2.6	125	0.32	2.6	-	-	-	-	-	-	50	0.25	2.1	-	-	-
	T8430	0.8	165	0.35	2.6	90	0.32	2.6	-	-	-	-	-	-	35	0.25	2.1	-	-	-
	T9325	0.8	200	0.35	2.6	120	0.32	2.6	-	-	-	-	-	-	45	0.25	2.1	-	-	-
SNMG 120412E-NMR	T6310	1.2	160	0.40	2.6	115	0.36	2.6	-	-	-	-	-	-	45	0.28	2.1	-	-	-
	T7335	1.2	165	0.40	2.6	125	0.36	2.6	-	-	-	-	-	-	50	0.28	2.1	-	-	-
	T9325	1.2	200	0.40	2.6	120	0.36	2.6	-	-	-	-	-	-	45	0.28	2.1	-	-	-
SNMG 120416E-NMR	T7325	1.6	180	0.45	2.6	140	0.41	2.6	-	-	-	-	-	-	55	0.32	2.1	-	-	-
SNMG 150612E-NMR	T6310	1.2	150	0.40	3.8	105	0.36	3.8	-	-	-	-	-	-	45	0.28	3.0	-	-	-
	T7325	1.2	170	0.40	3.8	130	0.36	3.8	-	-	-	-	-	-	55	0.28	3.0	-	-	-
	T9325	1.2	190	0.40	3.8	110	0.36	3.8	-	-	-	-	-	-	40	0.28	3.0	-	-	-
SNMG 190612E-NMR	T6310	1.2	145	0.40	5.2	100	0.36	5.2	-	-	-	-	-	-	40	0.28	4.2	-	-	-
	T7325	1.2	165	0.40	5.2	125	0.36	5.2	-	-	-	-	-	-	50	0.28	4.2	-	-	-
	T7335	1.2	155	0.40	5.2	120	0.36	5.2	-	-	-	-	-	-	50	0.28	4.2	-	-	-
	T9325	1.2	185	0.40	5.2	110	0.36	5.2	-	-	-	-	-	-	40	0.28	4.2	-	-	-



Suitability and starting values for cutting speed (vc), feed (f) and depth of cut (ap). Refer to our Machining Calculator app for further calculations.

Product	RE (mm)	P			M			K			N			S			H		
		vc (m/min)	f (mm/rev)	ap (mm)	vc (m/min)	f (mm/rev)	ap (mm)	vc (m/min)	f (mm/rev)	ap (mm)	vc (m/min)	f (mm/rev)	ap (mm)	vc (m/min)	f (mm/rev)	ap (mm)	vc (m/min)	f (mm/rev)	ap (mm)

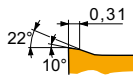

NMR geometry with positive design for medium to rough machining, and continuous cuts.

SNMG 190616E-NMR	T6310	1.6	150	0.45	5.2	105	0.41	5.2	-	-	-	-	-	-	45	0.32	4.2	-	-	-
	T7325	1.6	170	0.45	5.2	130	0.41	5.2	-	-	-	-	-	-	55	0.32	4.2	-	-	-
	T7335	1.6	155	0.45	5.2	120	0.41	5.2	-	-	-	-	-	-	50	0.32	4.2	-	-	-
	T9315	1.6	205	0.45	5.2	-	-	-	-	-	-	-	-	-	-	-	-	-	-	-

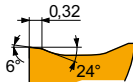

NRM geometry with positive design for semi-rough to rough machining, and continuous to moderate interrupted cuts.

SNMG 120408-NRM	T7325	0.8	175	0.35	2.6	135	0.32	2.6	-	-	-	-	-	-	55	0.28	2.1	-	-	-
SNMG 120412-NRM	T9315	1.2	220	0.40	3.0	-	-	-	-	-	-	-	-	-	-	-	-	-	-	-
SNMG 150612-NRM	T7325	1.2	170	0.40	4.0	130	0.36	4.0	-	-	-	-	-	-	55	0.32	3.2	-	-	-
SNMG 150616-NRM	T7325	1.6	170	0.45	5.0	130	0.41	5.0	-	-	-	-	-	-	55	0.36	4.0	-	-	-
	T9315	1.6	205	0.45	5.0	-	-	-	-	-	-	-	-	-	-	-	-	-	-	-
SNMG 250924-NRM	T7325	2.4	105	0.70	9.0	80	0.63	9.0	-	-	-	-	-	-	30	0.49	7.2	-	-	-
	T9315	2.4	120	0.70	9.0	-	-	-	110	0.70	9.0	-	-	-	-	-	-	-	-	-

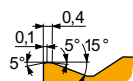

R geometry for semi-rough to rough machining, and continuous to interrupted cuts.

SNMG 120408E-R	6640	0.8	145	0.40	3.8	-	-	-	135	0.40	3.8	-	-	-	-	-	-	-	-	-
	T5305	0.8	250	0.40	3.8	-	-	-	235	0.40	3.8	-	-	-	-	-	-	50	0.20	0.7
	T9325	0.8	180	0.40	3.8	-	-	-	170	0.40	3.8	-	-	-	-	-	-	-	-	-
	T9335	0.8	155	0.40	3.8	-	-	-	-	-	-	-	-	-	-	-	-	-	-	-
SNMG 120412E-R	T9325	1.2	180	0.45	3.8	-	-	-	170	0.45	3.8	-	-	-	-	-	-	-	-	-
	T9335	1.2	160	0.45	3.8	-	-	-	-	-	-	-	-	-	-	-	-	-	-	-
SNMG 120416E-R	T9315	1.6	205	0.50	3.8	-	-	-	190	0.50	3.8	-	-	-	-	-	-	40	0.25	1.3
	T9325	1.6	185	0.50	3.8	-	-	-	175	0.50	3.8	-	-	-	-	-	-	-	-	-
SNMG 150612E-R	T5315	1.2	230	0.45	4.5	-	-	-	215	0.45	4.5	-	-	-	-	-	-	45	0.23	1.0
	T9315	1.2	200	0.45	4.5	-	-	-	190	0.45	4.5	-	-	-	-	-	-	40	0.23	1.0
	T9325	1.2	180	0.45	4.5	-	-	-	170	0.45	4.5	-	-	-	-	-	-	-	-	-
SNMG 150616E-R	T5315	1.6	230	0.50	4.5	-	-	-	215	0.50	4.5	-	-	-	-	-	-	45	0.25	1.3
	T9325	1.6	180	0.50	4.5	-	-	-	170	0.50	4.5	-	-	-	-	-	-	-	-	-
SNMG 190612E-R	6640	1.2	140	0.45	6.0	-	-	-	130	0.45	6.0	-	-	-	-	-	-	-	-	-
	T9315	1.2	195	0.45	6.0	-	-	-	185	0.45	6.0	-	-	-	-	-	-	35	0.23	1.0
	T9325	1.2	175	0.45	6.0	-	-	-	165	0.45	6.0	-	-	-	-	-	-	-	-	-
SNMG 190616E-R	T9310	1.6	205	0.50	6.0	-	-	-	190	0.50	6.0	-	-	-	-	-	-	40	0.25	1.3
	T9315	1.6	195	0.50	6.0	-	-	-	185	0.50	6.0	-	-	-	-	-	-	35	0.25	1.3
	T9325	1.6	175	0.50	6.0	-	-	-	165	0.50	6.0	-	-	-	-	-	-	-	-	-
	T9335	1.6	150	0.50	6.0	-	-	-	-	-	-	-	-	-	-	-	-	-	-	-

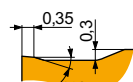

RM geometry for semi-rough to rough machining, and continuous to interrupted cuts.

SNMG 120408E-RM	T5305	0.8	290	0.40	4.0	-	-	-	275	0.40	4.0	-	-	-	-	-	-	-	-	-
	T5315	0.8	260	0.40	4.0	-	-	-	245	0.40	4.0	-	-	-	-	-	-	-	-	-
	T6310	0.8	165	0.40	4.0	115	0.36	4.0	130	0.40	4.0	-	-	-	-	-	-	-	-	-
	T7325	0.8	185	0.40	4.0	140	0.36	4.0	-	-	-	-	-	-	-	-	-	-	-	-
	T7335	0.8	175	0.40	4.0	135	0.36	4.0	-	-	-	-	-	-	-	-	-	-	-	-
	T8315	0.8	175	0.40	4.0	105	0.36	4.0	165	0.40	4.0	-	-	-	-	-	-	-	-	-
	T8430	0.8	175	0.40	4.0	95	0.36	4.0	140	0.40	4.0	-	-	-	-	-	-	-	-	-
	T9315	0.8	235	0.40	4.0	-	-	-	220	0.40	4.0	-	-	-	-	-	-	-	-	-
	T9325	0.8	210	0.40	4.0	125	0.36	4.0	195	0.40	4.0	-	-	-	-	-	-	-	-	-
	T9335	0.8	180	0.40	4.0	105	0.36	4.0	-	-	-	-	-	-	-	-	-	-	-	-



Suitability and starting values for cutting speed (vc), feed (f) and depth of cut (ap). Refer to our Machining Calculator app for further calculations.

Product	RE (mm)	P			M			K			N			S			H		
		vc (m/min)	f (mm/rev)	ap (mm)	vc (m/min)	f (mm/rev)	ap (mm)	vc (m/min)	f (mm/rev)	ap (mm)	vc (m/min)	f (mm/rev)	ap (mm)	vc (m/min)	f (mm/rev)	ap (mm)	vc (m/min)	f (mm/rev)	ap (mm)

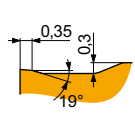

RM geometry for semi-rough to rough machining, and continuous to interrupted cuts.

SNMG 120412E-RM	T5315	1.2	265	0.45	4.0	-	-	-	250	0.45	4.0	-	-	-	-	-	-	-	-
	T6310	1.2	165	0.45	4.0	115	0.41	4.0	130	0.45	4.0	-	-	-	-	-	-	-	-
	T7325	1.2	190	0.45	4.0	145	0.41	4.0	-	-	-	-	-	-	-	-	-	-	-
	T7335	1.2	180	0.45	4.0	140	0.41	4.0	-	-	-	-	-	-	-	-	-	-	-
	T9315	1.2	235	0.45	4.0	-	-	-	220	0.45	4.0	-	-	-	-	-	-	-	-
	T9325	1.2	210	0.45	4.0	125	0.41	4.0	195	0.45	4.0	-	-	-	-	-	-	-	-
	T9335	1.2	185	0.45	4.0	110	0.41	4.0	-	-	-	-	-	-	-	-	-	-	-
SNMG 120416E-RM	T5315	1.6	270	0.50	4.0	-	-	-	255	0.50	4.0	-	-	-	-	-	-	-	-
	T7335	1.6	180	0.50	4.0	140	0.45	4.0	-	-	-	-	-	-	-	-	-	-	
	T8430	1.6	175	0.50	4.0	95	0.45	4.0	140	0.50	4.0	-	-	-	-	-	-	-	
	T9315	1.6	230	0.50	4.0	-	-	-	215	0.50	4.0	-	-	-	-	-	-	-	
	T9325	1.6	215	0.50	4.0	125	0.45	4.0	200	0.50	4.0	-	-	-	-	-	-	-	
SNMG 150612E-RM	T5315	1.2	255	0.45	5.0	-	-	-	240	0.45	5.0	-	-	-	-	-	-	-	-
	T6310	1.2	165	0.45	5.0	115	0.41	5.0	130	0.45	5.0	-	-	-	-	-	-	-	
	T7325	1.2	185	0.45	5.0	140	0.41	5.0	-	-	-	-	-	-	-	-	-	-	
	T9315	1.2	225	0.45	5.0	-	-	-	210	0.45	5.0	-	-	-	-	-	-	-	
	T9325	1.2	205	0.45	5.0	120	0.41	5.0	190	0.45	5.0	-	-	-	-	-	-	-	
	T9335	1.2	180	0.45	5.0	105	0.41	5.0	-	-	-	-	-	-	-	-	-	-	
SNMG 150616E-RM	T7335	1.6	175	0.50	5.0	135	0.45	5.0	-	-	-	-	-	-	-	-	-	-	
	T9315	1.6	230	0.50	5.0	-	-	-	215	0.50	5.0	-	-	-	-	-	-	-	
	T9325	1.6	205	0.50	5.0	120	0.45	5.0	190	0.50	5.0	-	-	-	-	-	-		
	T9335	1.6	180	0.50	5.0	105	0.45	5.0	-	-	-	-	-	-	-	-	-		
SNMG 190612E-RM	T5305	1.2	275	0.45	7.0	-	-	-	260	0.45	7.0	-	-	-	-	-	-	-	
	T5315	1.2	250	0.45	7.0	-	-	-	235	0.45	7.0	-	-	-	-	-	-	-	
	T7325	1.2	180	0.45	7.0	140	0.41	7.0	-	-	-	-	-	-	-	-	-		
	T7335	1.2	165	0.45	7.0	125	0.41	7.0	-	-	-	-	-	-	-	-	-		
	T9315	1.2	220	0.45	7.0	-	-	-	205	0.45	7.0	-	-	-	-	-	-	-	
	T9325	1.2	195	0.45	7.0	115	0.41	7.0	185	0.45	7.0	-	-	-	-	-	-		
	T9335	1.2	175	0.45	7.0	105	0.41	7.0	-	-	-	-	-	-	-	-	-		
SNMG 190616E-RM	T5305	1.6	285	0.50	7.0	-	-	-	270	0.50	7.0	-	-	-	-	-	-	-	
	T5315	1.6	250	0.50	7.0	-	-	-	235	0.50	7.0	-	-	-	-	-	-	-	
	T6310	1.6	160	0.50	7.0	115	0.45	7.0	125	0.50	7.0	-	-	-	-	-	-		
	T7335	1.6	170	0.50	7.0	130	0.45	7.0	-	-	-	-	-	-	-	-	-		
	T9315	1.6	220	0.50	7.0	-	-	-	205	0.50	7.0	-	-	-	-	-	-		
	T9325	1.6	200	0.50	7.0	120	0.45	7.0	190	0.50	7.0	-	-	-	-	-	-		
	T9335	1.6	175	0.50	7.0	105	0.45	7.0	-	-	-	-	-	-	-	-	-		
SNMG 250924E-RM	T7325	2.4	110	0.80	12.0	85	0.72	12.0	-	-	-	-	-	-	-	-	-		
	T7335	2.4	105	0.80	12.0	80	0.72	12.0	-	-	-	-	-	-	-	-	-		
	T9226	2.4	95	0.80	12.0	55	0.72	12.0	90	0.80	12.0	-	-	-	-	-			
	T9315	2.4	125	0.80	12.0	-	-	-	115	0.80	12.0	-	-	-	-	-			
	T9325	2.4	110	0.80	12.0	65	0.72	12.0	100	0.80	12.0	-	-	-	-	-			
T9335	2.4	90	0.80	12.0	50	0.72	12.0	-	-	-	-	-	-	-	-				

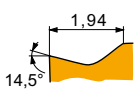

SF geometry with positive design for fine-finish machining of thin walls and continuous cuts.

SNMG 120408E-SF	H07	0.8	-	-	-	105	0.18	1.0	165	0.20	1.0	525	0.24	1.0	50	0.14	0.8	-	-
	T6310	0.8	210	0.20	1.0	150	0.18	1.0	165	0.20	1.0	630	0.24	1.0	60	0.14	0.8	40	0.10
	T8430	0.8	245	0.20	1.0	135	0.18	1.0	200	0.20	1.0	675	0.24	1.0	50	0.14	0.8	40	0.10
	T9325	0.8	295	0.20	1.0	175	0.18	1.0	280	0.20	1.0	-	-	-	65	0.16	0.8	-	-
SNMG 120412E-SF	T6310	1.2	200	0.25	1.5	140	0.23	1.5	160	0.25	1.5	600	0.30	1.5	60	0.18	1.2	40	0.13
	T8430	1.2	225	0.25	1.5	120	0.23	1.5	185	0.25	1.5	615	0.30	1.5	45	0.18	1.2	35	0.13



Suitability and starting values for cutting speed (vc), feed (f) and depth of cut (ap). Refer to our Machining Calculator app for further calculations.

Product	RE (mm)	P			M			K			N			S			H		
		vc (m/min)	f (mm/rev)	ap (mm)	vc (m/min)	f (mm/rev)	ap (mm)	vc (m/min)	f (mm/rev)	ap (mm)	vc (m/min)	f (mm/rev)	ap (mm)	vc (m/min)	f (mm/rev)	ap (mm)	vc (m/min)	f (mm/rev)	ap (mm)

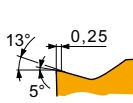

SM geometry with positive design for medium machining and continuous to interrupted cuts.

SNMG 120408E-SM	T6310	0.8	185	0.25	1.8	130	0.23	1.8	145	0.25	1.8	555	0.30	1.8	55	0.20	1.4	35	0.13	0.7
	T7325	0.8	210	0.25	1.8	160	0.23	1.8	-	-	-	-	-	-	65	0.20	1.4	-	-	-
	T7335	0.8	205	0.25	1.8	155	0.23	1.8	-	-	-	-	-	-	65	0.20	1.4	-	-	-
	T8430	0.8	205	0.25	1.8	110	0.23	1.8	170	0.25	1.8	570	0.30	1.8	45	0.20	1.4	35	0.13	0.7
	T9315	0.8	280	0.25	1.8	-	-	-	265	0.25	1.8	-	-	-	-	-	-	55	0.13	0.7
SNMG 120412E-SM	T7325	1.2	210	0.30	1.8	160	0.27	1.8	-	-	-	-	-	-	65	0.24	1.4	-	-	-
	T9315	1.2	275	0.30	1.8	-	-	-	260	0.30	1.8	-	-	-	-	-	55	0.15	1.0	
SNMG 190612E-SM	T6310	1.2	175	0.30	4.0	125	0.27	4.0	140	0.30	4.0	525	0.36	4.0	50	0.27	3.2	35	0.15	1.0
	T7325	1.2	195	0.30	4.0	150	0.27	4.0	-	-	-	-	-	-	60	0.27	3.2	-	-	-
	T9325	1.2	230	0.30	4.0	135	0.27	4.0	215	0.30	4.0	-	-	-	50	0.27	3.2	-	-	-
SNMG 190616E-SM	T7335	1.6	175	0.40	4.0	135	0.36	4.0	-	-	-	-	-	-	55	0.32	3.2	-	-	-
	T9325	1.6	210	0.40	4.0	125	0.36	4.0	195	0.40	4.0	-	-	-	45	0.32	3.2	-	-	-

SNMM



	IC (mm)	D1 (mm)	L (mm)	S (mm)
1204	12.700	5.16	12.70	4.76
1506	15.875	6.35	15.88	6.35
1906	19.050	7.94	19.05	6.35
2507	25.400	9.12	25.40	7.94
2509	25.400	9.12	25.40	9.53

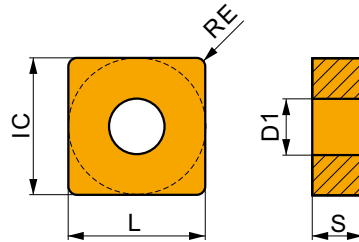

Suitability and starting values for cutting speed (vc), feed (f) and depth of cut (ap). Refer to our Machining Calculator app for further calculations.

Product	RE (mm)	P			M			K			N			S			H		
		vc (m/min)	f (mm/rev)	ap (mm)	vc (m/min)	f (mm/rev)	ap (mm)	vc (m/min)	f (mm/rev)	ap (mm)	vc (m/min)	f (mm/rev)	ap (mm)	vc (m/min)	f (mm/rev)	ap (mm)	vc (m/min)	f (mm/rev)	ap (mm)

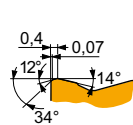

HR geometry for rough to heavy-rough machining, and continuous to interrupted cuts.

SNMM 190616E-HR	T8345	1.6	60	0.60	9.0	35	0.54	9.0	55	0.60	9.0	-	-	-	-	-	-	-	-	-
	T9325	1.6	110	0.60	9.0	65	0.54	9.0	100	0.60	9.0	-	-	-	-	-	-	-	-	-
	T9335	1.6	85	0.60	9.0	50	0.54	9.0	-	-	-	-	-	-	-	-	-	-	-	-
SNMM 190624E-HR	T8345	2.4	60	0.65	9.0	35	0.59	9.0	55	0.65	9.0	-	-	-	-	-	-	-	-	-
	T9315	2.4	120	0.65	9.0	-	-	-	110	0.65	9.0	-	-	-	-	-	-	-	-	-
	T9325	2.4	115	0.65	9.0	65	0.59	9.0	105	0.65	9.0	-	-	-	-	-	-	-	-	-
SNMM 250716E-HR	T8345	1.6	60	0.60	13.0	35	0.54	13.0	55	0.60	13.0	-	-	-	-	-	-	-	-	-
	T9325	1.6	100	0.60	13.0	60	0.54	13.0	95	0.60	13.0	-	-	-	-	-	-	-	-	-
	T9335	1.6	85	0.60	13.0	50	0.54	13.0	-	-	-	-	-	-	-	-	-	-	-	-
SNMM 250724E-HR	6630	2.4	90	0.65	13.0	50	0.59	13.0	85	0.65	13.0	-	-	-	-	-	-	-	-	-
	6640	2.4	80	0.65	13.0	45	0.59	13.0	75	0.65	13.0	-	-	-	-	-	-	-	-	-
	T8345	2.4	55	0.65	13.0	30	0.59	13.0	50	0.65	13.0	-	-	-	-	-	-	-	-	-
	T9315	2.4	120	0.65	13.0	-	-	-	110	0.65	13.0	-	-	-	-	-	-	-	-	-
	T9325	2.4	105	0.65	13.0	60	0.59	13.0	95	0.65	13.0	-	-	-	-	-	-	-	-	-
	T9335	2.4	85	0.65	13.0	50	0.59	13.0	-	-	-	-	-	-	-	-	-	-	-	-
SNMM 250732E-HR	T9325	3.2	95	0.80	13.0	55	0.72	13.0	90	0.80	13.0	-	-	-	-	-	-	-	-	-



Suitability and starting values for cutting speed (vc), feed (f) and depth of cut (ap). Refer to our Machining Calculator app for further calculations.

Product	RE (mm)	P			M			K			N			S			H		
		vc (m/min)	f (mm/rev)	ap (mm)	vc (m/min)	f (mm/rev)	ap (mm)	vc (m/min)	f (mm/rev)	ap (mm)	vc (m/min)	f (mm/rev)	ap (mm)	vc (m/min)	f (mm/rev)	ap (mm)	vc (m/min)	f (mm/rev)	ap (mm)

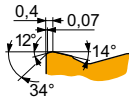

HR geometry for rough to heavy-rough machining, and continuous to interrupted cuts.

SNMM 250924E-HR	6630	2.4	90	0.65	13.0	50	0.59	13.0	85	0.65	13.0	-	-	-	-	-	-	-
	T8345	2.4	55	0.65	13.0	30	0.59	13.0	50	0.65	13.0	-	-	-	-	-	-	-
	T9315	2.4	120	0.65	13.0	-	-	-	110	0.65	13.0	-	-	-	-	-	-	-
	T9325	2.4	105	0.65	13.0	60	0.59	13.0	95	0.65	13.0	-	-	-	-	-	-	-
	T9335	2.4	85	0.65	13.0	50	0.59	13.0	-	-	-	-	-	-	-	-	-	-
SNMM 250932E-HR	T9325	3.2	95	0.80	13.0	55	0.72	13.0	90	0.80	13.0	-	-	-	-	-	-	-

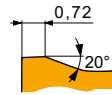

HR2 geometry for rough to heavy-rough machining, and continuous to interrupted cuts.

SNMM 190616-HR2	T9315	1.6	115	0.65	8.9	-	-	-	105	0.65	8.9	-	-	-	-	-	-	-
	T9335	1.6	85	0.65	8.9	50	0.59	8.9	-	-	-	-	-	-	-	-	-	-
SNMM 190624-HR2	T9315	2.4	105	0.85	8.9	-	-	-	95	0.85	8.9	-	-	-	-	-	-	-
	T9335	2.4	80	0.85	8.9	45	0.77	8.9	-	-	-	-	-	-	-	-	-	-
SNMM 250724-HR2	T9226	2.4	85	0.85	11.0	50	0.77	11.0	80	0.85	11.0	-	-	-	-	-	-	-
	T9335	2.4	80	0.85	11.0	45	0.77	11.0	-	-	-	-	-	-	-	-	-	-
SNMM 250924-HR2	T9226	2.4	85	0.85	11.0	50	0.77	11.0	80	0.85	11.0	-	-	-	-	-	-	-
	T9315	2.4	105	0.85	11.0	-	-	-	95	0.85	11.0	-	-	-	-	-	-	-
	T9335	2.4	80	0.85	11.0	45	0.77	11.0	-	-	-	-	-	-	-	-	-	-
SNMM 250932-HR2	T9315	3.2	95	1.00	11.0	-	-	-	90	1.00	11.0	-	-	-	-	-	-	-
	T9335	3.2	75	1.00	11.0	45	0.90	11.0	-	-	-	-	-	-	-	-	-	-

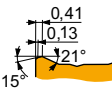

NR2 geometry for semi-rough to rough machining, and continuous to interrupted cuts.

SNMM 120408E-NR2	T7325	0.8	175	0.40	4.7	135	0.36	4.7	-	-	-	55	0.32	3.8	-	-	-
	T7335	0.8	170	0.40	4.7	130	0.36	4.7	-	-	-	55	0.32	3.8	-	-	-
	T8430	0.8	165	0.40	4.7	90	0.36	4.7	135	0.40	4.7	35	0.32	3.8	-	-	-
	T9325	0.8	195	0.40	4.7	115	0.36	4.7	185	0.40	4.7	40	0.32	3.8	-	-	-
SNMM 120412E-NR2	T7335	1.2	165	0.45	4.7	125	0.41	4.7	-	-	-	50	0.36	3.8	-	-	-
	T8430	1.2	165	0.45	4.7	90	0.41	4.7	135	0.45	4.7	35	0.36	3.8	-	-	-
	T9325	1.2	200	0.45	4.7	120	0.41	4.7	190	0.45	4.7	45	0.36	3.8	-	-	-
SNMM 150612E-NR2	T7335	1.2	165	0.45	6.0	125	0.41	6.0	-	-	-	50	0.36	4.8	-	-	-
	T8430	1.2	165	0.45	6.0	90	0.41	6.0	135	0.45	6.0	35	0.36	4.8	-	-	-
	T9325	1.2	195	0.45	6.0	115	0.41	6.0	185	0.45	6.0	40	0.36	4.8	-	-	-
SNMM 150616E-NR2	T7335	1.6	165	0.50	6.0	125	0.45	6.0	-	-	-	50	0.40	4.8	-	-	-
	T9325	1.6	190	0.50	6.0	110	0.45	6.0	180	0.50	6.0	40	0.40	4.8	-	-	-
SNMM 190612E-NR2	T7335	1.2	160	0.45	8.0	120	0.41	8.0	-	-	-	50	0.36	6.4	-	-	-
	T9325	1.2	190	0.45	8.0	110	0.41	8.0	180	0.45	8.0	40	0.36	6.4	-	-	-
SNMM 190616E-NR2	T7325	1.6	175	0.50	8.0	135	0.45	8.0	-	-	-	55	0.40	6.4	-	-	-
	T7335	1.6	160	0.50	8.0	120	0.45	8.0	-	-	-	50	0.40	6.4	-	-	-
	T8430	1.6	155	0.50	8.0	85	0.45	8.0	130	0.50	8.0	30	0.40	6.4	-	-	-
	T9315	1.6	210	0.50	8.0	-	-	-	195	0.50	8.0	-	-	-	-	-	-
	T9325	1.6	185	0.50	8.0	110	0.45	8.0	175	0.50	8.0	40	0.40	6.4	-	-	-
SNMM 190624E-NR2	T7325	2.4	155	0.80	8.0	120	0.72	8.0	-	-	-	50	0.56	6.4	-	-	-
	T7335	2.4	145	0.80	8.0	110	0.72	8.0	-	-	-	45	0.56	6.4	-	-	-
	T9325	2.4	165	0.80	8.0	95	0.72	8.0	155	0.80	8.0	35	0.56	6.4	-	-	-
SNMM 250724E-NR2	T7335	2.4	100	0.80	12.0	75	0.72	12.0	-	-	-	30	0.56	9.6	-	-	-
	T8430	2.4	85	0.80	12.0	45	0.72	12.0	70	0.80	12.0	15	0.56	9.6	-	-	-
	T9226	2.4	95	0.80	12.0	55	0.72	12.0	90	0.80	12.0	20	0.56	9.6	-	-	-
	T9315	2.4	120	0.80	12.0	-	-	-	110	0.80	12.0	-	-	-	-	-	-
	T9325	2.4	105	0.80	12.0	60	0.72	12.0	95	0.80	12.0	20	0.56	9.6	-	-	-



Suitability and starting values for cutting speed (vc), feed (f) and depth of cut (ap). Refer to our Machining Calculator app for further calculations.

Product	RE (mm)	P			M			K			N			S			H		
		vc (m/min)	f (mm/rev)	ap (mm)	vc (m/min)	f (mm/rev)	ap (mm)	vc (m/min)	f (mm/rev)	ap (mm)	vc (m/min)	f (mm/rev)	ap (mm)	vc (m/min)	f (mm/rev)	ap (mm)	vc (m/min)	f (mm/rev)	ap (mm)

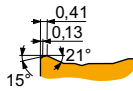

NR2 geometry for semi-rough to rough machining, and continuous to interrupted cuts.

SNMM 250924E-NR2	T7325	2.4	105	0.80	12.0	80	0.72	12.0	-	-	-	-	-	30	0.56	9.6	-	-	-	
	T7335	2.4	100	0.80	12.0	75	0.72	12.0	-	-	-	-	-	30	0.56	9.6	-	-	-	
	T9226	2.4	95	0.80	12.0	55	0.72	12.0	90	0.80	12.0	-	-	20	0.56	9.6	-	-	-	
	T9315	2.4	120	0.80	12.0	-	-	-	110	0.80	12.0	-	-	-	-	-	-	-	-	-
	T9325	2.4	105	0.80	12.0	60	0.72	12.0	95	0.80	12.0	-	-	20	0.56	9.6	-	-	-	

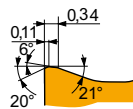

NRM geometry with positive design for semi-rough to rough machining, and continuous to moderate interrupted cuts.

SNMM 250724-NRM	T9315	2.4	120	0.65	9.0	-	-	-	110	0.65	9.0	-	-	-	-	-	-	-	-
SNMM 250924-NRM	T7325	2.4	105	0.70	9.0	80	0.63	9.0	-	-	-	-	-	30	0.49	7.2	-	-	-
	T7335	2.4	95	0.70	9.0	70	0.63	9.0	-	-	-	-	-	30	0.49	7.2	-	-	-

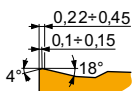

OR geometry for semi-rough to rough machining, and continuous to interrupted cuts.

SNMM 120408E-OR	T9315	0.8	220	0.40	4.7	-	-	-	205	0.40	4.7	-	-	-	-	-	-	-	-
	T9325	0.8	195	0.40	4.7	115	0.36	4.7	185	0.40	4.7	-	-	40	0.32	3.8	-	-	-
	T9335	0.8	175	0.40	4.7	105	0.36	4.7	-	-	-	-	-	35	0.32	3.8	-	-	-
SNMM 120412E-OR	T9315	1.2	225	0.45	4.7	-	-	-	210	0.45	4.7	-	-	-	-	-	-	-	-
	T9325	1.2	200	0.45	4.7	120	0.41	4.7	190	0.45	4.7	-	-	45	0.36	3.8	-	-	-
SNMM 120416E-OR	T9325	1.6	200	0.50	4.7	120	0.45	4.7	190	0.50	4.7	-	-	45	0.40	3.8	-	-	-
SNMM 150608E-OR	T9325	0.8	190	0.40	6.0	110	0.36	6.0	180	0.40	6.0	-	-	40	0.36	4.8	-	-	-
SNMM 150612E-OR	T9325	1.2	195	0.45	6.0	115	0.41	6.0	185	0.45	6.0	-	-	40	0.36	4.8	-	-	-
SNMM 150616E-OR	T9315	1.6	215	0.50	6.0	-	-	-	200	0.50	6.0	-	-	-	-	-	-	-	-
	T9325	1.6	190	0.50	6.0	110	0.45	6.0	180	0.50	6.0	-	-	40	0.40	4.8	-	-	-
	T9335	1.6	160	0.50	6.0	95	0.45	6.0	-	-	-	-	-	35	0.40	6.4	-	-	-
SNMM 190612E-OR	T8430	1.2	150	0.45	8.0	80	0.41	8.0	125	0.45	8.0	-	-	30	0.36	6.4	-	-	-
	T9315	1.2	210	0.45	8.0	-	-	-	195	0.45	8.0	-	-	-	-	-	-	-	-
	T9325	1.2	190	0.45	8.0	110	0.41	8.0	180	0.45	8.0	-	-	40	0.36	6.4	-	-	-
	T9335	1.2	165	0.45	8.0	95	0.41	8.0	-	-	-	-	-	35	0.36	6.4	-	-	-
SNMM 190616E-OR	T8345	1.6	125	0.50	8.0	75	0.45	8.0	115	0.50	8.0	-	-	30	0.40	6.4	-	-	-
	T8430	1.6	155	0.50	8.0	85	0.45	8.0	130	0.50	8.0	-	-	30	0.40	6.4	-	-	-
	T9315	1.6	210	0.50	8.0	-	-	-	195	0.50	8.0	-	-	-	-	-	-	-	-
	T9325	1.6	185	0.50	8.0	110	0.45	8.0	175	0.50	8.0	-	-	40	0.40	6.4	-	-	-
SNMM 190624E-OR	T9335	1.6	160	0.50	8.0	95	0.45	8.0	-	-	-	-	-	35	0.40	6.4	-	-	-
	T9315	2.4	180	0.80	8.0	-	-	-	170	0.80	8.0	-	-	-	-	-	-	-	-
SNMM 250716E-OR	T9325	2.4	165	0.80	8.0	95	0.72	8.0	155	0.80	8.0	-	-	35	0.56	6.4	-	-	-
	T9226	1.6	115	0.50	12.0	65	0.45	12.0	105	0.50	12.0	-	-	20	0.45	9.6	-	-	-
	T9325	1.6	120	0.55	12.0	70	0.50	12.0	110	0.55	12.0	-	-	25	0.50	9.6	-	-	-
SNMM 250724E-OR	6630	2.4	85	1.00	12.0	50	0.90	12.0	80	1.00	12.0	-	-	20	0.70	9.6	-	-	-
	T8345	2.4	55	1.00	12.0	30	0.90	12.0	50	1.00	12.0	-	-	10	0.70	9.6	-	-	-
	T8430	2.4	80	1.00	12.0	45	0.90	12.0	65	1.00	12.0	-	-	15	0.70	9.6	-	-	-
	T9315	2.4	105	1.00	12.0	-	-	-	95	1.00	12.0	-	-	-	-	-	-	-	-
	T9325	2.4	100	1.00	12.0	60	0.90	12.0	95	1.00	12.0	-	-	20	0.70	9.6	-	-	-
	T9335	2.4	80	1.00	12.0	45	0.90	12.0	-	-	-	-	-	15	0.70	9.6	-	-	-
	T9315	2.4	105	1.00	12.0	-	-	-	95	1.00	12.0	-	-	-	-	-	-	-	-
SNMM 250924E-OR	T8430	2.4	80	1.00	12.0	45	0.90	12.0	65	1.00	12.0	-	-	15	0.70	9.6	-	-	-
	T9226	2.4	85	1.00	12.0	50	0.90	12.0	80	1.00	12.0	-	-	15	0.70	9.6	-	-	-
	T9315	2.4	105	1.00	12.0	-	-	-	95	1.00	12.0	-	-	-	-	-	-	-	-
	T9325	2.4	100	1.00	12.0	60	0.90	12.0	95	1.00	12.0	-	-	20	0.70	9.6	-	-	-
	T9335	2.4	80	1.00	12.0	45	0.90	12.0	-	-	-	-	-	15	0.70	9.6	-	-	-



Suitability and starting values for cutting speed (vc), feed (f) and depth of cut (ap). Refer to our Machining Calculator app for further calculations.

Product	RE (mm)	P			M			K			N			S			H		
		vc (m/min)	f (mm/rev)	ap (mm)	vc (m/min)	f (mm/rev)	ap (mm)	vc (m/min)	f (mm/rev)	ap (mm)	vc (m/min)	f (mm/rev)	ap (mm)	vc (m/min)	f (mm/rev)	ap (mm)	vc (m/min)	f (mm/rev)	ap (mm)

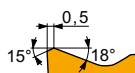

SR geometry for rough to heavy-rough machining, and continuous to interrupted cuts.

SNMM 250724S-SR	T9325	2.4	80	1.00	12.0	45	0.90	12.0	75	1.00	12.0	-	-	-	-	-	-	-
SNMM 250924S-SR	6630	2.4	65	1.00	14.0	35	0.90	14.0	60	1.00	14.0	-	-	-	-	-	-	-
	T9335	2.4	65	1.00	14.0	35	0.90	14.0	-	-	-	-	-	-	-	-	-	-

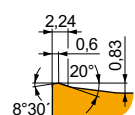

Geometry 923 for semi-rough to heavy-rough machining, and continuous to heavy interrupted cuts.

SNMM 190616S-923	T8345	1.6	100	0.65	8.9	60	0.59	8.9	95	0.65	8.9	-	-	-	25	0.52	7.1	-	-	-
	T8430	1.6	125	0.65	8.9	65	0.59	8.9	100	0.65	8.9	-	-	-	25	0.52	7.1	-	-	-
	T9335	1.6	130	0.65	8.9	75	0.59	8.9	-	-	-	-	-	-	25	0.52	7.1	-	-	-
SNMM 250724S-923	T8430	2.4	80	0.85	11.0	45	0.77	11.0	65	0.85	11.0	-	-	-	15	0.60	8.8	-	-	-
	T9335	2.4	80	0.85	11.0	45	0.77	11.0	-	-	-	-	-	-	15	0.60	8.8	-	-	-
SNMM 250924S-923	T8345	2.4	55	0.85	11.0	30	0.77	11.0	50	0.85	11.0	-	-	-	10	0.60	8.8	-	-	-
	T8430	2.4	80	0.85	11.0	45	0.77	11.0	65	0.85	11.0	-	-	-	15	0.60	8.8	-	-	-
	T9226	2.4	85	0.85	11.0	50	0.77	11.0	80	0.85	11.0	-	-	-	15	0.60	8.8	-	-	-
	T9315	2.4	105	0.85	11.0	-	-	-	95	0.85	11.0	-	-	-	-	-	-	-	-	-
	T9335	2.4	80	0.85	11.0	45	0.77	11.0	-	-	-	-	-	-	15	0.60	8.8	-	-	-

SNMX 19

PRAMET

	IC (mm)	D1 (mm)	L (mm)	S (mm)
1906	19.050	6.35	19.05	6.35
1911	19.050	7.75	19.05	11.00

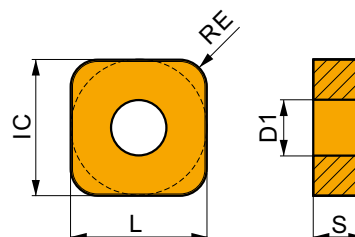

Suitability and starting values for cutting speed (vc), feed (f) and depth of cut (ap). Refer to our Machining Calculator app for further calculations.

Product	RE (mm)	P			M			K			N			S			H		
		vc (m/min)	f (mm/rev)	ap (mm)	vc (m/min)	f (mm/rev)	ap (mm)	vc (m/min)	f (mm/rev)	ap (mm)	vc (m/min)	f (mm/rev)	ap (mm)	vc (m/min)	f (mm/rev)	ap (mm)	vc (m/min)	f (mm/rev)	ap (mm)

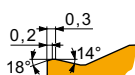

RF geometry for semi-rough to rough machining, and continuous to interrupted cuts.

SNMX 191140SN-RF	T9315	4.0	105	0.75	5.5	-	-	-	95	0.75	5.5	-	-	-	-	-	-	-	
S-SNMX190640SN-RF*	T5315	4.0	80	0.85	4.5	-	-	-	75	0.85	4.0	-	-	-	-	-	15	0.43	2.7

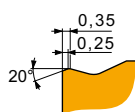



TF geometry for semi-rough to rough machining, and continuous to interrupted cuts.

SNMX 191140SN-TF	T5315	4.0	85	0.80	5.5	-	-	-	80	0.80	5.5	-	-	-	-	-	15	0.40	2.7
	T9315	4.0	80	0.80	5.5	-	-	-	75	0.80	5.5	-	-	-	-	-	15	0.40	2.7
	T9325	4.0	75	0.80	5.5	-	-	-	70	0.80	5.5	-	-	-	-	-	-	-	-

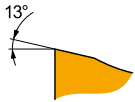

Suitability and starting values for cutting speed (vc), feed (f) and depth of cut (ap). Refer to our Machining Calculator app for further calculations.

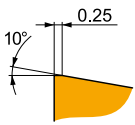
Product	RE (mm)	P			M			K			N			S			H			
		vc (m/min)	f (mm/rev)	ap (mm)	vc (m/min)	f (mm/rev)	ap (mm)	vc (m/min)	f (mm/rev)	ap (mm)	vc (m/min)	f (mm/rev)	ap (mm)	vc (m/min)	f (mm/rev)	ap (mm)	vc (m/min)	f (mm/rev)	ap (mm)	
  TF1 geometry for finish to semi-rough machining, continuous to interrupted cuts.																				
S-SNMX 190640SN-TF1*	T9315	4.0	80	0.85	2.0	-	-	-	75	0.85	2.0	-	-	-	-	-	-	15	0.40	1.5
  TF2 geometry for finish to semi-rough machining, continuous to interrupted cuts.																				
S-SNMX 190640SN-TF2*	T9315	4.0	80	0.85	2.0	-	-	-	75	0.85	2.0	-	-	-	-	-	-	15	0.40	1.5

* Special items



PSBN(RL) EXT

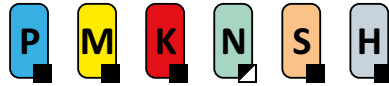

PRAMET

P



External Lever Lock Holder with 75° Cutting Angle for SN.. Insert

External Right/Left hand lever lock tool holder with 75° cutting angle. Suited for longitudinal turning without shoulder, taper turning and chamfering with negative SN.. 12, 15, 19 or 25 size inserts. Available in 20x20 up to 50x50 mm shank. Body treated for longer tool life.

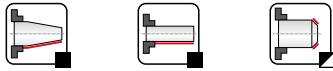
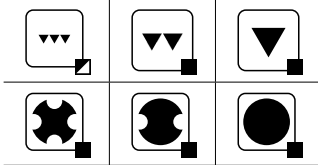
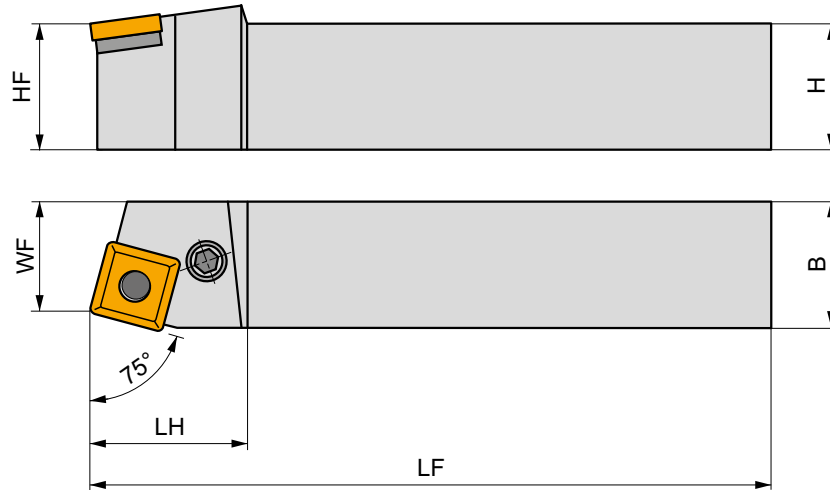
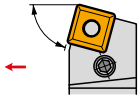

Product	∅	B	HF	WF	LF	LH	LAMS	GAMO	kg		
	(mm)	(mm)	(mm)	(mm)	(mm)	(mm)	(°)	(°)			
R PSBNR 2020 K 12	20	20	20	17	125	36	-6	-6	0.42	G1029	PS22
PSBNR 2525 M 12	25	25	25	22	150	36	-6	-6	0.75	G1029	PS20
PSBNR 3225 P 15	32	25	32	22	170	40	-6	-6	1.05	G1082	PS40
PSBNR 3232 P 19	32	32	32	27	170	45	-6	-6	1.30	G1026	PS50
PSBNR 4040 R 19	40	40	40	35	200	45	-6	-6	2.40	G1026	PS50
PSBNR 4040 S 19	40	40	40	35	250	45	-6	-6	3.12	G1026	PS50
PSBNR 4040 R 25	40	40	40	35	200	45	-6	-6	2.45	G1027	PS60
PSBNR 4040 S 25	40	40	40	35	250	50	-6	-6	2.85	G1027	PS60
PSBNR 4040 S 2509	40	40	40	35	250	50	-6	-6	2.50	G1040	PS70
PSBNR 4040 S 2512-A	40	40	40	35	250	50	-6	-6	3.08	G1162	PS72
PSBNR 5050 S 25	50	50	50	43	250	50	-6	-6	4.70	G1027	PS60
PSBNR 5050 T 25	50	50	50	43	300	50	-6	-6	5.83	G1027	PS60
PSBNR 5050 T 2509	50	50	50	43	300	50	-6	-6	5.50	G1040	PS70
PSBNR 5050 T 2512-A	50	50	50	43	300	50	-6	-6	5.83	G1162	PS72
L PSBNL 2020 K 12	20	20	20	17	125	36	-6	-6	0.42	G1029	PS22
PSBNL 2525 M 12	25	25	25	22	150	36	-6	-6	0.75	G1029	PS20
PSBNL 3225 P 15	32	25	32	22	170	40	-6	-6	1.05	G1082	PS40
PSBNL 3232 P 19	32	32	32	27	170	45	-6	-6	1.35	G1026	PS50
PSBNL 4040 R 19	40	40	40	35	200	45	-6	-6	2.50	G1026	PS50
PSBNL 4040 S 19	40	40	40	35	250	45	-6	-6	3.13	G1026	PS50
PSBNL 4040 R 25	40	40	40	35	200	45	-6	-6	2.45	G1027	PS60
PSBNL 4040 S 25	40	40	40	35	250	50	-6	-6	3.10	G1027	PS60
PSBNL 4040 S 2509	40	40	40	35	250	50	-6	-6	2.50	G1040	PS70
PSBNL 4040 S 2512-A	40	40	40	35	250	50	-6	-6	3.11	G1162	PS72
PSBNL 5050 S 25	50	50	50	43	250	50	-6	-6	4.70	G1027	PS60
PSBNL 5050 T 25	50	50	50	43	300	50	-6	-6	5.84	G1027	PS60
PSBNL 5050 T 2509	50	50	50	43	300	50	-6	-6	5.80	G1040	PS70

BN

CN

DN

LN

SN

TN

VN

WN



Product	H	B	HF	WF	LF	LH	LAMS	GAMO			
	(mm)	(mm)	(mm)	(mm)	(mm)	(mm)	(°)	(°)			
L PSBNL 5050 T 2512-A	50	50	50	43	300	50	-6	-6	5.82	G162	PS72

GI026	SN.. 1906..
GI027	SN.. 2507..
GI029	SN.. 1204..
GI040	SN.. 2509..
GI082	SN.. 1506..
GI162	SN.. 2512..

PS20	SNU 120312	PU 02	US 35	6.0	M 8x1	22.5	NT 05	MT 05	HXK 4
PS22	SNU 120312	PU 02	US 42	6.0	M 8x1	21	NT 05	MT 05	HXK 4
PS40	SNU 150312	PU 04	US 36	6.0	M 8x1	26	NT 07	MT 07	HXK 4
PS50	SNU 190416	PU 05	US 38	8.0	M 10x1	29	NT 06	MT 06	HXK 5
PS60	SNU 250624	PU 06	US 39	8.0	M 10x1	33	NT 08	MT 08	HXK 5
PS70	SNU 250624	PU 06	US 47	8.0	M 12x1	36	NT 08	MT 08	HXK 5
PS72	SNU 250624	PU 10-N	PS 12040	8.0	M 12x1	40	NT 08	MT 08	HXK 5



KHP-SBN(RL)



PRAMET

P



Modular KHP Lever Lock Turning Cartridge, 75° Cutting Angle for SN.. Inserts

Dovetailed Right/Left hand lever lock turning cartridge, 75° Cutting Angle, for mounting on DKH tool holder shank. Suited for heavy longitudinal turning without shoulder, face turning, taper and chamfer turning with negative SN.. 19 or 25 inserts. Tool holder treated for longer tool life.

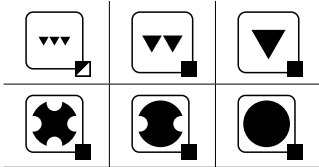
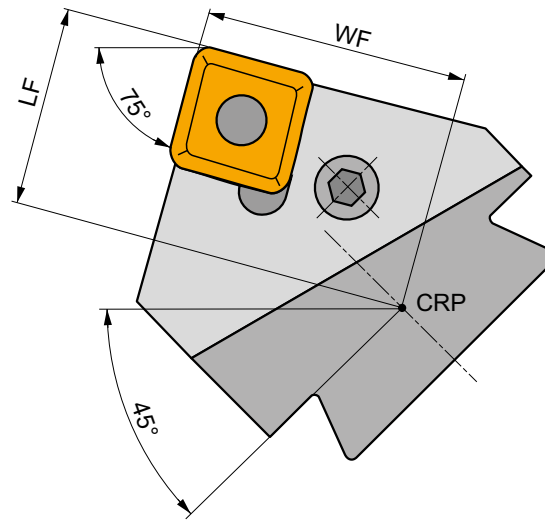
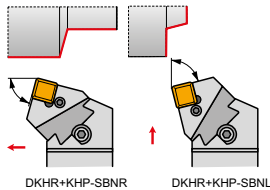

Product	WF (mm)	LF (mm)	LAMS (°)	GAMO (°)	kg		
R KHP-SBNR 19	47	36	-6	-6	1.51	GI026	PS50
KHP-SBNR 25	47	36	-6	-6	1.47	GI027	PS60
KHP-SBNR 2509	47	36	-6	-6	1.45	GI040	PS70
KHP-SBNR 2512-A	47	36	-6	-6	1.71	GI162	PS72
L KHP-SBNL 19	47	36	-6	-6	1.51	GI026	PS50
KHP-SBNL 25	47	36	-6	-6	1.47	GI027	PS60
KHP-SBNL 2509	47	36	-6	-6	1.45	GI040	PS70
KHP-SBNL 2512-A	47	36	-6	-6	1.71	GI162	PS72

		SN..
GI026		SN.. 1906..
GI027		SN.. 2507..
GI040		SN.. 2509..
GI162		SN.. 2512..

PS50	SNU 190416	PU 05	US 38	8.0	M 10x1	29	NT 06	MT 06	HXK 5
PS60	SNU 250624	PU 06	US 39	8.0	M 10x1	33	NT 08	MT 08	HXK 5
PS70	SNU 250624	PU 06	US 47	8.0	M 12x1	36	NT 08	MT 08	HXK 5
PS72	SNU 250624	PU 10-N	PS 12040	8.0	M 12x1	40	NT 08	MT 08	HXK 5



KHP-SSN(RL)



PRAMET

P



Modular KHP Lever Lock Turning Cartridge, 45° Cutting Angle for SN.. Inserts

Dovetailed Right/Left hand lever lock turning cartridge, 45° Cutting Angle, for mounting on DKH tool holder shank. Suited for heavy longitudinal turning without shoulder, face turning, copy, taper and chamfer turning with negative SN.. 19 or 25 inserts. Tool holder treated for longer tool life.

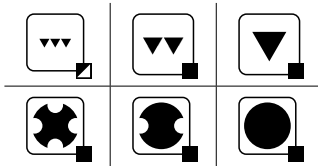
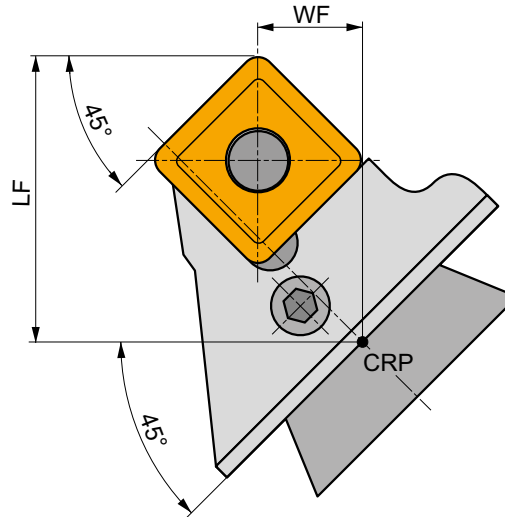
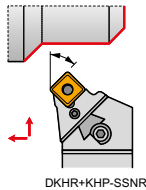

Product	WF	LF	LAMS	GAMO	kg		
	(mm)	(mm)	(°)	(°)			
R KHP-SSNR 19	15	45	-6	-6	1.28	GI026	PS50
	KHP-SSNR 25	15	45	-6	-6	0.98	GI027
L KHP-SSNL 19	15	45	-6	-6	1.03	GI026	PS50
	KHP-SSNL 25	15	45	-6	-6	1.30	GI027

GI026		SN.. 1906..
GI027		SN.. 2507..

PS50	SNU 190416	PU 05	US 38	8.0	M 10x1	29	NT 06	MT 06	HXX 5
PS60	SNU 250624	PU 06	US 39	8.0	M 10x1	33	NT 08	MT 08	HXX 5



DKH(RL)



External Tool Holder Shank for KHP/KHS Heavy Turning Cartridges

Dovetailed Right/Left hand modular tool shank for KHP/KHS cartridges. Suited for heavy turning applications. Available with shank size 40x50 up to 60x80 mm. Body treated for longer tool life.

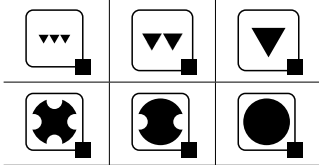
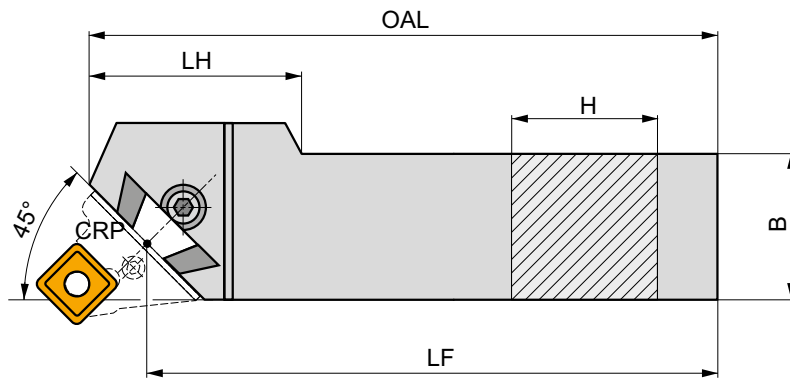
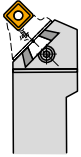

Product	H	B	LF	OAL	LH	kg		
	(mm)	(mm)	(mm)	(mm)	(mm)			
R DKHR 4050 V	40	50	400	425	100	7.10	GI098	DKH10
DKHR 5060 W	50	60	450	475	110	11.30	GI098	DKH10
DKHR 6080 W-A	60	80	450	485	90	19.65	GI098	DKH10
L DKHL 4050 V	40	50	400	425	100	7.10	GI098	DKH10
DKHL 5060 W	50	60	450	475	110	11.30	GI098	DKH10
DKHL 6080 W-A	60	80	450	485	90	19.65	GI098	DKH10



GI098



KHP



KHS



DKH10



SR 14



HXK 10



DKT(RL)-A



Basic R/L handed tool shank for KTP cartridge heads.

Suited for railway wheels returning. Available in shank size 50x55 mm. Suited for Hegenscheidt machine tools. Body treated for longer tool life.

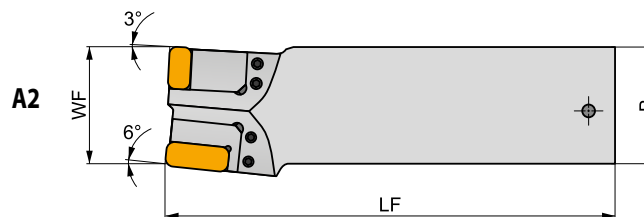
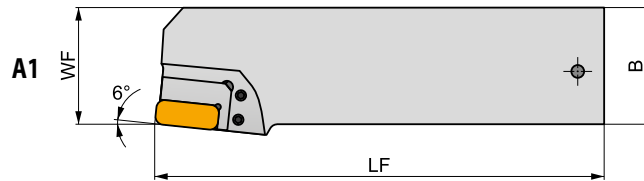
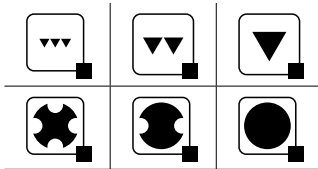
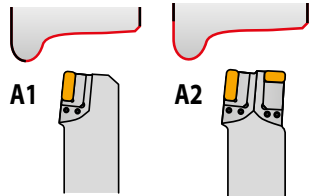

Product	H	B	LF	HF	WF	LAMS	GAMO	kg		
	(mm)	(mm)	(mm)	(mm)	(mm)	(°)	(°)			
R DKTR 5055 X A1	50	55	210	44	55	-6	-6	3.70	GI189	DKT
DKTR 5055 X A2	50	55	210	44	55	-6	-6	3.70	GI391	DKT
L DKTL 5055 X A1	50	55	210	44	55	-6	-6	3.82	GI188	DKT
DKTL 5055 X A2	50	55	210	44	55	-6	-6	3.78	GI390	DKT

GI188	KTP-LANL 19	KTP-LANL 30	KTP-SANL 19	KTP-CANL 19xx	-	-	-
GI189	KTP-LANR 19	KTP-LANR 30	KTP-SANR 19	KTP-CANR 19xx	-	-	-
GI390	KTP-LANL 19	KTP-LANL 30	KTP-SANL 19	KTP-CANL 19xx	KTP-LFNR 19	KTP-SFNR 19	KTP-CFNR 19
GI391	KTP-LANR 19	KTP-LANR 30	KTP-SANR 19	KTP-CANR 19xx	KTP-LFNL 19	KTP-SFNL 19	KTP-CFNL 19

DKT	USS 0617					HXK 3



DKT(RL)-B



Basic R/L handed tool shank for KTP cartridge heads.

Suited for railway wheels returning. Available in shank size 50x49.5 mm. Suited for Rafamet UDA 125N machine tools. Body treated for longer tool life.

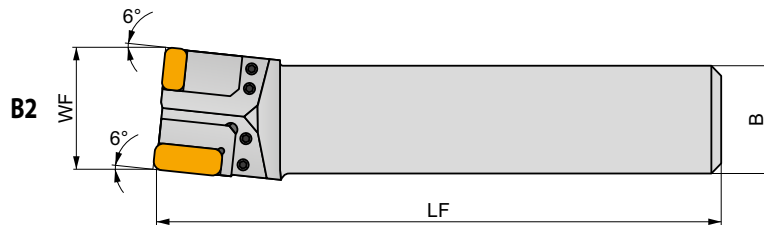
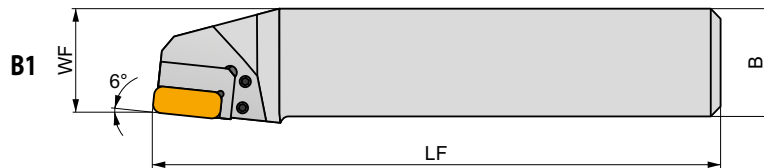
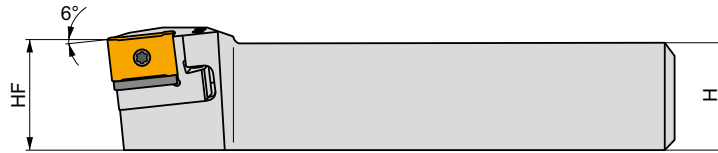
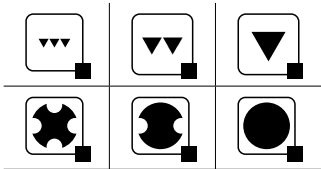
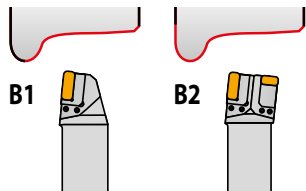

Product	H	B	LF	HF	WF	LAMS	GAMO	kg		
	(mm)	(mm)	(mm)	(mm)	(mm)	(°)	(°)			
R DKTR 5050 X B1*	50	49.50	261	50	47	-6	-6	4.00	G189	DKT
DKTR 5050 X B2*	50	49.50	261	50	55	-6	-6	4.00	G1391	DKT
L DKTL 5050 X B1*	50	49.50	261	50	47	-6	-6	4.00	G188	DKT
DKTL 5050 X B2*	50	49.50	261	50	55	-6	-6	4.00	G1390	DKT

G188	KTP-LANL 19	KTP-LANL 30	KTP-SANL 19	KTP-CANL 19xx	-	-	-
G189	KTP-LANR 19	KTP-LANR 30	KTP-SANR 19	KTP-CANR 19xx	-	-	-
G1390	KTP-LANL 19	KTP-LANL 30	KTP-SANL 19	KTP-CANL 19xx	KTP-LFNR 19	KTP-SFNR 19	KTP-CFNR 19
G1391	KTP-LANR 19	KTP-LANR 30	KTP-SANR 19	KTP-CANR 19xx	KTP-LFNL 19	KTP-SFNL 19	KTP-CFNL 19

DKT	USS 0617	HXK 3

* Special items



DKT(RL)-C



Basic R/L handed tool shank for KTP cartridge heads.

Suited for railway wheels returning. Available in shank size 55x55 mm and 55x52 mm. Suited for Rafamet UBB 112/2 machine tools. Body treated for longer tool life.

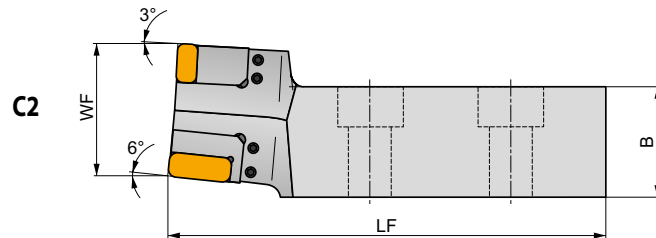
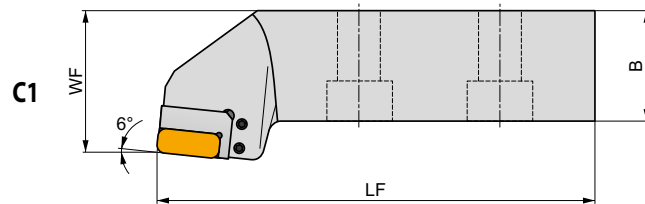
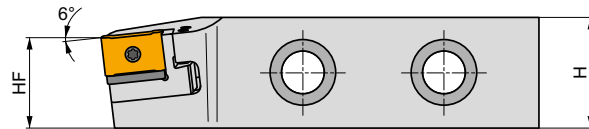
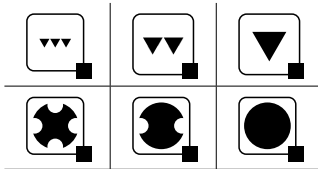
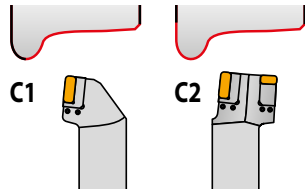

Product	H	B	LF	HF	WF	LAMS	GAMO	kg		
	(mm)	(mm)	(mm)	(mm)	(mm)	(°)	(°)			
R DKTR 5555 X C1*	55	55	217	44	70.00	-6	-6	4.10	G189	DKT
R DKTR 5555 X C2*	55	55	217	44	65.50	-6	-6	4.10	G188	DKT
L DKTL 5555 X C1*	55	55	217	44	70.00	-6	-6	4.10	G188	DKT
L DKTL 5555 X C2*	55	55	217	44	65.50	-6	-6	4.10	G189	DKT
R S-DKTR5552XC2-000231*	55	52	217	44	65.50	-6	-6	7.30	G189	DKT
R S-DKTR5555XC2-000474*	55	55	217	44	70.00	-6	-6	7.70	G189	DKT
L S-DKTL5552XC2-000230*	55	52	217	44	65.50	-6	-6	7.30	G189	DKT
L S-DKTL5555XC2-000475*	55	55	217	44	70.00	-6	-6	7.70	G189	DKT

G188	KTP-LANL 19	KTP-LANL 30	KTP-SANL 19	KTP-CANL 19xx	-	-	-	-	-
G189	KTP-LANR 19	KTP-LANR 30	KTP-SANR 19	KTP-CANR 19xx	-	-	-	-	-
G1390	KTP-LANL 19	KTP-LANL 30	KTP-SANL 19	KTP-CANL 19xx	KTP-LFNR 19	KTP-SFNR 19	KTP-CFNR 19	KTP-CFNR 19	KTP-CFNR 19
G1391	KTP-LANR 19	KTP-LANR 30	KTP-SANR 19	KTP-CANR 19xx	KTP-LFNL 19	KTP-SFNL 19	KTP-CFNL 19	KTP-CFNL 19	KTP-CFNL 19

DKT	USS 0617	HXK 3

* Special items



DKT(RL)-D



PRAMET

Basic R/L handed tool shank for KTP cartridge heads.

Suited for railway wheels returning. Available in shank size 50x49.5 mm. Suited for Rafamet UBB 112 machine tools. Body treated for longer tool life.

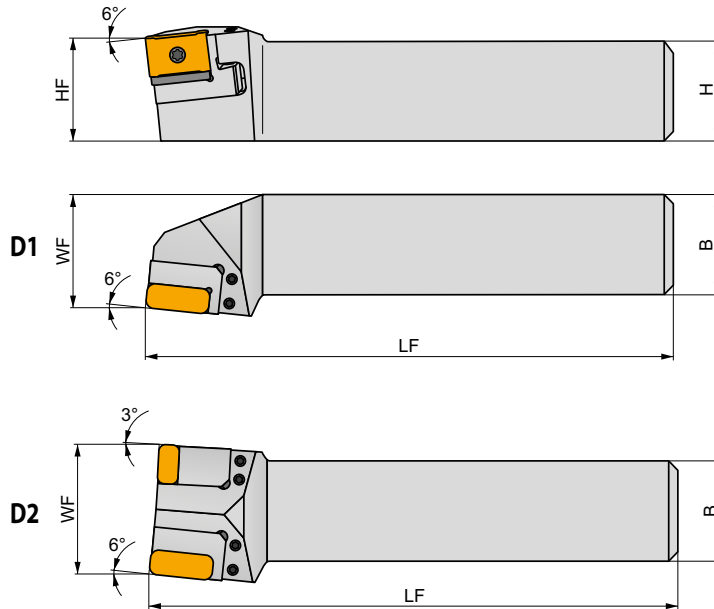
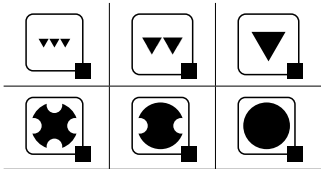
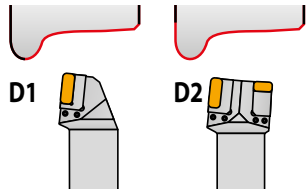

Product	H	B	LF	HF	WF	LAMS	GAMO	kg		
	(mm)	(mm)	(mm)	(mm)	(mm)	(°)	(°)			
R DKTR 5050 X D1*	50	49.5	262	50	55.50	-6	-6	4.20		GI189 DKT
DKTR 5050 X D2*	50	49.5	262	50	63.00	-6	-6	4.20		GI391 DKT
L DKTL 5050 X D1*	50	49.5	262	50	55.50	-6	-6	4.20		GI188 DKT
DKTL 5050 X D2*	50	49.5	262	50	63.00	-6	-6	4.20		GI390 DKT

GI188	KTP-LANL 19	KTP-LANL 30	KTP-SANL 19	KTP-CANL 19xx	-	-	-
GI189	KTP-LANR 19	KTP-LANR 30	KTP-SANR 19	KTP-CANR 19xx	-	-	-
GI390	KTP-LANL 19	KTP-LANL 30	KTP-SANL 19	KTP-CANL 19xx	KTP-LFNR 19	KTP-SFNR 19	KTP-CFNR 19
GI391	KTP-LANR 19	KTP-LANR 30	KTP-SANR 19	KTP-CANR 19xx	KTP-LFNL 19	KTP-SFNL 19	KTP-CFNL 19

DKT	USS 0617	HXK 3

* Special items



S-DKT(RL)4065X



Basic R/L handed tool shank for KTP cartridge heads or direct CNMX 19 or SNMX 19 inserts clamping.
Suited for renovation of railway wheels. Available in shank size 40x65 mm. Body treated for longer tool life.

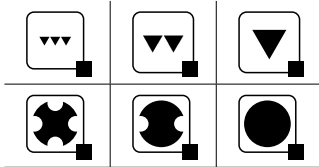
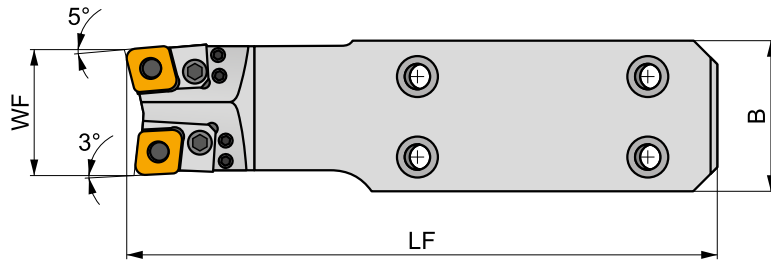
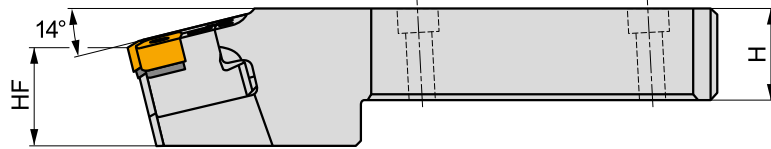
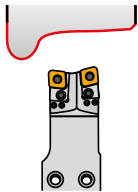

Product	H (mm)	B (mm)	LF (mm)	HF (mm)	WF (mm)	LAMS (°)	GAMO (°)	kg		
R S-DKTR4065X-000435*	40	65	255.9	22.75	54	-14	-6	4.60	G1391	USS 0617
L S-DKTL4065X-000436*	40	65	255.9	22.75	45.16	-14	-6	3.43	G1390	USS 0617

G1390	KTP-LANL 19	KTP-LANL 30	KTP-SANL 19	KTP-CANL 19xx	KTP-LFNR 19	KTP-SFNR 19	KTP-CFNR 19
G1391	KTP-LANR 19	KTP-LANR 30	KTP-SANR 19	KTP-CANR 19xx	KTP-LFNL 19	KTP-SFNL 19	KTP-CFNL 19

* Special items



S-DKT(RL)4065X-S



Basic R/L handed tool shank for SNMX 19 inserts clamping.

Suited for renovation of railway wheels. Available in shank size 40x65 mm. Body treated for longer tool life.

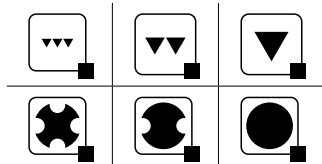
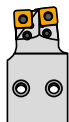
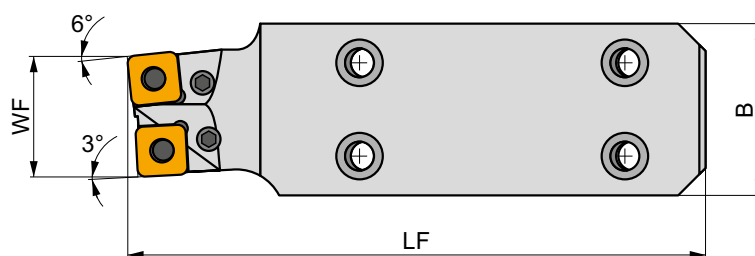
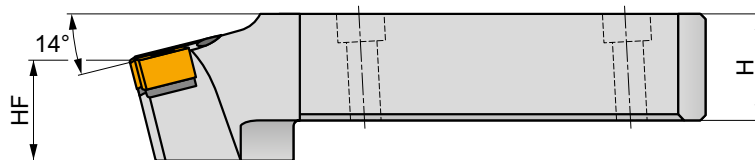

Product	H (mm)	B (mm)	LF (mm)	HF (mm)	WF (mm)	LAMS (°)	GAMO (°)	kg		
R S-DKTR4065X-000244*	40	65	217	22.1	45	-14	-6	3.71	G189	SN..1911
L S-DKTL4065X-000248*	40	65	217	22.1	45	-14	-6	3.71	G1391	SN..1911



G127



SN..1911

C1907	CNX 19X340	PU 05	US 38	8,0	M10x1	29	NT 06	MT 06	HXK 4
C1911	CNX 19X340	PU 16	US 95	10,0	M10x1	30,5	NT 06	MT 06	HXK 4

* Special items



S-DKT(RL)5556



Basic R/L handed tool shank for KTP cartridge heads.

Suited for renovation of railway wheels. Available in shank size 56x55 mm. Body treated for longer tool life.

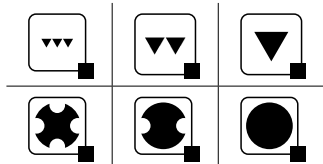
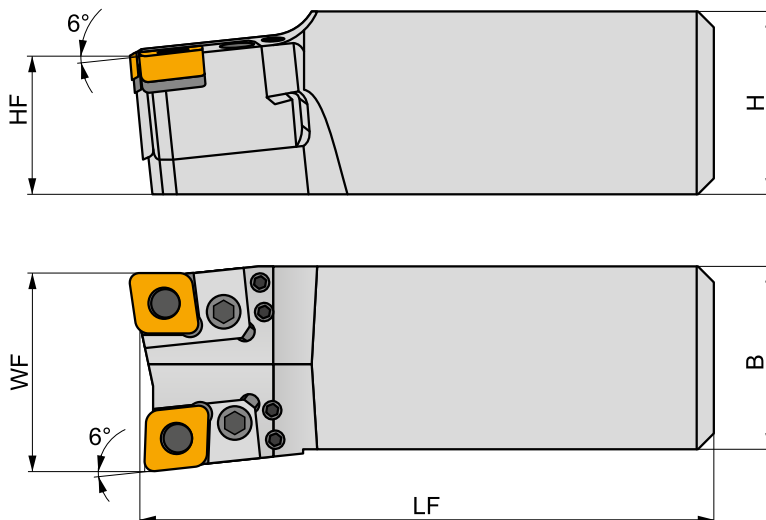
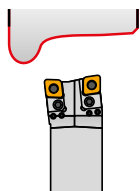

Product	H	B	LF	HF	WF	LAMS	GAMO	kg		
	(mm)	(mm)	(mm)	(mm)	(mm)	(°)	(°)			
R S-DKTR5556-000381*	56	55	176	42.3	55.5	-6	-6	3.40	GI391	DKT
L S-DKTL5556-000382*	56	55	176	42.3	55.5	-6	-6	3.40	GI390	DKT

GI390	KTP-LANL 19	KTP-LANL 30	KTP-SANL 19	KTP-CANL 19xx	KTP-LFNR 19	KTP-SFNR 19	KTP-CFNR 19
GI391	KTP-LANR 19	KTP-LANR 30	KTP-SANR 19	KTP-CANR 19xx	KTP-LFNL 19	KTP-SFNL 19	KTP-CFNL 19

DKT	USS 0617					HXK 3	

* Special items



KTP-SAN(RL)



Cartridge for SNMX 19 inserts for railway wheel returning

Lever lock type R/L handed turning cartridge for negative SNMX 19 insert. For mounting on DKT tool holder. Suited for renovation of railway wheels. Tool holder treated for longer tool life.

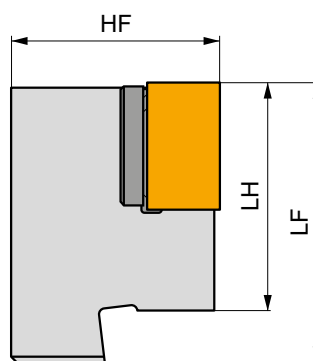
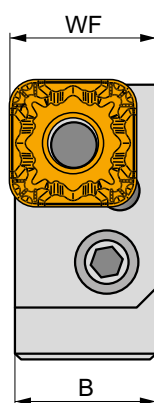
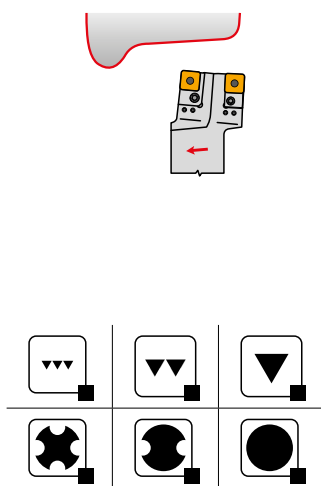

Product	⌀	B	WF	LF	HF	kg		
	(mm)	(mm)	(mm)	(mm)	(mm)			
R KTP-SANR 19	32	22	23	43	35	0.20	GI203	SN19
L KTP-SANL 19	32	22	23	43	35	0.20	GI203	SN19

GI203	SNMX 1911..

SN19	SNX 19X340	PU 16	US 95	10.0	M 10x1	30.5	NT 06	MT 06	HXK 4



KTP-SFN(RL)



PRAMET

P



Cartridge for SNMX 19 inserts for railway wheel returning

Lever lock type R/L handed turning cartridge for negative SNMX 19 insert. For mounting on DKT tool holder. Suited for renovation of railway wheels. Tool holder treated for longer tool life.

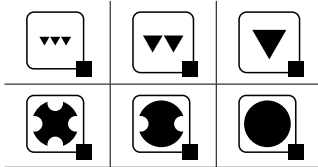
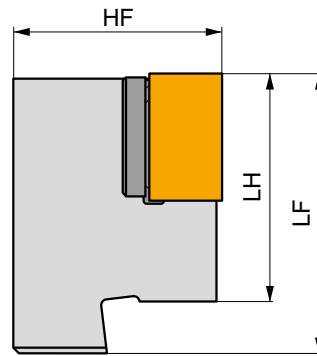
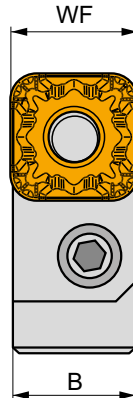
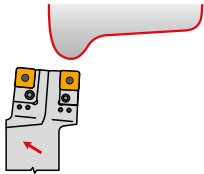

Product	HF (mm)	B (mm)	WF (mm)	LF (mm)	LH (mm)	kg		
R KTP-SFNR 19	32	18.25	19	43	35	0.16	GI203	SN19
L KTP-SFNL 19	32	18.25	19	43	35	0.16	GI203	SN19



GI203



SNMX 1911..



SN19



SNX 19X340



PU 16



US 95



10.0



M 10x1



30.5



NT 06



MT 06



HXK 4

**TN**

16/ 22/ 27/ 33

CARBIDE INSERTS**TNMN**

221

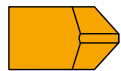
TU 14

221



TNMN



	IC (mm)	L (mm)	S (mm)
33	19.05	33.00	10.00
39	22.70	39.30	10.00

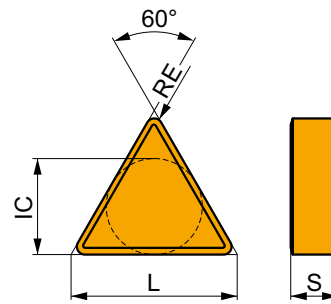

Suitability and starting values for cutting speed (vc), feed (f) and depth of cut (ap). Refer to our Machining Calculator app for further calculations.

Product	RE (mm)	P			M			K			N			S			H		
		vc (m/min)	f (mm/rev)	ap (mm)	vc (m/min)	f (mm/rev)	ap (mm)	vc (m/min)	f (mm/rev)	ap (mm)	vc (m/min)	f (mm/rev)	ap (mm)	vc (m/min)	f (mm/rev)	ap (mm)	vc (m/min)	f (mm/rev)	ap (mm)

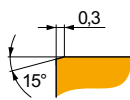

Geometry for roughing to heavy-rough machining, and continuous to interrupted cuts.

TNMN 33-013001*

S30	4.0	40	0.85	4.0	-	-	-	-	-	-	-	-	-	-	-	-	-	-	-
------------	-----	----	------	-----	---	---	---	---	---	---	---	---	---	---	---	---	---	---	---

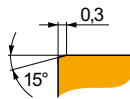

Geometry for roughing to heavy-rough machining, and continuous to interrupted cuts.

TNMN 39-018102*

S30	6.0	40	0.85	4.0	-	-	-	-	-	-	-	-	-	-	-	-	-	-	-
------------	-----	----	------	-----	---	---	---	---	---	---	---	---	---	---	---	---	---	---	---

* Special items

TU 14



	W1 (mm)	L (mm)	S (mm)
14	14.10	24.70	7.50

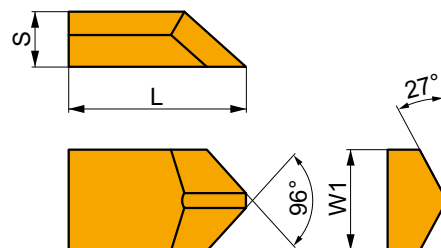

Suitability and starting values for cutting speed (vc), feed (f) and depth of cut (ap). Refer to our Machining Calculator app for further calculations.

Product	RE (mm)	P			M			K			N			S			H		
		vc (m/min)	f (mm/rev)	ap (mm)	vc (m/min)	f (mm/rev)	ap (mm)	vc (m/min)	f (mm/rev)	ap (mm)	vc (m/min)	f (mm/rev)	ap (mm)	vc (m/min)	f (mm/rev)	ap (mm)	vc (m/min)	f (mm/rev)	ap (mm)



External chip breaker - used with TNMN inserts.

TU 14-2500612*

GJ6	-	-	-	-	-	-	-	-	-	-	-	-	-	-	-	-	-	-	-
GJ11	-	-	-	-	-	-	-	-	-	-	-	-	-	-	-	-	-	-	-

* Special items



VN

16

CARBIDE INSERTS

VNMG



223

MATCH THE RIGHT SIZE (example)

Insert

VNMG 160404E-SF

Tool Holder

DVJNL 2020 K 16

DVJN(RL) EXT

93°

VN..



16

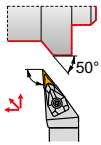

20×20
32×25

226

223

DVPN(RL) EXT

62°30'

VN..



16

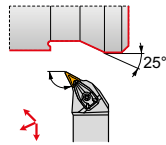

20×20
32×25

227

223

MVJN(RL) EXT

93°

VN..



16

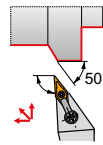

20×20
32×25

228

223

C.-DVJN(RL) EXT

93°

VN..



16

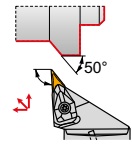

C4
C6

229

223



VNMG



	IC	D1	L	S
	(mm)	(mm)	(mm)	(mm)
1604	9.525	3.81	16.60	4.76

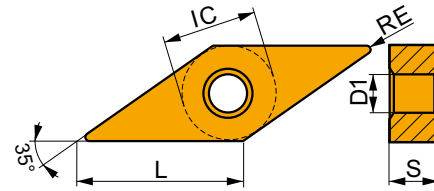

Suitability and starting values for cutting speed (vc), feed (f) and depth of cut (ap). Refer to our Machining Calculator app for further calculations.

Product	RE (mm)	P			M			K			N			S			H		
		vc (m/min)	f (mm/rev)	ap (mm)	vc (m/min)	f (mm/rev)	ap (mm)	vc (m/min)	f (mm/rev)	ap (mm)	vc (m/min)	f (mm/rev)	ap (mm)	vc (m/min)	f (mm/rev)	ap (mm)	vc (m/min)	f (mm/rev)	ap (mm)

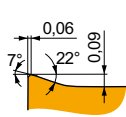

FF geometry with highly positive design for fine-finish machining and continuous to slightly interrupted cuts.

VNMG 160404E-FF	T7325	0.4	✓	165	0.12	1.0	■	125	0.11	1.0	■	-	-	-	-	-	-	-	-
	T8315	0.4	✓	150	0.12	1.0	■	90	0.11	1.0	✓	140	0.12	1.0	-	-	-	-	-
	T8430	0.4	■	175	0.12	1.0	■	95	0.11	1.0	✓	140	0.12	1.0	-	-	-	-	-

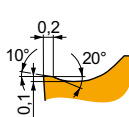

FM geometry with positive design for finish to semi-rough machining and continuous to slightly interrupted cuts.

VNMG 160404E-FM	T7325	0.4	✓	140	0.20	1.2	✓	105	0.18	1.2	■	-	-	-	✓	45	0.20	1.0	-	-	-
	T8430	0.4	■	135	0.20	1.2	✓	75	0.18	1.2	✓	110	0.20	1.2	■	25	0.14	1.0	-	-	-
	T9310	0.4	■	210	0.20	1.2	-	-	-	-	✓	195	0.20	1.2	-	-	-	-	-	-	-
	T9315	0.4	■	190	0.20	1.2	-	-	-	-	✓	180	0.20	1.2	-	-	-	-	-	-	-
VNMG 160408E-FM	T9325	0.4	■	170	0.20	1.2	✓	100	0.18	1.2	✓	160	0.20	1.2	-	-	-	✓	35	0.20	1.0
	T7325	0.8	✓	160	0.20	1.4	✓	120	0.18	1.4	■	-	-	-	✓	50	0.16	1.1	-	-	-
	T8430	0.8	■	165	0.20	1.4	✓	90	0.18	1.4	✓	135	0.20	1.4	-	-	-	✓	35	0.16	1.1
	T9310	0.8	■	245	0.20	1.4	-	-	-	-	✓	230	0.20	1.4	-	-	-	-	-	-	-
	T9315	0.8	■	220	0.20	1.4	-	-	-	-	✓	205	0.20	1.4	-	-	-	-	-	-	-
VNMG 160412E-FM	T9325	0.8	■	200	0.20	1.4	✓	120	0.18	1.4	✓	190	0.20	1.4	-	-	-	✓	45	0.16	1.1
	T8430	1.2	■	165	0.22	1.4	✓	90	0.20	1.4	✓	135	0.22	1.4	-	-	-	✓	35	0.18	1.1
	T9315	1.2	■	225	0.22	1.4	-	-	-	-	✓	210	0.22	1.4	-	-	-	-	-	-	-
T9325	1.2	■	200	0.22	1.4	✓	120	0.20	1.4	✓	190	0.22	1.4	-	-	-	✓	45	0.18	1.1	

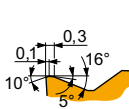

M geometry for finish to semi-rough machining and continuous to interrupted cuts.

VNMG 160404E-M	T5315	0.4	✓	180	0.20	1.2	-	-	-	■	170	0.20	1.2	-	-	-	-	-	✓	35	0.14	0.3
	T9315	0.4	■	170	0.20	1.2	-	-	-	✓	160	0.20	1.2	-	-	-	-	-	✓	30	0.14	0.3
	T9325	0.4	■	155	0.20	1.2	-	-	-	-	✓	145	0.20	1.2	-	-	-	-	-	-	-	
VNMG 160408E-M	T5305	0.8	✓	205	0.30	1.4	-	-	-	■	190	0.30	1.4	-	-	-	-	-	✓	40	0.15	0.7
	T5315	0.8	✓	185	0.30	1.4	-	-	-	■	175	0.30	1.4	-	-	-	-	-	✓	35	0.15	0.7
	T9310	0.8	■	185	0.30	1.4	-	-	-	✓	175	0.30	1.4	-	-	-	-	-	✓	35	0.15	0.7
	T9315	0.8	■	170	0.30	1.4	-	-	-	✓	160	0.30	1.4	-	-	-	-	-	✓	30	0.15	0.7
	T9325	0.8	■	150	0.30	1.4	-	-	-	✓	140	0.30	1.4	-	-	-	-	-	-	-	-	
	T9335	0.8	■	130	0.30	1.4	-	-	-	-	-	-	-	-	-	-	-	-	-	-	-	
VNMG 160412E-M	T9325	1.2	■	140	0.40	1.4	-	-	-	✓	130	0.40	1.4	-	-	-	-	-	-	-	-	



Suitability and starting values for cutting speed (vc), feed (f) and depth of cut (ap). Refer to our Machining Calculator app for further calculations.

Product	RE (mm)	P			M			K			N			S			H		
		vc (m/min)	f (mm/rev)	ap (mm)	vc (m/min)	f (mm/rev)	ap (mm)	vc (m/min)	f (mm/rev)	ap (mm)	vc (m/min)	f (mm/rev)	ap (mm)	vc (m/min)	f (mm/rev)	ap (mm)	vc (m/min)	f (mm/rev)	ap (mm)

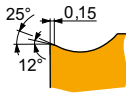

NF geometry with highly positive design for fine-finish to medium machining, and continuous cuts.

VNMG 160404E-NF	T6310	0.4	█	140	0.12	1.2	█	100	0.11	1.2	█	110	0.12	1.2	█	420	0.14	1.2	█	40	0.11	1.0	-	-	-
	T7325	0.4	█	140	0.18	1.2	█	105	0.16	1.2	-	-	-	-	-	█	45	0.16	1.0	-	-	-	-	-	-
	T7335	0.4	█	140	0.18	1.2	█	105	0.16	1.2	-	-	-	-	-	█	45	0.16	1.0	-	-	-	-	-	-
	T8315	0.4	█	150	0.12	1.2	█	90	0.11	1.2	█	140	0.12	1.2	█	450	0.14	1.2	█	35	0.11	1.0	-	-	-
	T8430	0.4	█	175	0.12	1.2	█	95	0.11	1.2	█	140	0.12	1.2	█	480	0.14	1.2	█	35	0.11	1.0	-	-	-
	T9315	0.4	█	235	0.12	1.2	-	-	-	-	█	220	0.12	1.2	-	-	-	-	-	-	-	-	-	-	-
VNMG 160408E-NF	T6310	0.8	█	145	0.17	1.4	█	100	0.15	1.4	█	115	0.17	1.4	█	435	0.20	1.4	█	40	0.14	1.1	-	-	-
	T7325	0.8	█	165	0.18	1.4	█	125	0.16	1.4	-	-	-	-	-	█	50	0.16	1.1	-	-	-	-	-	
	T7335	0.8	█	160	0.18	1.4	█	120	0.16	1.4	-	-	-	-	-	█	50	0.16	1.1	-	-	-	-	-	
	T8315	0.8	█	160	0.17	1.4	█	95	0.15	1.4	█	150	0.17	1.4	█	480	0.20	1.4	█	40	0.14	1.1	-	-	-
	T8430	0.8	█	175	0.17	1.4	█	95	0.15	1.4	█	140	0.17	1.4	█	480	0.20	1.4	█	35	0.14	1.1	-	-	-
	T9315	0.8	█	240	0.17	1.4	-	-	-	-	█	225	0.17	1.4	-	-	-	-	-	-	-	-	-	-	-
T9325	0.8	█	210	0.18	1.4	█	125	0.16	1.4	█	195	0.18	1.4	-	-	-	█	45	0.16	1.1	-	-	-	-	

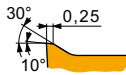

NM geometry with highly positive design for fine-finish, medium and rough machining, with continuous cuts.

VNMG 160404E-NM	T7325	0.4	█	145	0.20	1.2	█	110	0.18	1.2	-	-	-	-	-	█	45	0.20	1.0	-	-	-	-	-
	T7335	0.4	█	140	0.20	1.2	█	105	0.18	1.2	-	-	-	-	-	█	45	0.20	1.0	-	-	-	-	-
	T8315	0.4	█	135	0.20	1.2	█	80	0.18	1.2	-	-	-	█	405	0.24	1.2	█	30	0.20	1.0	-	-	-
	T8430	0.4	█	145	0.20	1.2	█	80	0.18	1.2	-	-	-	█	405	0.24	1.2	█	30	0.20	1.0	-	-	-
	T9325	0.4	█	180	0.20	1.2	█	105	0.18	1.2	-	-	-	-	-	█	40	0.20	1.0	-	-	-	-	-
VNMG 160408E-NM	T7325	0.8	█	160	0.25	1.4	█	120	0.23	1.4	-	-	-	-	-	█	50	0.20	1.1	-	-	-	-	-
	T7335	0.8	█	155	0.25	1.4	█	120	0.23	1.4	-	-	-	-	-	█	50	0.20	1.1	-	-	-	-	-
	T8315	0.8	█	145	0.25	1.4	█	85	0.23	1.4	-	-	-	█	435	0.30	1.4	█	35	0.20	1.1	-	-	-
	T8430	0.8	█	155	0.25	1.4	█	85	0.23	1.4	-	-	-	█	435	0.30	1.4	█	30	0.20	1.1	-	-	-
	T9325	0.8	█	190	0.25	1.4	█	110	0.23	1.4	-	-	-	-	-	█	40	0.20	1.1	-	-	-	-	-

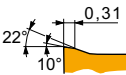

NMR geometry with positive design for medium to rough machining, and continuous cuts.

VNMG 160404E-NMR	T7325	0.4	█	125	0.20	1.2	█	95	0.18	1.2	-	-	-	-	-	█	40	0.18	1.0	-	-	-	-
	T9325	0.4	█	155	0.20	1.2	█	90	0.18	1.2	-	-	-	-	-	█	30	0.18	1.0	-	-	-	-
VNMG 160408E-NMR	T7325	0.8	█	130	0.30	1.4	█	100	0.27	1.4	-	-	-	-	-	█	40	0.24	1.1	-	-	-	-
	T8430	0.8	█	125	0.30	1.4	█	65	0.27	1.4	-	-	-	-	-	█	25	0.24	1.1	-	-	-	-
	T9315	0.8	█	170	0.30	1.4	-	-	-	-	-	-	-	-	-	-	-	-	-	-	-	-	-
	T9325	0.8	█	150	0.30	1.4	█	90	0.27	1.4	-	-	-	-	-	█	30	0.24	1.1	-	-	-	-
VNMG 160412E-NMR	T8430	1.2	█	130	0.30	1.4	█	70	0.27	1.4	-	-	-	-	-	█	25	0.24	1.1	-	-	-	-

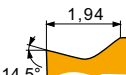

SF geometry with positive design for fine-finish machining and for machining thin walls, with continuous cuts.

VNMG 160404E-SF	T6310	0.4	█	125	0.15	1.2	█	90	0.14	1.2	█	100	0.15	1.2	█	375	0.18	1.2	█	35	0.14	1.0	█	25	0.15	0.3
	T7325	0.4	█	145	0.15	1.2	█	110	0.14	1.2	-	-	-	-	-	█	45	0.14	1.0	-	-	-	-	-	-	
	T8315	0.4	█	135	0.15	1.2	█	80	0.14	1.2	█	125	0.15	1.2	█	405	0.18	1.2	█	30	0.14	1.0	█	25	0.15	0.3
	T8430	0.4	█	145	0.15	1.2	█	80	0.14	1.2	█	120	0.15	1.2	█	405	0.18	1.2	█	30	0.14	1.0	█	25	0.15	0.3
VNMG 160408E-SF	T6310	0.8	█	140	0.17	1.4	█	100	0.15	1.4	█	110	0.17	1.4	█	420	0.20	1.4	█	40	0.14	1.1	█	25	0.11	0.7
	T8315	0.8	█	150	0.17	1.4	█	90	0.15	1.4	█	140	0.17	1.4	█	450	0.20	1.4	█	35	0.14	1.1	█	30	0.11	0.7
	T8430	0.8	█	165	0.17	1.4	█	90	0.15	1.4	█	135	0.17	1.4	█	450	0.20	1.4	█	35	0.14	1.1	█	25	0.11	0.7
	T9315	0.8	█	230	0.17	1.4	-	-	-	-	█	215	0.17	1.4	-	-	-	-	-	█	45	0.12	0.7	-	-	-
	T9325	0.8	█	205	0.17	1.4	█	120	0.15	1.4	█	190	0.17	1.4	-	-	-	█	45	0.15	1.1	-	-	-	-	



Suitability and starting values for cutting speed (vc), feed (f) and depth of cut (ap). Refer to our Machining Calculator app for further calculations.

Product	RE (mm)	P			M			K			N			S			H		
		vc (m/min)	f (mm/rev)	ap (mm)	vc (m/min)	f (mm/rev)	ap (mm)	vc (m/min)	f (mm/rev)	ap (mm)	vc (m/min)	f (mm/rev)	ap (mm)	vc (m/min)	f (mm/rev)	ap (mm)	vc (m/min)	f (mm/rev)	ap (mm)

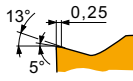

SM geometry with positive design for medium machining, and continuous to interrupted cuts.

VNMG 160404E-SM	T6310	0.4	■	120	0.18	1.2	■	85	0.16	1.2	■	95	0.18	1.2	☑	360	0.22	1.2	■	35	0.16	1.0	☑	20	0.13	0.3
	T7325	0.4	☑	135	0.18	1.2	■	105	0.16	1.2	■	-	-	-	■	-	-	-	■	40	0.16	1.0	■	-	-	-
	T8430	0.4	■	135	0.18	1.2	■	75	0.16	1.2	☑	110	0.18	1.2	☑	375	0.22	1.2	☑	25	0.16	1.0	☑	20	0.13	0.3
	T9315	0.4	■	190	0.18	1.2	■	-	-	-	☑	180	0.18	1.2	■	-	-	-	■	-	-	-	☑	35	0.13	0.3
	T9325	0.4	■	170	0.18	1.2	■	100	0.16	1.2	☑	160	0.18	1.2	■	-	-	-	☑	35	0.16	1.0	■	-	-	-
VNMG 160408E-SM	T6310	0.8	■	125	0.25	1.4	■	90	0.23	1.4	■	100	0.25	1.4	☑	375	0.30	1.4	■	35	0.20	1.1	☑	25	0.13	0.7
	T7325	0.8	☑	145	0.25	1.4	■	110	0.23	1.4	■	-	-	-	■	-	-	-	■	45	0.20	1.1	■	-	-	-
	T8430	0.8	■	140	0.25	1.4	■	75	0.23	1.4	☑	115	0.25	1.4	☑	390	0.30	1.4	☑	30	0.20	1.1	☑	20	0.13	0.7
	T9325	0.8	■	170	0.25	1.4	■	100	0.23	1.4	☑	160	0.25	1.4	■	-	-	-	☑	35	0.20	1.1	■	-	-	-



DVJN(RL) EXT



External Double Clamp Holder with 93° Cutting Angle for VN.. Insert

External Right/Left hand double clamp tool holder with 93° cutting angle. Suited for longitudinal turning with shoulder, copy and taper turning and chamfering with negative VN.. 16 size inserts. Available in 20x20 up to 32x32 mm shank. Body treated for longer tool life.

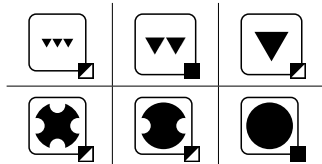
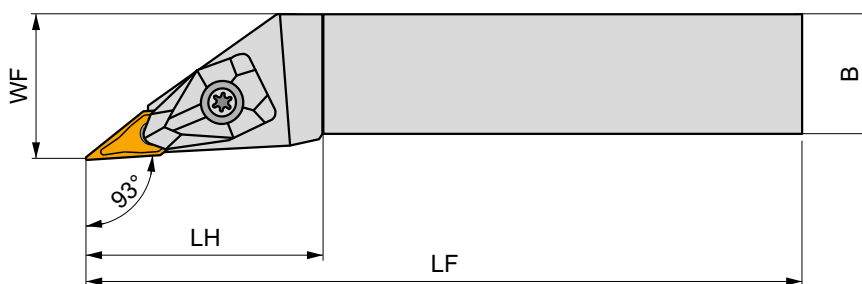
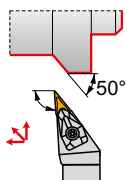

Product	H	B	HF	WF	LF	LH	LAMS	GAMO	kg		
	(mm)	(mm)	(mm)	(mm)	(mm)	(mm)	(°)	(°)			
R DVJNR 2020 K 16	20	20	20	25	125	46.4	-13	-4	0.43	G1048	DV16
DVJNR 2525 M 16	25	25	25	32	150	46.4	-13	-4	0.74	G1048	DV16
DVJNR 3225 P 16	32	25	32	32	170	46.4	-13	-4	1.05	G1048	DV16
L DVJNL 2020 K 16	20	20	20	25	125	46.4	-13	-4	0.43	G1048	DV16
DVJNL 2525 M 16	25	25	25	32	150	46.4	-13	-4	0.75	G1048	DV16
DVJNL 3225 P 16	32	25	32	32	170	46.4	-13	-4	1.06	G1048	DV16



G1048



VN.. 1604..



DV16



DCS 16V



3.0



DVS 269-01



US 2009-T15P



FLAGT15P/3,5



DVPN(RL) EXT

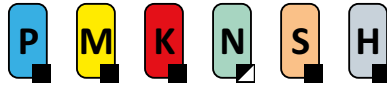

External Double Clamp Holder with 117.5° Cutting Angle for VN.. Insert

External Right/Left hand double clamp tool holder with 117.5° Cutting Angle. Suited for longitudinal and face turning with shoulder, copy and taper turning and chamfering with negative VN.. 16 size inserts. Available in 25x25 and 32x25 mm shank. Body treated for longer tool life.

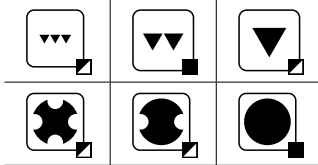
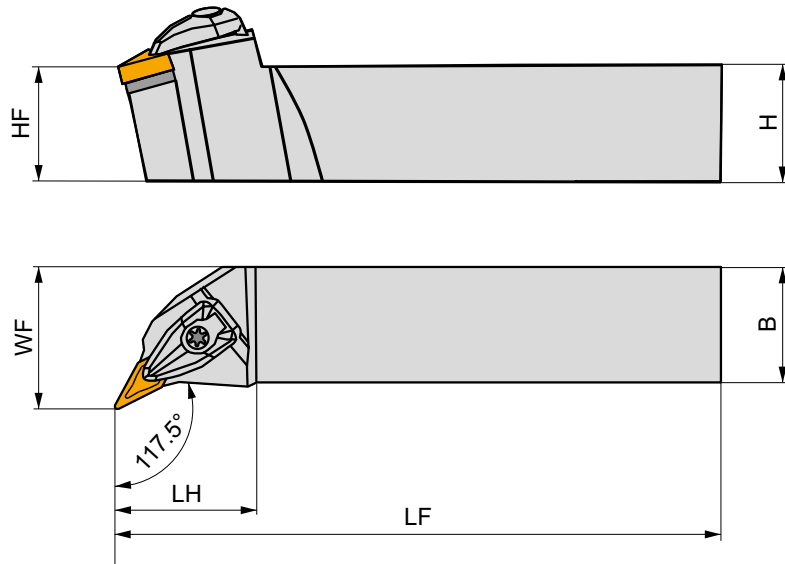
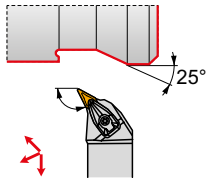

Product	H (mm)	B (mm)	HF (mm)	WF (mm)	LF (mm)	LH (mm)	LAMS (°)	GAMO (°)	kg	GI048	DV16
R DVPNR 2525 M 16	25	25	25	32	150	39.2	-13	-4	0.75	GI048	DV16
DVPNR 3225 P 16	32	25	32	32	170	39.2	-13	-4	1.06	GI048	DV16
L DVPNL 2525 M 16	25	25	25	32	150	39.2	-13	-4	0.74	GI048	DV16
DVPNL 3225 P 16	32	25	32	32	170	39.2	-13	-4	1.06	GI048	DV16



GI048



VN.. 1604..



DV16



DCS 16V



3.0



DVS 269-01



US 2009-T15P



FLAG T15P/3,5



MVJN(RL) EXT



External Multi-Clamp Holder with 93° Cutting Angle for VN.. Insert

External Right/Left hand multi-clamp turning holder with 93° cutting angle. Suited for longitudinal turning with shoulder, copy turning up to 50°, taper and chamfer turning with negative VN.. 16 insert. Available with shank size 20x20 up to 32x25 mm. Body treated for longer tool life.

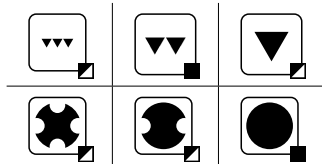
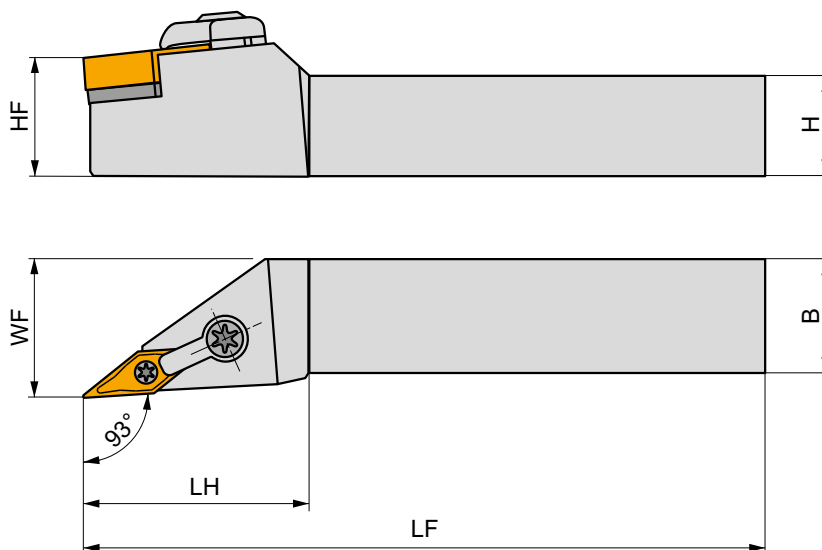
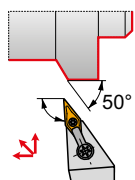

Product	H	B	HF	WF	LF	LH	LAMS	GAMO	kg		
	(mm)	(mm)	(mm)	(mm)	(mm)	(mm)	(°)	(°)			
R MVJNR 2020 K 16-A	20	20	20	25	125	41	-4.5	-13.5	0.40	G1048	MV2
MVJNR 2525 M 16-A	25	25	25	32	150	41	-4.5	-13.5	0.70	G1048	MV2
MVJNR 3225 P 16-A	32	25	32	32	170	41	-4.5	-13.5	0.98	G1048	MV2
L MVJNL 2020 K 16-A	20	20	20	25	125	41	-4.5	-13.5	0.40	G1048	MV2
MVJNL 2525 M 16-A	25	25	25	32	150	41	-4.5	-13.5	0.70	G1048	MV2
MVJNL 3225 P 16-A	32	25	32	32	170	41	-4.5	-13.5	0.96	G1048	MV2



G1048



VN.. 1604..



MV2



UPC22



MVN 160316



UP 0909-T09P



2.0



PS 6026-T09P



2.0



FLAG T09P



C.-DVJN(RL) EXT

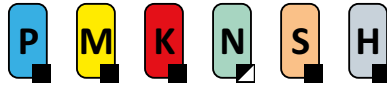

External PSC Quick Change Tool, Double Clamp, 93° Cutting Angle, VN.. Insert

External Right/Left hand double clamp tool, through coolant, with 93° cutting angle for longitudinal turning with shoulder, copy and taper turning and chamfering with negative VN.. 16 size inserts. Available with PSC (Polygon Shank Coupling) C4 up to C6 shank. Body treated for longer tool life.

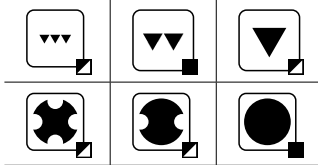
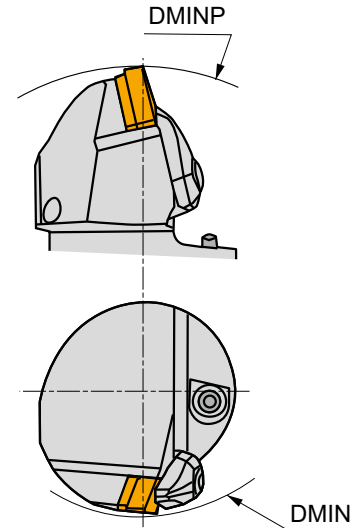
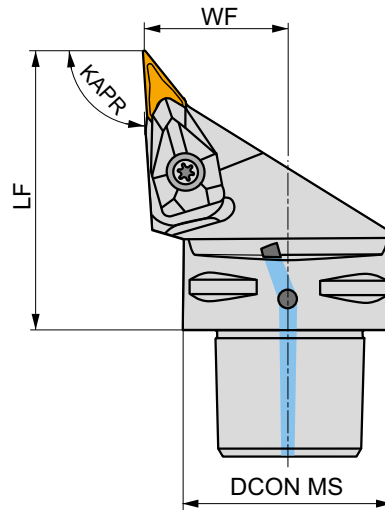
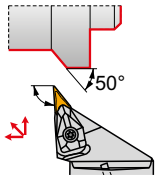

Product	DCON MS	DMIN	DMINP	WF	LF	KAPR	LAMS	GAMO				
	(mm)	(mm)	(mm)	(mm)	(mm)	(°)	(°)	(°)				
R C4-DVJNR-27062-16	40	60	152	27	62	93	-13	-4	✓	0.45	G1048	C-DV16-1
C5-DVJNR-35065-16	50	65	170	35	65	93	-13	-4	✓	0.47	G1048	C-DV16-2
C6-DVJNR-45065-16	63	81	190	45	65	93	-13	-4	✓	1.13	G1048	C-DV16-2
L C4-DVJNL-27062-16	40	60	152	27	62	93	-13	-4	✓	0.45	G1048	C-DV16-1
C5-DVJNL-35065-16	50	65	170	35	65	93	-13	-4	✓	0.71	G1048	C-DV16-2
C6-DVJNL-45065-16	63	81	190	45	65	93	-13	-4	✓	1.13	G1048	C-DV16-2



G1048



VN.. 1604..



C-DV16-1



DCS 16V



Nm

3.0



DVS 269-01



US 2009-T15P



FLAGT15P/3,5



CN 034-01

C-DV16-2

DCS 16V

3.0

DVS 269-01

US 2009-T15P

FLAGT15P/3,5

CN 034-02



WN

06/ 08/ 10/ 13

CARBIDE INSERTS

WNMG



231

WNMM



238

MATCH THE RIGHT SIZE (example)

Insert

WNMA 080408

Tool Holder

DWLNL 2020 K 08

DWLN(RL) EXT

95°

WN..

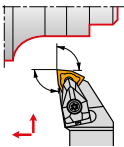
 $\frac{16 \times 16}{40 \times 40}$

239

231 – 238

MWLN(RL) EXT

95°

WN..

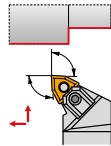
 $\frac{25 \times 25}{40 \times 40}$

241

231 – 238

PWLN(RL) EXT

95°

WN..

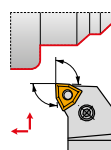
 $\frac{16 \times 16}{32 \times 25}$

242

231 – 238

C.-DWLN(RL) EXT

95°

WN..

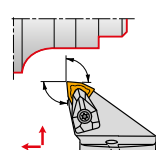
 $\frac{C4}{C6}$

243

231 – 238



WNMG



	IC	D1	L	S
	(mm)	(mm)	(mm)	(mm)
0604	9.525	3.81	6.50	4.76
06T3	9.525	3.81	6.50	3.97
0804	12.700	5.16	8.70	4.76

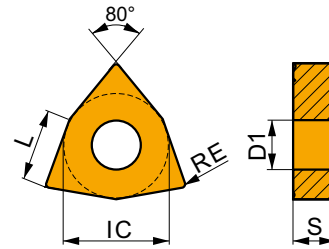

Suitability and starting values for cutting speed (vc), feed (f) and depth of cut (ap). Refer to our Machining Calculator app for further calculations.

Product	RE (mm)	P			M			K			N			S			H		
		vc (m/min)	f (mm/rev)	ap (mm)	vc (m/min)	f (mm/rev)	ap (mm)	vc (m/min)	f (mm/rev)	ap (mm)	vc (m/min)	f (mm/rev)	ap (mm)	vc (m/min)	f (mm/rev)	ap (mm)	vc (m/min)	f (mm/rev)	ap (mm)

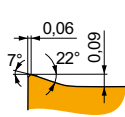

FF geometry with highly positive design for fine-finish machining, and continuous to slightly interrupted cuts.

WNMG 060402E-FF	T8315	0.2	215	0.10	1.0	125	0.09	1.0	200	0.10	1.0	-	-	-	-	-	-	-
WNMG 060404E-FF	T8315	0.4	220	0.12	1.0	130	0.11	1.0	205	0.12	1.0	-	-	-	-	-	-	-
WNMG 080404E-FF	T7325	0.4	235	0.12	1.0	180	0.11	1.0	-	-	-	-	-	-	-	-	-	-
	T8315	0.4	220	0.12	1.0	130	0.11	1.0	205	0.12	1.0	-	-	-	-	-	-	-
WNMG 080408E-FF	T8315	0.8	245	0.15	1.0	145	0.14	1.0	230	0.15	1.0	-	-	-	-	-	-	-

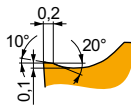

FM geometry with positive design for finish to semi-rough machining, and continuous to slightly interrupted cuts.

WNMG 060404E-FM	T7325	0.4	195	0.20	1.4	150	0.18	1.4	-	-	-	60	0.16	1.1	-	-	-
	T8315	0.4	180	0.20	1.4	105	0.18	1.4	170	0.20	1.4	45	0.14	1.1	-	-	-
	T8430	0.4	195	0.20	1.4	105	0.18	1.4	160	0.20	1.4	40	0.14	1.1	-	-	-
	T9315	0.4	265	0.20	1.4	-	-	-	250	0.20	1.4	-	-	-	-	-	-
	T9325	0.4	240	0.20	1.4	140	0.18	1.4	225	0.20	1.4	50	0.16	1.1	-	-	-
	TT310	0.4	275	0.20	1.4	165	0.18	1.4	-	-	-	-	-	-	-	-	-
WNMG 060408E-FM	T7325	0.8	235	0.20	1.4	180	0.18	1.4	-	-	-	75	0.16	1.1	-	-	-
	T8430	0.8	235	0.20	1.4	125	0.18	1.4	190	0.20	1.4	50	0.14	1.1	-	-	-
	T9315	0.8	315	0.20	1.4	-	-	-	295	0.20	1.4	-	-	-	-	-	-
	T9325	0.8	285	0.20	1.4	170	0.18	1.4	270	0.20	1.4	60	0.16	1.1	-	-	-
WNMG 060412E-FM	T9315	1.2	300	0.27	1.2	-	-	-	285	0.27	1.2	-	-	-	-	-	-
WNMG 06T304E-FM	T8430	0.4	195	0.20	1.4	105	0.18	1.4	160	0.20	1.4	40	0.14	1.1	-	-	-
	T9325	0.4	240	0.20	1.4	140	0.18	1.4	225	0.20	1.4	50	0.16	1.1	-	-	-
WNMG 06T308E-FM	T8430	0.8	235	0.20	1.4	125	0.18	1.4	190	0.20	1.4	50	0.14	1.1	-	-	-
	T9325	0.8	285	0.20	1.4	170	0.18	1.4	270	0.20	1.4	60	0.16	1.1	-	-	-
WNMG 080404E-FM	T7325	0.4	190	0.20	1.9	145	0.18	1.9	-	-	-	60	0.16	1.5	-	-	-
	T7335	0.4	180	0.20	1.9	140	0.18	1.9	-	-	-	55	0.16	1.5	-	-	-
	T8315	0.4	180	0.20	1.9	105	0.18	1.9	170	0.20	1.9	45	0.14	1.5	-	-	-
	T8430	0.4	190	0.20	1.9	105	0.18	1.9	155	0.20	1.9	40	0.14	1.5	-	-	-
	T9310	0.4	285	0.20	1.9	-	-	-	270	0.20	1.9	-	-	-	-	-	-
	T9315	0.4	270	0.20	1.2	-	-	-	255	0.20	1.2	-	-	-	-	-	-
WNMG 080408E-FM	T9325	0.4	245	0.20	1.2	145	0.18	1.2	230	0.20	1.2	55	0.16	1.0	-	-	-
	T7325	0.8	225	0.20	1.9	175	0.18	1.9	-	-	-	70	0.16	1.5	-	-	-
	T7335	0.8	215	0.20	1.9	165	0.18	1.9	-	-	-	65	0.16	1.5	-	-	-
	T8315	0.8	210	0.20	1.9	125	0.18	1.9	195	0.20	1.9	50	0.16	1.5	-	-	-
	T8430	0.8	225	0.20	1.9	120	0.18	1.9	185	0.20	1.9	45	0.16	1.5	-	-	-
	T9310	0.8	335	0.20	1.9	-	-	-	315	0.20	1.9	-	-	-	-	-	-
	T9315	0.8	310	0.20	1.9	-	-	-	290	0.20	1.9	-	-	-	-	-	-
	T9325	0.8	280	0.20	1.9	165	0.18	1.9	265	0.20	1.9	60	0.16	1.5	-	-	-



Suitability and starting values for cutting speed (vc), feed (f) and depth of cut (ap). Refer to our Machining Calculator app for further calculations.

Product	RE (mm)	P			M			K			N			S			H		
		vc	f	ap	vc	f	ap	vc	f	ap	vc	f	ap	vc	f	ap	vc	f	ap
		(m/min)	(mm/rev)	(mm)	(m/min)	(mm/rev)	(mm)	(m/min)	(mm/rev)	(mm)	(m/min)	(mm/rev)	(mm)	(m/min)	(mm/rev)	(mm)	(m/min)	(mm/rev)	(mm)

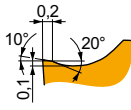

FM geometry with positive design for finish to semi-rough machining, and continuous to slightly interrupted cuts.

WNMG 080412E-FM	T7325	1.2	220	0.27	1.9	170	0.24	1.9	-	-	-	-	-	-	70	0.19	1.5	-	-	-	
	T7335	1.2	205	0.27	1.9	155	0.24	1.9	-	-	-	-	-	-	65	0.19	1.5	-	-	-	
	T8430	1.2	210	0.27	1.9	115	0.24	1.9	175	0.27	1.9	-	-	-	45	0.19	1.5	-	-	-	
	T9310	1.2	310	0.27	1.9	-	-	-	290	0.27	1.9	-	-	-	-	-	-	-	-	-	-
	T9315	1.2	285	0.27	1.9	-	-	-	270	0.27	1.9	-	-	-	-	-	-	-	-	-	-
	T9325	1.2	255	0.27	1.9	150	0.24	1.9	240	0.27	1.9	-	-	-	55	0.19	1.5	-	-	-	-

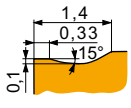

KR geometry for semi-rough to rough machining, and continuous to interrupted cuts.

WNMG 080408E-KR	T5305	0.8	255	0.35	3.5	-	-	-	240	0.35	3.5	-	-	-	-	-	-	50	0.18	0.7
	T5315	0.8	230	0.35	3.5	-	-	-	215	0.35	3.5	-	-	-	-	-	-	45	0.18	0.7
WNMG 080412E-KR	T5315	1.2	235	0.40	3.5	-	-	-	220	0.40	3.5	-	-	-	-	-	-	45	0.20	1.0

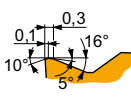

M geometry for finish to semi-rough machining, and continuous to interrupted cuts.

WNMG 060404E-M	T5315	0.4	250	0.20	1.8	-	-	-	235	0.20	1.8	-	-	-	-	-	-	50	0.13	0.3
	T9315	0.4	240	0.20	1.8	-	-	-	225	0.20	1.8	-	-	-	-	-	-	45	0.13	0.3
	T9325	0.4	215	0.20	1.8	-	-	-	200	0.20	1.8	-	-	-	-	-	-	-	-	-
WNMG 060408E-M	T5315	0.8	255	0.32	1.8	-	-	-	240	0.32	1.8	-	-	-	-	-	-	50	0.16	0.7
	T9310	0.8	250	0.32	1.8	-	-	-	235	0.32	1.8	-	-	-	-	-	-	50	0.16	0.7
	T9315	0.8	230	0.32	1.8	-	-	-	215	0.32	1.8	-	-	-	-	-	-	45	0.16	0.7
	T9325	0.8	205	0.32	1.8	-	-	-	190	0.32	1.8	-	-	-	-	-	-	-	-	-
	T9335	0.8	180	0.32	1.8	-	-	-	-	-	-	-	-	-	-	-	-	-	-	-
WNMG 080404E-M	T5315	0.4	260	0.20	1.2	-	-	-	245	0.20	1.2	-	-	-	-	-	-	50	0.13	0.3
	T9315	0.4	235	0.20	2.1	-	-	-	220	0.20	2.1	-	-	-	-	-	-	45	0.13	0.3
	T9325	0.4	210	0.20	2.1	-	-	-	195	0.20	2.1	-	-	-	-	-	-	-	-	-
	T9335	0.4	180	0.20	2.1	-	-	-	-	-	-	-	-	-	-	-	-	-	-	-
WNMG 080408E-M	T5305	0.8	280	0.32	2.1	-	-	-	265	0.32	2.1	-	-	-	-	-	-	55	0.16	0.7
	T5315	0.8	250	0.32	2.1	-	-	-	235	0.32	2.1	-	-	-	-	-	-	50	0.16	0.7
	T8430	0.8	170	0.32	2.1	-	-	-	135	0.32	2.1	-	-	-	-	-	-	25	0.16	0.7
	T9310	0.8	245	0.32	2.1	-	-	-	230	0.32	2.1	-	-	-	-	-	-	45	0.16	0.7
	T9315	0.8	225	0.32	2.1	-	-	-	210	0.32	2.1	-	-	-	-	-	-	45	0.16	0.7
	T9325	0.8	200	0.32	2.1	-	-	-	190	0.32	2.1	-	-	-	-	-	-	-	-	-
	T9335	0.8	180	0.32	2.1	-	-	-	-	-	-	-	-	-	-	-	-	-	-	-
WNMG 080412E-M	T5305	1.2	275	0.40	2.1	-	-	-	260	0.40	2.1	-	-	-	-	-	-	55	0.20	1.0
	T5315	1.2	245	0.40	2.1	-	-	-	230	0.40	2.1	-	-	-	-	-	-	45	0.20	1.0
	T9310	1.2	235	0.40	2.1	-	-	-	220	0.40	2.1	-	-	-	-	-	-	45	0.20	1.0
	T9315	1.2	220	0.40	2.1	-	-	-	205	0.40	2.1	-	-	-	-	-	-	40	0.20	1.0
	T9325	1.2	195	0.40	2.1	-	-	-	185	0.40	2.1	-	-	-	-	-	-	-	-	-

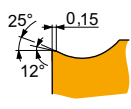

NF geometry with highly positive design for fine-finish to medium machining, and continuous cuts.

WNMG 060404E-NF	T6310	0.4	190	0.17	0.8	135	0.15	0.8	150	0.17	0.8	570	0.20	0.8	55	0.12	0.6	-	-	-
	T7325	0.4	215	0.18	0.8	165	0.16	0.8	-	-	-	-	-	-	65	0.16	0.6	-	-	-
	T7335	0.4	210	0.18	0.8	160	0.16	0.8	-	-	-	-	-	-	65	0.16	0.6	-	-	-
	T8315	0.4	200	0.17	0.8	120	0.15	0.8	190	0.17	0.8	600	0.20	0.8	50	0.12	0.6	-	-	-
	T8430	0.4	225	0.17	0.8	120	0.15	0.8	185	0.17	0.8	615	0.20	0.8	45	0.12	0.6	-	-	-
	T9315	0.4	305	0.17	0.8	-	-	-	285	0.17	0.8	-	-	-	-	-	-	-	-	-
	T9325	0.4	265	0.18	0.8	155	0.16	0.8	250	0.18	0.8	-	-	-	55	0.16	0.6	-	-	-
	T9335	0.4	265	0.18	0.8	155	0.16	0.8	250	0.18	0.8	-	-	-	55	0.16	0.6	-	-	-

BN

CN

DN

LN

SN

TN

VN

WN



Suitability and starting values for cutting speed (vc), feed (f) and depth of cut (ap). Refer to our Machining Calculator app for further calculations.

Product	RE (mm)	P			M			K			N			S			H		
		vc (m/min)	f (mm/rev)	ap (mm)	vc (m/min)	f (mm/rev)	ap (mm)	vc (m/min)	f (mm/rev)	ap (mm)	vc (m/min)	f (mm/rev)	ap (mm)	vc (m/min)	f (mm/rev)	ap (mm)	vc (m/min)	f (mm/rev)	ap (mm)

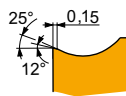

NF geometry with highly positive design for fine-finish to medium machining, and continuous cuts.

WNMG 060408E-NF	T6310	0.8	215	0.19	1.0	150	0.17	1.0	170	0.19	1.0	645	0.23	1.0	60	0.15	0.8	-	-	-
	T7325	0.8	245	0.19	1.0	190	0.17	1.0	-	-	-	-	-	-	75	0.15	0.8	-	-	-
	T8430	0.8	245	0.19	1.0	135	0.17	1.0	200	0.19	1.0	675	0.23	1.0	50	0.15	0.8	-	-	-
	T9315	0.8	335	0.19	1.0	-	-	-	315	0.19	1.0	-	-	-	-	-	-	-	-	-
	T9325	0.8	300	0.19	1.0	180	0.17	1.0	285	0.19	1.0	-	-	-	65	0.15	0.8	-	-	-
WNMG 080404E-NF	HF7	0.4	-	-	-	95	0.15	1.7	155	0.17	1.7	495	0.20	1.7	-	-	-	-	-	-
	T6310	0.4	180	0.17	1.7	125	0.15	1.7	145	0.17	1.7	540	0.20	1.7	50	0.14	1.4	-	-	-
	T7325	0.4	200	0.18	1.7	155	0.16	1.7	-	-	-	-	-	-	65	0.16	1.4	-	-	-
	T7335	0.4	195	0.18	1.7	150	0.16	1.7	-	-	-	-	-	-	60	0.16	1.4	-	-	-
	T8315	0.4	185	0.17	1.7	110	0.15	1.7	175	0.17	1.7	555	0.20	1.7	45	0.14	1.4	-	-	-
	T8430	0.4	200	0.17	1.7	110	0.15	1.7	165	0.17	1.7	555	0.20	1.7	40	0.14	1.4	-	-	-
	T9325	0.4	250	0.18	1.7	150	0.16	1.7	235	0.18	1.7	-	-	-	55	0.16	1.4	-	-	-
WNMG 080408E-NF	HF7	0.8	-	-	-	110	0.17	1.7	180	0.19	1.7	570	0.23	1.7	-	-	-	-	-	-
	T6310	0.8	200	0.19	1.7	140	0.17	1.7	160	0.19	1.7	600	0.23	1.7	60	0.15	1.4	-	-	-
	T7325	0.8	235	0.19	1.7	180	0.17	1.7	-	-	-	-	-	-	75	0.15	1.4	-	-	-
	T7335	0.8	225	0.19	1.7	175	0.17	1.7	-	-	-	-	-	-	70	0.15	1.4	-	-	-
	T8315	0.8	215	0.19	1.7	125	0.17	1.7	200	0.19	1.7	645	0.23	1.7	50	0.15	1.4	-	-	-
	T8430	0.8	235	0.19	1.7	125	0.17	1.7	190	0.19	1.7	645	0.23	1.7	50	0.15	1.4	-	-	-
	T9315	0.8	320	0.19	1.7	-	-	-	300	0.19	1.7	-	-	-	-	-	-	-	-	-
	T9325	0.8	285	0.19	1.7	170	0.17	1.7	270	0.19	1.7	-	-	-	60	0.15	1.4	-	-	-
WNMG 080412E-NF	T6310	1.2	185	0.30	2.1	130	0.27	2.1	145	0.30	2.1	555	0.36	2.1	55	0.21	1.7	-	-	-
	T7325	1.2	205	0.30	2.1	155	0.27	2.1	-	-	-	-	-	-	65	0.21	1.7	-	-	-
	T8430	1.2	200	0.30	2.1	110	0.27	2.1	165	0.30	2.1	555	0.36	2.1	40	0.21	1.7	-	-	-
	T9315	1.2	275	0.30	2.1	-	-	-	260	0.30	2.1	-	-	-	-	-	-	-	-	-

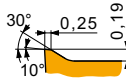

NM geometry with highly positive design for fine-finish, medium and rough machining, with continuous cuts.

WNMG 060404E-NM	T7325	0.4	200	0.20	1.8	155	0.18	1.8	-	-	-	-	-	-	65	0.16	1.4	-	-	-
	T7335	0.4	195	0.20	1.8	150	0.18	1.8	-	-	-	-	-	-	60	0.16	1.4	-	-	-
	T8430	0.4	185	0.25	1.8	100	0.23	1.8	-	-	-	510	0.30	1.8	40	0.20	1.4	-	-	-
	T9325	0.4	245	0.20	1.8	145	0.18	1.8	-	-	-	-	-	-	55	0.16	1.4	-	-	-
WNMG 060408E-NM	T7325	0.8	220	0.25	1.8	170	0.23	1.8	-	-	-	-	-	-	70	0.20	1.4	-	-	-
	T7335	0.8	215	0.25	1.8	165	0.23	1.8	-	-	-	-	-	-	65	0.20	1.4	-	-	-
	T8315	0.8	205	0.25	1.8	120	0.23	1.8	-	-	-	615	0.30	1.8	50	0.20	1.4	-	-	-
	T8430	0.8	220	0.25	1.8	120	0.23	1.8	-	-	-	600	0.30	1.8	45	0.20	1.4	-	-	-
	T9315	0.8	290	0.25	1.8	-	-	-	-	-	-	-	-	-	-	-	-	-	-	-
WNMG 060412E-NM	T9325	0.8	265	0.25	1.8	155	0.23	1.8	-	-	-	-	-	-	55	0.20	1.4	-	-	-
	T7325	1.2	220	0.30	1.8	170	0.27	1.8	-	-	-	-	-	-	70	0.24	1.4	-	-	-
	T7335	1.2	220	0.30	1.2	170	0.27	1.2	-	-	-	-	-	-	70	0.24	1.0	-	-	-
WNMG 080404E-NM	T9325	1.2	255	0.30	1.8	150	0.27	1.8	-	-	-	-	-	-	55	0.24	1.4	-	-	-
	T7325	0.4	195	0.20	2.1	150	0.18	2.1	-	-	-	-	-	-	60	0.16	1.7	-	-	-
	T7335	0.4	190	0.20	2.1	145	0.18	2.1	-	-	-	-	-	-	60	0.16	1.7	-	-	-
	T8315	0.4	180	0.20	2.1	105	0.18	2.1	-	-	-	540	0.24	2.1	45	0.16	1.7	-	-	-
	T8430	0.4	180	0.25	2.1	95	0.23	2.1	-	-	-	495	0.30	2.1	35	0.20	1.7	-	-	-
	T9315	0.4	270	0.20	2.1	-	-	-	-	-	-	-	-	-	-	-	-	-	-	-
WNMG 080408E-NM	T9325	0.4	240	0.20	2.1	140	0.18	2.1	-	-	-	-	-	-	50	0.16	1.7	-	-	-
	T7325	0.8	215	0.25	2.1	165	0.23	2.1	-	-	-	-	-	-	65	0.20	1.7	-	-	-
	T7335	0.8	210	0.25	2.1	160	0.23	2.1	-	-	-	-	-	-	65	0.20	1.7	-	-	-
	T8315	0.8	205	0.25	2.1	120	0.23	2.1	-	-	-	615	0.30	2.1	50	0.20	1.7	-	-	-
	T8430	0.8	210	0.25	2.1	115	0.23	2.1	-	-	-	585	0.30	2.1	45	0.20	1.7	-	-	-
	T9315	0.8	290	0.25	2.1	-	-	-	-	-	-	-	-	-	-	-	-	-	-	-
	T9325	0.8	260	0.25	2.1	155	0.23	2.1	-	-	-	-	-	-	55	0.20	1.7	-	-	-



Suitability and starting values for cutting speed (vc), feed (f) and depth of cut (ap). Refer to our Machining Calculator app for further calculations.

Product	RE  (mm)	P			M			K			N			S			H		
		vc	f	ap	vc	f	ap	vc	f	ap	vc	f	ap	vc	f	ap	vc	f	ap
		(m/min)	(mm/rev)	(mm)	(m/min)	(mm/rev)	(mm)	(m/min)	(mm/rev)	(mm)	(m/min)	(mm/rev)	(mm)	(m/min)	(mm/rev)	(mm)	(m/min)	(mm/rev)	(mm)

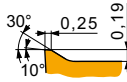

NM geometry with highly positive design for fine-finish, medium and rough machining, with continuous cuts.

WNMG 080412E-NM	T7325	1.2	215	0.30	2.1	165	0.27	2.1	–	–	–	–	–	–	–	65	0.24	1.7	–	–	–
	T7335	1.2	210	0.30	2.1	160	0.27	2.1	–	–	–	–	–	–	–	65	0.24	1.7	–	–	–
	T8315	1.2	205	0.30	2.1	120	0.27	2.1	–	–	–	615	0.36	2.1	50	0.24	1.7	–	–	–	–
	T9325	1.2	255	0.30	2.1	150	0.27	2.1	–	–	–	–	–	–	55	0.24	1.7	–	–	–	–

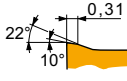

NMR geometry with positive design for medium to rough machining, and continuous cuts.

WNMG 060404E-NMR	T6310	0.4	145	0.25	1.6	100	0.23	1.6	–	–	–	–	–	–	40	0.20	1.3	–	–	–	
	T7325	0.4	160	0.25	1.6	120	0.23	1.6	–	–	–	–	–	–	50	0.20	1.3	–	–	–	
	T8430	0.4	165	0.25	1.6	90	0.23	1.6	–	–	–	–	–	35	0.20	1.3	–	–	–	–	
	T9325	0.4	200	0.25	1.6	120	0.23	1.6	–	–	–	–	–	45	0.20	1.3	–	–	–	–	
	T9315	0.4	225	0.25	1.6	–	–	–	–	–	–	–	–	–	–	–	–	–	–	–	–
WNMG 060408E-NMR	T6310	0.8	155	0.35	1.6	110	0.32	1.6	–	–	–	–	–	–	45	0.25	1.3	–	–	–	
	T7325	0.8	175	0.35	1.6	135	0.32	1.6	–	–	–	–	–	–	55	0.25	1.3	–	–	–	
	T7335	0.8	170	0.35	1.6	130	0.32	1.6	–	–	–	–	–	–	55	0.25	1.3	–	–	–	
	T9315	0.8	225	0.35	1.6	–	–	–	–	–	–	–	–	–	–	–	–	–	–	–	–
	T9325	0.8	200	0.35	1.6	120	0.32	1.6	–	–	–	–	–	–	45	0.25	1.3	–	–	–	
WNMG 080404E-NMR	T6310	0.4	140	0.25	2.7	100	0.23	2.7	–	–	–	–	–	–	40	0.20	2.2	–	–	–	
	T7325	0.4	155	0.25	2.7	120	0.23	2.7	–	–	–	–	–	–	50	0.20	2.2	–	–	–	
	T7335	0.4	150	0.25	2.7	115	0.23	2.7	–	–	–	–	–	–	45	0.20	2.2	–	–	–	
	T8430	0.4	150	0.25	2.7	80	0.23	2.7	–	–	–	–	–	–	30	0.20	2.2	–	–	–	
	T9315	0.4	205	0.25	2.7	–	–	–	–	–	–	–	–	–	–	–	–	–	–	–	–
WNMG 080408E-NMR	T6310	0.8	150	0.35	2.7	105	0.32	2.7	–	–	–	–	–	–	45	0.25	2.2	–	–	–	
	T7325	0.8	170	0.35	2.7	130	0.32	2.7	–	–	–	–	–	–	55	0.25	2.2	–	–	–	
	T7335	0.8	160	0.35	2.7	120	0.32	2.7	–	–	–	–	–	–	50	0.25	2.2	–	–	–	
	T8430	0.8	155	0.35	2.7	85	0.32	2.7	–	–	–	–	–	–	30	0.25	2.2	–	–	–	
	T9315	0.8	210	0.35	2.7	–	–	–	–	–	–	–	–	–	–	–	–	–	–	–	–
WNMG 080412E-NMR	T6310	1.2	150	0.40	2.7	105	0.36	2.7	–	–	–	–	–	–	45	0.28	2.2	–	–	–	
	T7325	1.2	170	0.40	2.7	130	0.36	2.7	–	–	–	–	–	–	55	0.28	2.2	–	–	–	
	T7335	1.2	160	0.40	2.7	120	0.36	2.7	–	–	–	–	–	–	50	0.28	2.2	–	–	–	
	T8430	1.2	155	0.40	2.7	85	0.36	2.7	–	–	–	–	–	–	30	0.28	2.2	–	–	–	
	T9315	1.2	215	0.40	2.7	–	–	–	–	–	–	–	–	–	–	–	–	–	–	–	–
T9325	1.2	190	0.40	2.7	110	0.36	2.7	–	–	–	–	–	–	40	0.28	2.2	–	–	–	–	

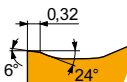

NRM geometry with positive design for semi-rough to rough machining, and continuous to moderate interrupted cuts.

WNMG 080408-NRM	T7325	0.8	170	0.35	2.7	130	0.32	2.7	–	–	–	–	–	–	55	0.28	2.2	–	–	–
	T7335	0.8	160	0.35	2.7	120	0.32	2.7	–	–	–	–	–	–	50	0.28	2.2	–	–	–
	T9315	0.8	210	0.35	2.7	–	–	–	–	–	–	–	–	–	–	–	–	–	–	–
WNMG 080412-NRM	T7325	1.2	170	0.40	2.7	130	0.36	2.7	–	–	–	–	–	–	55	0.28	2.2	–	–	–
	T9315	1.2	215	0.40	2.7	–	–	–	–	–	–	–	–	–	–	–	–	–	–	–

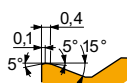

R geometry for semi-rough to rough machining, and continuous to interrupted cuts.

WNMG 080408E-R	T5305	0.8	245	0.40	3.5	–	–	–	230	0.40	3.5	–	–	–	–	–	–	45	0.20	0.7
	T5315	0.8	220	0.40	3.5	–	–	–	205	0.40	3.5	–	–	–	–	–	–	40	0.20	0.7
	T9310	0.8	210	0.40	3.5	–	–	–	195	0.40	3.5	–	–	–	–	–	–	40	0.20	0.7
	T9315	0.8	195	0.40	3.5	–	–	–	185	0.40	3.5	–	–	–	–	–	–	35	0.20	0.7
	T9325	0.8	175	0.40	3.5	–	–	–	165	0.40	3.5	–	–	–	–	–	–	–	–	–
	T9335	0.8	155	0.40	3.5	–	–	–	–	–	–	–	–	–	–	–	–	–	–	–

BN

CN

DN

LN

SN

TN

VN

WN



Suitability and starting values for cutting speed (vc), feed (f) and depth of cut (ap). Refer to our Machining Calculator app for further calculations.

Product	RE (mm)	P			M			K			N			S			H		
		vc (m/min)	f (mm/rev)	ap (mm)	vc (m/min)	f (mm/rev)	ap (mm)	vc (m/min)	f (mm/rev)	ap (mm)	vc (m/min)	f (mm/rev)	ap (mm)	vc (m/min)	f (mm/rev)	ap (mm)	vc (m/min)	f (mm/rev)	ap (mm)

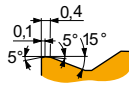

R geometry for semi-rough to rough machining, and continuous to interrupted cuts.

WNMG 080412E-R	T5305	1.2	250	0.45	3.5				235	0.45	3.5						50	0.23	1.0
	T5315	1.2	225	0.45	3.5				210	0.45	3.5						45	0.23	1.0
	T9310	1.2	215	0.45	3.5				200	0.45	3.5						40	0.23	1.0
	T9315	1.2	200	0.45	3.5				190	0.45	3.5						40	0.23	1.0
	T9325	1.2	180	0.45	3.5				170	0.45	3.5								
	T9335	1.2	155	0.45	3.5														

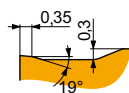

RM geometry for semi-rough to rough machining, and continuous to interrupted cuts.

WNMG 060412E-RM	T9315	1.2	230	0.45	3.0				215	0.45	3.0								
	T9325	1.2	230	0.45	1.2	135	0.41	1.2	215	0.45	1.2								
WNMG 080408E-RM	T5305	0.8	275	0.40	4.0				260	0.40	4.0								
	T5315	0.8	250	0.40	4.0				235	0.40	4.0								
	T7325	0.8	180	0.40	4.0	140	0.36	4.0											
	T7335	0.8	165	0.40	4.0	125	0.36	4.0											
	T8315	0.8	165	0.40	4.0	95	0.36	4.0	155	0.40	4.0								
	T8430	0.8	165	0.40	4.0	90	0.36	4.0	135	0.40	4.0								
	T9310	0.8	240	0.40	4.0				225	0.40	4.0								
	T9315	0.8	220	0.40	4.0				205	0.40	4.0								
	T9325	0.8	200	0.40	4.0	120	0.36	4.0	190	0.40	4.0								
	T9335	0.8	170	0.40	4.0	100	0.36	4.0											
WNMG 080412E-RM	T5305	1.2	280	0.45	4.0				265	0.45	4.0								
	T5315	1.2	250	0.45	4.0				235	0.45	4.0								
	T8315	1.2	170	0.45	4.0	100	0.41	4.0	160	0.45	4.0								
	T9310	1.2	240	0.45	4.0				225	0.45	4.0								
	T9315	1.2	220	0.45	4.0				205	0.45	4.0								
	T9325	1.2	200	0.45	4.0	120	0.41	4.0	190	0.45	4.0								
WNMG 080416E-RM	T5305	1.6	280	0.50	4.0				265	0.50	4.0								
	T5315	1.6	255	0.50	4.0				240	0.50	4.0								
	T8430	1.6	170	0.50	4.0	90	0.45	4.0	135	0.50	4.0								
	T9310	1.6	240	0.50	4.0				225	0.50	4.0								
	T9315	1.6	220	0.50	4.0				205	0.50	4.0								
	T9325	1.6	205	0.50	4.0	120	0.45	4.0	190	0.50	4.0								

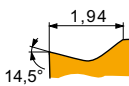

SF geometry with positive design for fine-finish machining and for machining thin walls, with continuous cuts.

WNMG 060404E-SF	T6310	0.4	180	0.15	1.0	125	0.14	1.0	145	0.15	1.0	540	0.18	1.0	50	0.12	0.8	35	0.11	0.3
	T8315	0.4	195	0.15	1.0	115	0.14	1.0	185	0.15	1.0	585	0.18	1.0	45	0.12	0.8	35	0.11	0.3
	T8430	0.4	220	0.15	1.0	120	0.14	1.0	180	0.15	1.0	600	0.18	1.0	45	0.12	0.8	35	0.11	0.3
WNMG 060408E-SF	T6310	0.8	200	0.20	1.0	140	0.18	1.0	160	0.20	1.0	600	0.24	1.0	60	0.14	0.8	40	0.10	0.7
	T8315	0.8	210	0.20	1.0	125	0.18	1.0	195	0.20	1.0	630	0.24	1.0	50	0.14	0.8	40	0.10	0.7
	T8430	0.8	230	0.20	1.0	125	0.18	1.0	185	0.20	1.0	630	0.24	1.0	45	0.14	0.8	35	0.10	0.7
WNMG 080404E-SF	H07	0.4				90	0.14	1.0	145	0.15	1.0	470	0.18	1.0	45	0.12	0.8			
	T6310	0.4	180	0.15	1.0	125	0.14	1.0	145	0.15	1.0	540	0.18	1.0	50	0.12	0.8	35	0.11	0.3
	T7325	0.4	205	0.17	1.0	155	0.15	1.0							65	0.15	0.8			
	T8315	0.4	195	0.15	1.0	115	0.14	1.0	185	0.15	1.0	585	0.18	1.0	45	0.12	0.8	35	0.11	0.3
	T8430	0.4	220	0.15	1.0	120	0.14	1.0	180	0.15	1.0	600	0.18	1.0	45	0.12	0.8	35	0.11	0.3



Suitability and starting values for cutting speed (vc), feed (f) and depth of cut (ap). Refer to our Machining Calculator app for further calculations.

Product	RE (mm)	P			M			K			N			S			H		
		vc (m/min)	f (mm/rev)	ap (mm)	vc (m/min)	f (mm/rev)	ap (mm)	vc (m/min)	f (mm/rev)	ap (mm)	vc (m/min)	f (mm/rev)	ap (mm)	vc (m/min)	f (mm/rev)	ap (mm)	vc (m/min)	f (mm/rev)	ap (mm)

14,5°

1,94

E

SF geometry with positive design for fine-finish machining and for machining thin walls, with continuous cuts.

WNMG 080408E-SF	H07	0.8	—	—	—	95	0.18	1.0	155	0.20	1.0	495	0.24	1.0	50	0.14	0.8	—	—	—
	T6310	0.8	200	0.20	1.0	140	0.18	1.0	160	0.20	1.0	600	0.24	1.0	60	0.14	0.8	40	0.10	0.7
	T7325	0.8	230	0.20	1.0	175	0.18	1.0	—	—	—	—	—	—	70	0.16	0.8	—	—	—
	T7335	0.8	220	0.20	1.0	170	0.18	1.0	—	—	—	—	—	—	70	0.16	0.8	—	—	—
	T8315	0.8	210	0.20	1.0	125	0.18	1.0	195	0.20	1.0	630	0.24	1.0	50	0.14	0.8	40	0.10	0.7
	T8430	0.8	230	0.20	1.0	125	0.18	1.0	185	0.20	1.0	630	0.24	1.0	45	0.14	0.8	35	0.10	0.7
	T9315	0.8	315	0.20	1.0	—	—	—	295	0.20	1.0	—	—	—	—	—	—	60	0.13	0.7
	T9325	0.8	280	0.20	1.0	165	0.18	1.0	265	0.20	1.0	—	—	—	60	0.16	0.8	—	—	—

13°

5°

0,25

S

SM geometry with positive design for medium machining, and continuous to interrupted cuts.

WNMG 060404E-SM	T7335	0.4	180	0.20	1.7	140	0.18	1.7	—	—	—	—	—	—	55	0.18	1.4	—	—	—
	T8430	0.4	185	0.20	1.7	100	0.18	1.7	150	0.20	1.7	510	0.24	1.7	40	0.18	1.4	30	0.13	0.3
	T9325	0.4	225	0.20	1.7	135	0.18	1.7	210	0.20	1.7	—	—	—	50	0.18	1.4	—	—	—
WNMG 060408E-SM	T6310	0.8	175	0.25	1.7	125	0.23	1.7	140	0.25	1.7	525	0.30	1.7	50	0.20	1.4	35	0.13	0.7
	T7325	0.8	200	0.25	1.7	155	0.23	1.7	—	—	—	—	—	65	0.20	1.4	—	—	—	
	T7335	0.8	195	0.25	1.7	150	0.23	1.7	—	—	—	—	—	60	0.20	1.4	—	—	—	
	T8430	0.8	195	0.25	1.7	105	0.23	1.7	160	0.25	1.7	540	0.30	1.7	40	0.20	1.4	30	0.13	0.7
	T9325	0.8	240	0.25	1.7	140	0.23	1.7	225	0.25	1.7	—	—	—	50	0.20	1.4	—	—	—
WNMG 060412E-SM	T8430	1.2	195	0.30	1.7	105	0.27	1.7	160	0.30	1.7	540	0.36	1.7	40	0.24	1.4	30	0.15	1.0
	T9325	1.2	240	0.30	1.7	140	0.27	1.7	225	0.30	1.7	—	—	—	50	0.24	1.4	—	—	—
WNMG 080404E-SM	T6310	0.4	155	0.20	2.0	110	0.18	2.0	125	0.20	2.0	465	0.24	2.0	45	0.18	1.6	30	0.13	0.3
	T7325	0.4	180	0.20	2.0	140	0.18	2.0	—	—	—	—	—	55	0.18	1.6	—	—	—	
	T7335	0.4	175	0.20	2.0	135	0.18	2.0	—	—	—	—	—	55	0.18	1.6	—	—	—	
	T8430	0.4	180	0.20	2.0	95	0.18	2.0	145	0.20	2.0	495	0.24	2.0	35	0.18	1.6	30	0.13	0.3
	T9315	0.4	245	0.20	2.0	—	—	—	230	0.20	2.0	—	—	—	—	—	—	45	0.13	0.3
	T9325	0.4	220	0.20	2.0	130	0.18	2.0	205	0.20	2.0	—	—	—	45	0.18	1.6	—	—	—
	T9325	0.4	220	0.20	2.0	130	0.18	2.0	205	0.20	2.0	—	—	—	45	0.18	1.6	—	—	—
WNMG 080408E-SM	T6310	0.8	175	0.25	2.0	125	0.23	2.0	140	0.25	2.0	525	0.30	2.0	50	0.20	1.6	35	0.13	0.7
	T7325	0.8	200	0.25	2.0	155	0.23	2.0	—	—	—	—	—	65	0.20	1.6	—	—	—	
	T7335	0.8	190	0.25	2.0	145	0.23	2.0	—	—	—	—	—	60	0.20	1.6	—	—	—	
	T8430	0.8	195	0.25	2.0	105	0.23	2.0	160	0.25	2.0	540	0.30	2.0	40	0.20	1.6	30	0.13	0.7
	T9315	0.8	265	0.25	2.0	—	—	—	250	0.25	2.0	—	—	—	—	—	—	50	0.13	0.7
	T9325	0.8	235	0.25	2.0	140	0.23	2.0	220	0.25	2.0	—	—	—	50	0.20	1.6	—	—	—
	T9325	0.8	235	0.25	2.0	140	0.23	2.0	220	0.25	2.0	—	—	—	50	0.20	1.6	—	—	—
WNMG 080412E-SM	T6310	1.2	175	0.30	2.0	125	0.27	2.0	140	0.30	2.0	525	0.36	2.0	50	0.24	1.6	35	0.15	1.0
	T7325	1.2	195	0.30	2.0	150	0.27	2.0	—	—	—	—	—	60	0.24	1.6	—	—	—	
	T7335	1.2	190	0.30	2.0	145	0.27	2.0	—	—	—	—	—	60	0.24	1.6	—	—	—	
	T8430	1.2	190	0.30	2.0	105	0.27	2.0	155	0.30	2.0	525	0.36	2.0	40	0.24	1.6	30	0.15	1.0
	T9315	1.2	260	0.30	2.0	—	—	—	245	0.30	2.0	—	—	—	—	—	—	50	0.15	1.0
	T9325	1.2	235	0.30	2.0	140	0.27	2.0	220	0.30	2.0	—	—	—	50	0.24	1.6	—	—	—
	T9325	1.2	235	0.30	2.0	140	0.27	2.0	220	0.30	2.0	—	—	—	50	0.24	1.6	—	—	—

15°-18°

E

ER-SI geometry with positive right-handed geometry for fine-finish to semi-rough machining, and continuous cuts.

WNMG 060404ER-SI	T8430	0.4	225	0.20	1.7	120	0.18	1.7	—	—	—	615	0.24	1.7	45	0.18	1.4	—	—	—
	T9325	0.4	270	0.20	1.7	160	0.18	1.7	—	—	—	—	—	60	0.18	1.4	—	—	—	
WNMG 080404ER-SI	T7325	0.4	220	0.20	1.7	170	0.18	1.7	—	—	—	—	—	70	0.18	1.4	—	—	—	
	T7335	0.4	215	0.20	1.7	165	0.18	1.7	—	—	—	—	—	65	0.18	1.4	—	—	—	
	T8315	0.4	205	0.20	1.7	120	0.18	1.7	—	—	—	615	0.24	1.7	50	0.18	1.4	—	—	—
	T8430	0.4	225	0.20	1.7	120	0.18	1.7	—	—	—	615	0.24	1.7	45	0.18	1.4	—	—	—
	T9325	0.4	270	0.20	1.7	160	0.18	1.7	—	—	—	—	—	60	0.18	1.4	—	—	—	
	T9325	0.4	270	0.20	1.7	160	0.18	1.7	—	—	—	—	—	60	0.18	1.4	—	—	—	



Suitability and starting values for cutting speed (vc), feed (f) and depth of cut (ap). Refer to our Machining Calculator app for further calculations.

Product	RE (mm)	P			M			K			N			S			H		
		vc	f	ap	vc	f	ap	vc	f	ap	vc	f	ap	vc	f	ap	vc	f	ap
		(m/min)	(mm/rev)	(mm)	(m/min)	(mm/rev)	(mm)	(m/min)	(mm/rev)	(mm)	(m/min)	(mm/rev)	(mm)	(m/min)	(mm/rev)	(mm)	(m/min)	(mm/rev)	(mm)

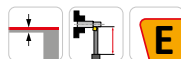
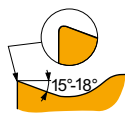

ER-SI geometry with positive right-handed geometry for fine-finish to semi-rough machining, and continuous cuts.

WNMG 080408ER-SI	T7325	0.8	215	0.35	1.7	165	0.32	1.7	-	-	-	-	-	65	0.25	1.4	-	-	-	
	T7335	0.8	205	0.35	1.7	155	0.32	1.7	-	-	-	-	-	65	0.25	1.4	-	-	-	
	T8315	0.8	205	0.35	1.7	120	0.32	1.7	-	-	-	615	0.42	1.7	50	0.25	1.4	-	-	-
	T8430	0.8	210	0.35	1.7	115	0.32	1.7	-	-	-	585	0.42	1.7	45	0.25	1.4	-	-	-
WNMG 080412ER-SI	T9325	0.8	255	0.35	1.7	150	0.32	1.7	-	-	-	-	-	55	0.25	1.4	-	-	-	
	T8430	1.2	225	0.35	1.7	120	0.32	1.7	-	-	-	615	0.42	1.7	45	0.25	1.4	-	-	-

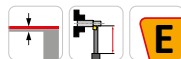
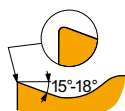

EL-SI geometry with positive left-handed design for fine-finish to semi-rough machining, and continuous cuts.

WNMG 060404EL-SI	T8430	0.4	225	0.20	1.7	120	0.18	1.7	-	-	-	615	0.24	1.7	45	0.18	1.4	-	-	-
	T9325	0.4	270	0.20	1.7	160	0.18	1.7	-	-	-	-	-	60	0.18	1.4	-	-	-	
WNMG 080404EL-SI	T7325	0.4	220	0.20	1.7	170	0.18	1.7	-	-	-	-	-	70	0.18	1.4	-	-	-	
	T7335	0.4	215	0.20	1.7	165	0.18	1.7	-	-	-	-	-	65	0.18	1.4	-	-	-	
	T8315	0.4	205	0.20	1.7	120	0.18	1.7	-	-	-	615	0.24	1.7	50	0.18	1.4	-	-	-
	T8430	0.4	225	0.20	1.7	120	0.18	1.7	-	-	-	615	0.24	1.7	45	0.18	1.4	-	-	-
WNMG 080408EL-SI	T9325	0.4	270	0.20	1.7	160	0.18	1.7	-	-	-	-	-	60	0.18	1.4	-	-	-	
	T7325	0.8	215	0.35	1.7	165	0.32	1.7	-	-	-	-	-	65	0.25	1.4	-	-	-	
	T7335	0.8	205	0.35	1.7	155	0.32	1.7	-	-	-	-	-	65	0.25	1.4	-	-	-	
	T8315	0.8	205	0.35	1.7	120	0.32	1.7	-	-	-	615	0.42	1.7	50	0.25	1.4	-	-	-
WNMG 080412EL-SI	T8430	0.8	210	0.35	1.7	115	0.32	1.7	-	-	-	585	0.42	1.7	45	0.25	1.4	-	-	-
	T9325	0.8	255	0.35	1.7	150	0.32	1.7	-	-	-	-	-	55	0.25	1.4	-	-	-	
	T8430	1.2	225	0.35	1.7	120	0.32	1.7	-	-	-	615	0.42	1.7	45	0.25	1.4	-	-	-

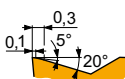

W-M wiper geometry for semi-rough to rough machining with increased feed rates and improved surface finish.

WNMG 060408W-M	T9310	0.8	220	0.45	1.2	-	-	-	205	0.45	1.2	-	-	-	-	-	-	-	-
	T9315	0.8	205	0.45	1.2	-	-	-	190	0.45	1.2	-	-	-	-	-	-	-	-
	T9325	0.8	190	0.45	1.2	-	-	-	180	0.45	1.2	-	-	-	-	-	-	-	-
WNMG 060412W-M	T5315	1.2	235	0.55	1.2	-	-	-	220	0.55	1.2	-	-	-	-	-	-	-	-
	T9315	1.2	205	0.55	1.2	-	-	-	190	0.55	1.2	-	-	-	-	-	-	-	-
WNMG 080408W-M	T9315	0.8	200	0.45	1.5	-	-	-	190	0.45	1.5	-	-	-	-	-	-	-	-
	T9325	0.8	185	0.45	1.5	-	-	-	175	0.45	1.5	-	-	-	-	-	-	-	-
WNMG 080412W-M	T9325	1.2	180	0.55	1.5	-	-	-	170	0.55	1.5	-	-	-	-	-	-	-	-

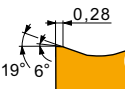

W-MR wiper geometry for finish to rough machining with increased feed rates and improved surface finish.

WNMG 060408W-MR	T9315	0.8	205	0.45	1.2	-	-	-	190	0.45	1.2	-	-	-	-	-	-	-	-
	T9325	0.8	190	0.45	1.2	110	0.41	1.2	180	0.45	1.2	-	-	-	-	-	-	-	-
WNMG 080404W-MR	T9315	0.4	200	0.30	1.5	-	-	-	190	0.30	1.5	-	-	-	-	-	-	-	-
WNMG 080408W-MR	T5315	0.8	230	0.45	1.5	-	-	-	215	0.45	1.5	-	-	-	-	-	-	-	-
	T9310	0.8	215	0.45	1.5	-	-	-	200	0.45	1.5	-	-	-	-	-	-	-	-
	T9315	0.8	200	0.45	1.5	-	-	-	190	0.45	1.5	-	-	-	-	-	-	-	-
	T9325	0.8	185	0.45	1.5	110	0.41	1.5	175	0.45	1.5	-	-	-	-	-	-	-	-
WNMG 080412W-MR	T5315	1.2	230	0.55	1.5	-	-	-	215	0.55	1.5	-	-	-	-	-	-	-	-
	T9310	1.2	210	0.55	1.5	-	-	-	195	0.55	1.5	-	-	-	-	-	-	-	-
	T9315	1.2	200	0.55	1.5	-	-	-	190	0.55	1.5	-	-	-	-	-	-	-	-



WNMM



	IC	D1	L	S
	(mm)	(mm)	(mm)	(mm)
0804	12.700	5.16	8.70	4.76
1306	19.050	7.94	13.00	6.35

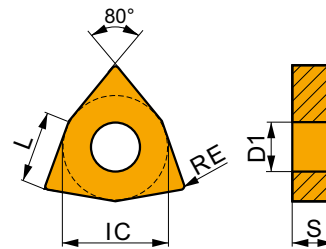

Suitability and starting values for cutting speed (vc), feed (f) and depth of cut (ap). Refer to our Machining Calculator app for further calculations.

Product	RE (mm)	P			M			K			N			S			H		
		vc (m/min)	f (mm/rev)	ap (mm)	vc (m/min)	f (mm/rev)	ap (mm)	vc (m/min)	f (mm/rev)	ap (mm)	vc (m/min)	f (mm/rev)	ap (mm)	vc (m/min)	f (mm/rev)	ap (mm)	vc (m/min)	f (mm/rev)	ap (mm)

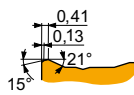

NR2 geometry for semi-rough to rough machining, and continuous to interrupted cuts.

WNMM 080408E-NR2	T7335	0.8	160	0.40	4.0	120	0.36	4.0	—	—	—	—	—	—	50	0.28	3.2	—	—	—
	T9325	0.8	190	0.40	4.0	110	0.36	4.0	180	0.40	4.0	—	—	—	40	0.28	3.2	—	—	—
WNMM 080412E-NR2	T9325	1.2	190	0.45	4.0	110	0.41	4.0	180	0.45	4.0	—	—	—	40	0.32	3.2	—	—	—

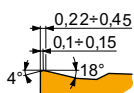

OR geometry for semi-rough to rough machining, and continuous to interrupted cuts.

WNMM 080408E-OR	T8430	0.8	155	0.40	4.0	85	0.36	4.0	130	0.40	4.0	—	—	—	30	0.28	3.2	—	—	—
	T9325	0.8	190	0.40	4.0	110	0.36	4.0	180	0.40	4.0	—	—	—	40	0.28	3.2	—	—	—
	T9335	0.8	165	0.40	4.0	95	0.36	4.0	—	—	—	—	—	—	35	0.28	3.2	—	—	—
WNMM 080412E-OR	T9325	1.2	190	0.45	4.0	110	0.41	4.0	180	0.45	4.0	—	—	—	40	0.36	3.2	—	—	—
WNMM 080416E-OR	T9325	1.6	195	0.50	4.0	115	0.45	4.0	185	0.50	4.0	—	—	—	40	0.40	3.2	—	—	—
WNMM 130612E-OR	T9325	1.2	185	0.45	6.0	110	0.41	6.0	175	0.45	6.0	—	—	—	40	0.36	4.8	—	—	—
WNMM 130616E-OR	T9325	1.6	180	0.50	6.0	105	0.45	6.0	170	0.50	6.0	—	—	—	40	0.40	4.8	—	—	—

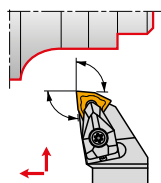

DWLN(RL) EXT

External Double Clamp Holder with 95° Cutting Angle for WN.. Insert

External Right/Left hand double clamp turning holder with 95° cutting angle. Suited for longitudinal turning with shoulder, face, taper and chamfer turning with negative WN.. 06 to 13 inserts. Available with shank size 16x16 up to 40x40 mm. Body treated for longer tool life.

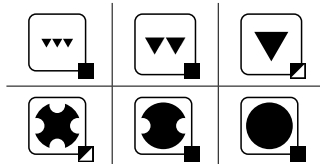
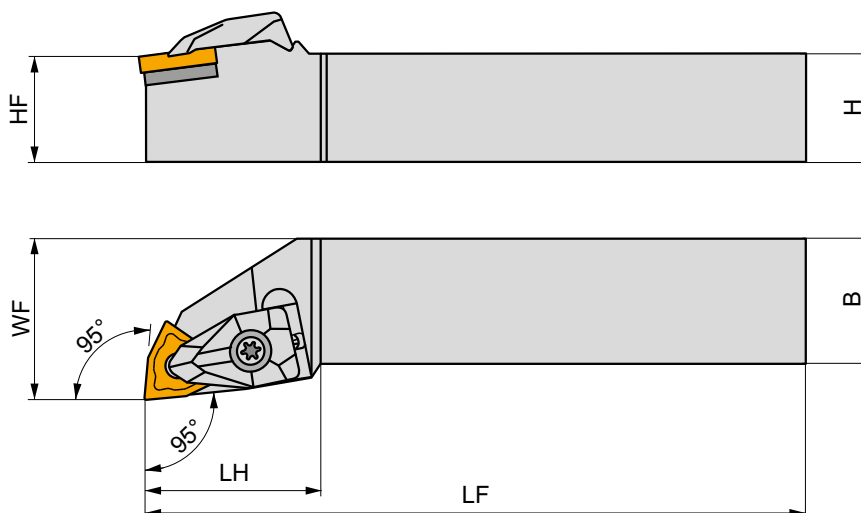

Product	H	B	HF	WF	LF	LH	LAMS	GAMO	kg				
	(mm)	(mm)	(mm)	(mm)	(mm)	(mm)	(°)	(°)					
R	DWLN R 1616 H 06	16	16	16	20	100	26.4	-6	-6	0.22	GI028	DW06	-
	DWLN R 2020 K 06	20	20	20	25	125	27.1	-6	-6	0.41	GI028	DW06	-
	DWLN R 2525 M 06	25	25	25	32	150	27.1	-6	-6	0.75	GI028	DW06	-
	DWLN R 2020 K 08	20	20	20	25	125	34.3	-6	-6	0.43	GI072	DW08	AT004
	DWLN R 2525 M 08	25	25	25	32	150	35	-6	-6	0.75	GI072	DW08	AT004
	DWLN R 3225 P 08	32	25	32	32	170	35	-6	-6	1.01	GI072	DW08	AT004
	DWLN R 3225 P 10	32	25	32	32	170	38	-6	-6	1.06	GI166	DW10	-
	DWLN R 3232 P 13	32	32	32	40	170	40	-6	-6	1.44	GI167	DW13	-
	DWLN R 4040 S 13	40	40	40	50	250	41	-6	-6	3.19	GI167	DW13	-
	L	DWLN L 1616 H 06	16	16	16	20	100	26.4	-6	-6	0.22	GI028	DW06
DWLN L 2020 K 06		20	20	20	25	125	27.1	-6	-6	0.41	GI028	DW06	-
DWLN L 2525 M 06		25	25	25	32	150	27.1	-6	-6	0.76	GI028	DW06	-
DWLN L 2020 K 08		20	20	20	25	125	34.3	-6	-6	0.43	GI072	DW08	AT004
DWLN L 2525 M 08		25	25	25	32	150	35	-6	-6	0.75	GI072	DW08	AT004
DWLN L 3225 P 08		32	25	32	32	170	35	-6	-6	1.10	GI072	DW08	AT004
DWLN L 3225 P 10		32	25	32	32	170	38	-6	-6	1.14	GI166	DW10	-
DWLN L 3232 P 13		32	32	32	40	170	40	-6	-6	1.45	GI167	DW13	-
DWLN L 4040 S 13		40	40	40	50	250	41	-6	-6	3.17	GI167	DW13	-



GI028

WN.. 0604..

GI072

WN.. 0804..







GI166



WN.. 1006..

GI167

WN.. 1306..



		 Nm				
DW06	DCS 09	1.7	DWS 328-01	US 2004-T09P	FLAG T09P	–
DW08	DCS 12	3.9	DWS 331-12	US 2002-T15P	FLAG T15P/3,5	–
DW10	DCS 16	6.4	DWN 100612	US 5018-T20P	–	LK T20P
DW13	DCS 19	6.4	DWN 130612	US 6013-T20P	–	LK T20P

		
AT004a	CER WN.N 0804..	DCS 12C4
AT004b	CER WN.A 0804..	DCS 12C2



MWLN(RL) EXT



PRAMET

M



External Multi-Clamp Holder with 95° Cutting Angle for WN.. Insert

External Right/Left hand multi-clamp turning holder with 95° cutting angle. Suited for longitudinal turning with shoulder, face, taper and chamfer turning with negative WN.. 08 inserts. Available with shank size 25x25 up to 40x40 mm. Body treated for longer tool life.

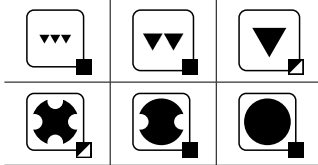
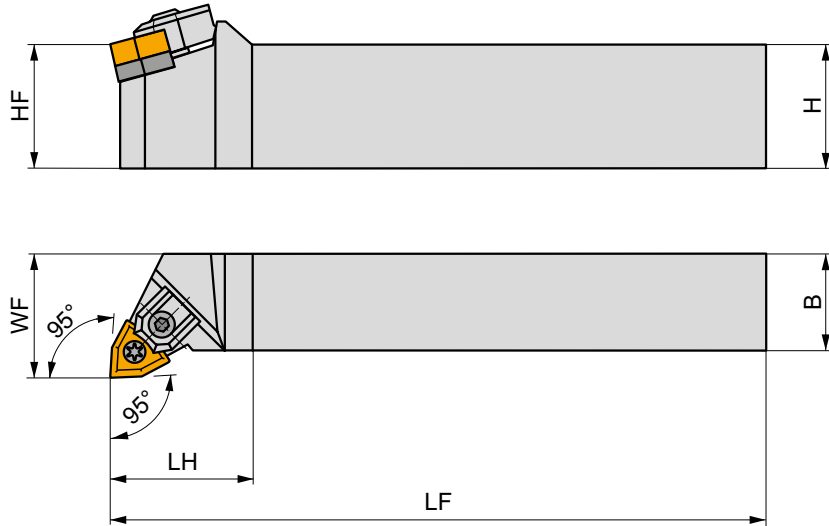
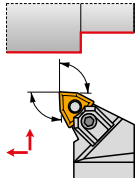

Product	H	B	HF	WF	LF	LH	LAMS	GAMO	kg	GI072	MW1
	(mm)	(mm)	(mm)	(mm)	(mm)	(mm)	(°)	(°)			
R MWLNR 2525 M 08	25	25	25	32	150	32	-6	-6	0.73	GI072	MW1
MWLNR 3225 P 08	32	25	32	32	170	32	-6	-6	1.30	GI072	MW1
MWLNR 4040 S 08	40	40	40	50	250	32	-6	-6	2.50	GI072	MW1
L MWLNL 2525 M 08	25	25	25	32	150	32	-6	-6	0.70	GI072	MW1
MWLNL 3225 P 08	32	25	32	32	170	32	-6	-6	1.02	GI072	MW1
MWLNL 4040 S 08	40	40	40	50	250	32	-6	-6	2.50	GI072	MW1



GI072



WN..0804..



MW1



UE 05



5.0



WNW 080412



UC 51



HS 0408

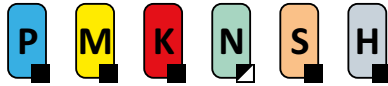

HXK 3

**PWLN(RL) EXT**

PRAMET

P**External Lever Lock Holder with 95° Cutting Angle for WN.. Insert**

External Right/Left hand lever lock turning holder with 95° cutting angle. Suited for longitudinal turning with shoulder, face, taper and chamfer turning with negative WN.. 06 and 08 inserts. Available with shank size 16x16 up to 32x25 mm. Body treated for longer tool life.

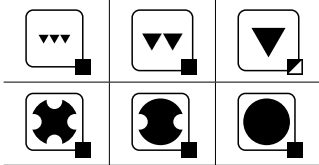
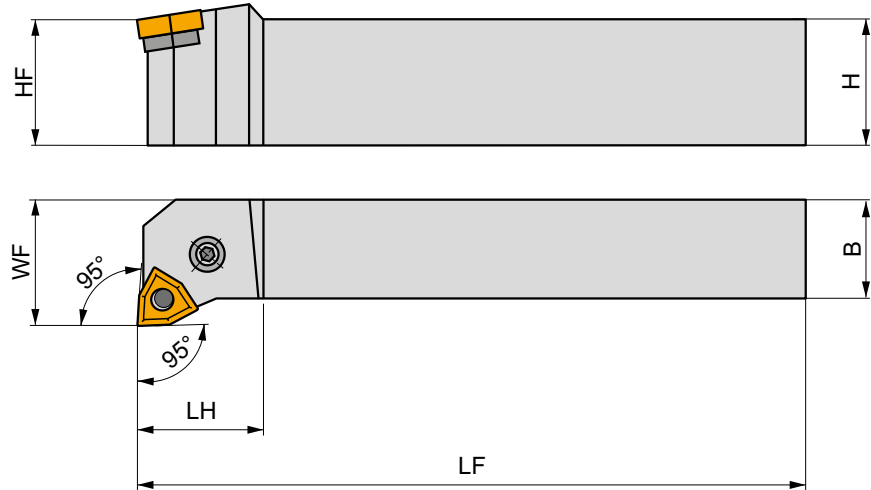
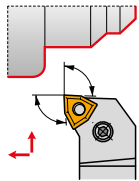

	Product	≡	B	HF	WF	LF	LH	LAMS	GAMO	kg		
		(mm)	(mm)	(mm)	(mm)	(mm)	(mm)	(°)	(°)			
R	PWLN R 1616 H 0604	16	16	16	20	100	20	-6	-6	0.23	G1028	PW11
	PWLN R 2020 K 0604	20	20	20	25	125	20	-6	-6	0.40	G1028	PW10
	PWLN R 2525 M 0604	25	25	25	32	150	20	-6	-6	0.78	G1028	PW10
	PWLN R 2020 K 08	20	20	20	25	125	22	-6	-6	0.42	G1072	PW22
	PWLN R 2525 M 08	25	25	25	32	150	22	-6	-6	0.73	G1072	PW20
	PWLN R 3225 P 08	32	25	32	32	170	22	-6	-6	1.05	G1072	PW20
L	PWLN L 1616 H 0604	16	16	16	20	100	20	-6	-6	0.21	G1028	PW11
	PWLN L 2020 K 0604	20	20	20	25	125	20	-6	-6	0.40	G1028	PW10
	PWLN L 2525 M 0604	25	25	25	32	150	20	-6	-6	0.75	G1028	PW10
	PWLN L 2020 K 08	20	20	20	25	125	22	-6	-6	0.40	G1072	PW22
	PWLN L 2525 M 08	25	25	25	32	150	22	-6	-6	0.74	G1072	PW20
	PWLN L 3225 P 08	32	25	32	32	170	22	-6	-6	1.05	G1072	PW20

G1028
G1072WN.. 0604..
WN.. 0804..PW10
PW11
PW20
PW22WNU 060308
WNU 060308
WNU 080312
WNU 080312PU 01
PU 01
PU 02
PU 02US 34
US 46
US 35
US 425.0
5.0
6.0
6.0M 6x0.75
M 6x0.75
M 8x1
M 8x119
13.2
22.5
21NT 04
NT 04
NT 05
NT 05MT 04
MT 04
MT 05
MT 05HXK 3
HXK 3
HXK 4
HXK 4



C.-DWLN(RL) EXT

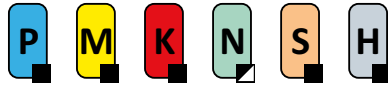

External PSC Quick Change Tool, Double Clamp, 95° Cutting Angle, WN.. Ins

External Right/Left hand double clamp tool, through coolant, with 95° cutting angle for face and longitudinal turning with shoulder, taper and chamfering with negative WN.. 06 and 08 inserts. Available with PSC (Polygon Shank Coupling) size C4 up to C6. Body treated for longer tool life.

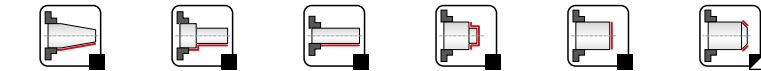
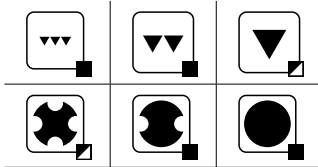
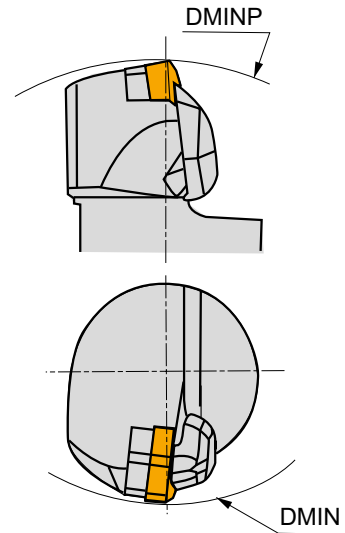
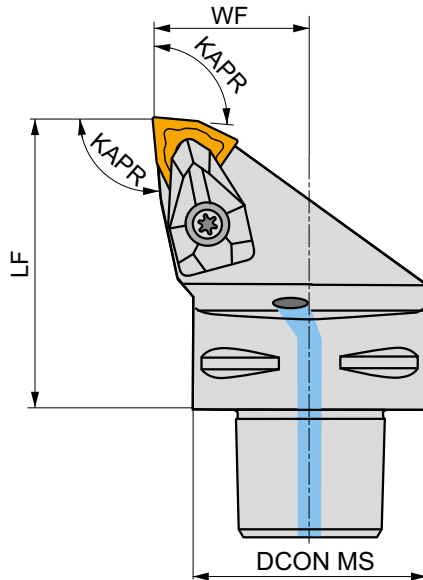
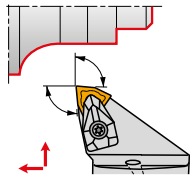

Product	DCON MS	DMIN	DMINP	WF	LF	KAPR	LAMS	GAMO					
	(mm)	(mm)	(mm)	(mm)	(mm)	(°)	(°)	(°)					
R C4-DWLN-27050-06	40	60	140	27	50	95	-6	-6	✓	0.42	GI028	C-DW06	-
C4-DWLN-27050-08	40	110	140	27	50	95	-6	-6	✓	0.42	GI072	C-DW08-1	AT004
C5-DWLN-35060-08	50	110	165	35	60	95	-6	-6	✓	0.74	GI072	C-DW08-2	AT004
C6-DWLN-45065-08	63	110	190	45	65	95	-6	-6	✓	1.34	GI072	C-DW08-2	AT004
L C4-DWLN-27050-06	40	60	140	27	50	95	-6	-6	✓	0.43	GI028	C-DW06	-
C4-DWLN-27050-08	40	110	140	27	50	95	-6	-6	✓	0.42	GI072	C-DW08-1	AT004
C5-DWLN-35060-08	50	110	165	35	60	95	-6	-6	✓	0.76	GI072	C-DW08-2	AT004
C6-DWLN-45065-08	63	110	190	45	65	95	-6	-6	✓	1.34	GI072	C-DW08-2	AT004



GI028
GI072



WN.. 0604..
WN.. 0804..



C-DW06
C-DW08-1
C-DW08-2



DCS 09
DCS 12
DCS 12



1.7
3.9
3.9



DWS 328-01
DWS 331-12
DWS 331-12



US 2004-T09P
US 2002-T15P
US 2002-T15P



FLAG T09P
FLAG T15P/3,5
FLAG T15P/3,5



CN 034-01
CN 034-01
CN 045-01



AT004a
AT004b



CER WN.N 0804..
CER WN.A 0804..



DCS 12C4
DCS 12C2



**RAILWAY – MILLING
ASSORTMENT**

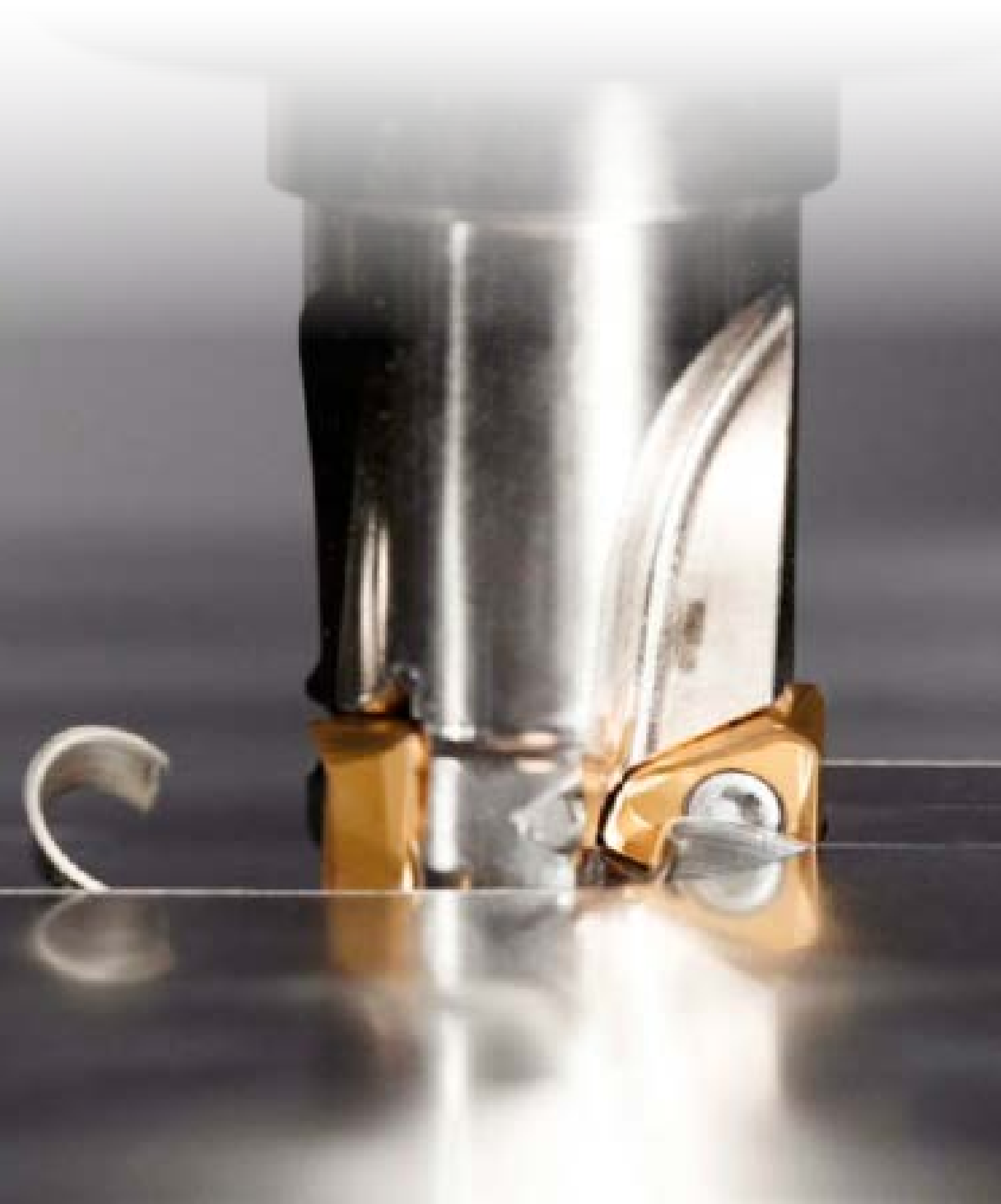

**CONTENT**

7		INTRODUCTION & ASSORTMENT HIGHLIGHTS
13	RAILWAY INDUSTRY	PRODUCTION OF NEW RAILWAY WHEELS
20		RAILWAY WHEEL RECONDITIONING
26		AXLES MACHINING
30		STATIONARY & DYNAMIC RAIL MILLING
37		TURNOUTS MACHINING
57		BASE PLATES MACHINING
63		WAGON & BOGIE PARTS MACHINING
73		TURNING ASSORTMENT
92	POSITIVE INSERTS	
129	NEGATIVE INSERTS	
248	MILLING ASSORTMENT	SOLID HM & HSS MILLS
269		ROTARY BURRS
289		INDEXABLE MILLS
433	HOLEMAKING ASSORTMENT	SOLID CARBIDE & HSS DRILLS
456		REAMERS & COUNTERSINKS
477		EXCHANGEABLE HEAD INDEXABLE DRILLS
533	THEARDING ASSORTMENT	MATERIAL SPECIFIC & HSS TAPS
548		TECHNICAL PART



CUTTING TOOL PARAMETERS ACCORDING TO ISO 13399

All cutting tools are defined by a number of parameters according to the standard ISO 13399. This list contains all the parameters used in this catalogue and their definitions.

ISO 13399 is an international cutting tool information standard. It provides dimensions and parameters in a neutral format that is independent of any particular system or company nomenclature. When cutting tools are clearly defined according to a global standard, all types of software can process the electronic data more quickly, improving the quality of communication and helping to make the exchange of information run smoothly. Supporting a common language in our cutting tool descriptions this will assist system to system communication. It will save you a significant amount of time, providing an easier gathering of high-quality data across our 40,000 solid and indexable tools. By using an ISO 13399 compliant system, there will be no need to manually interpret data and key-enter it into your system.

EXAMPLES ONLY!

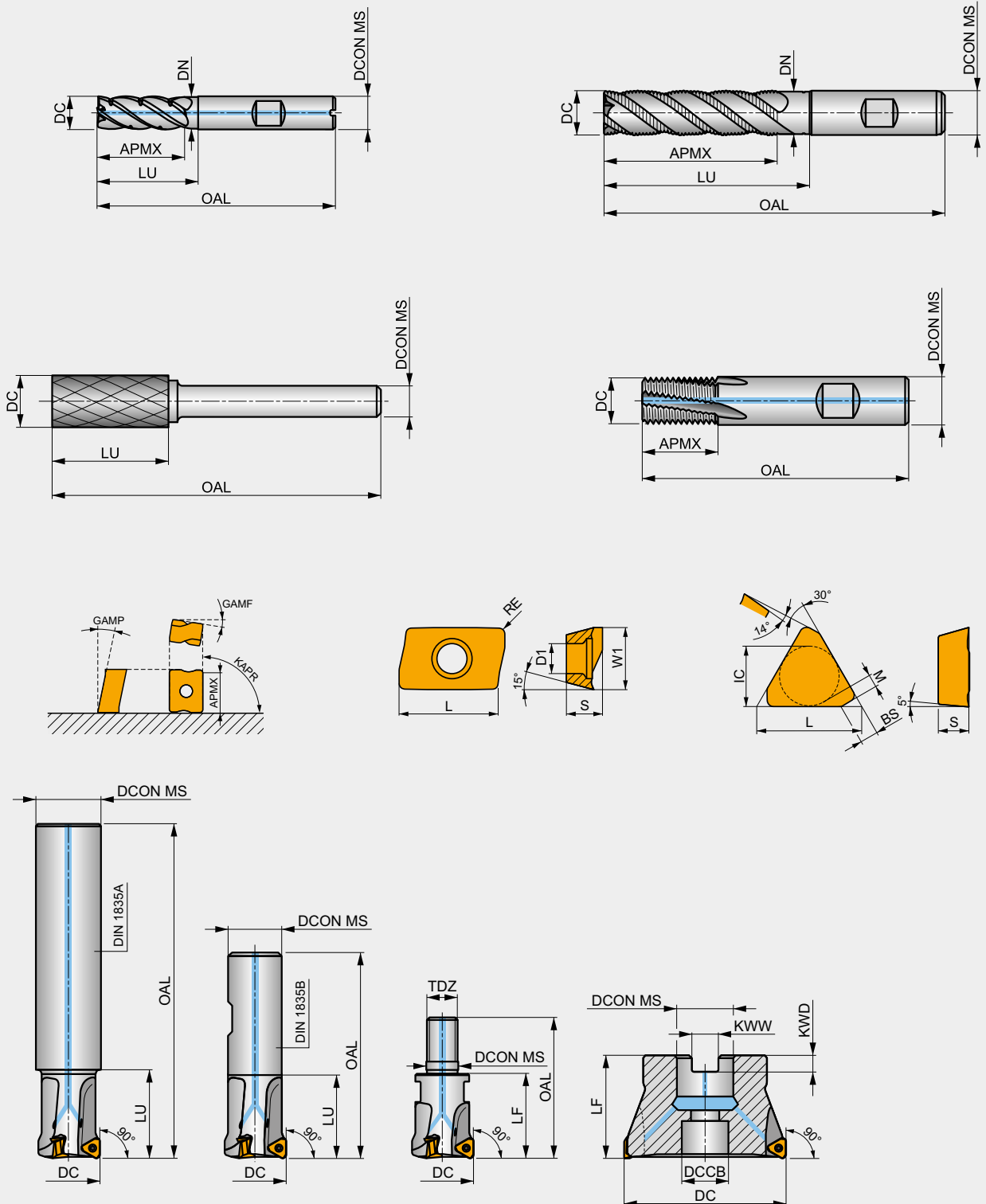



CUTTING TOOL PARAMETERS ACCORDING TO ISO 13399

ISO 13399 code	Description
APMX	Depth of cut maximum
BD	Body diameter
BDX	Body diameter maximum
BCH	Corner chamfer length
BS	Wiper edge length
CBDP	Connection bore depth
CDI	Insert cutting diameter
CDX	Cutting depth maximum
CW	Cutting width
CZC MS	Connection size code machine side
D1	Fixing hole diameter
DAH4	Diameter access hole
DAH5	Diameter access hole
DAH6	Diameter access hole
DBC1	Diameter bolt circle 1
DBC2	Diameter bolt circle 2
DBC4	Diameter bolt circle
DBC5	Diameter bolt circle
DBC6	Diameter bolt circle
DC	Cutting diameter
DCB	Connection bore diameter
DCCB	Counterbore diameter connection bore
DCN	Cutting diameter minimum
DCON MS	Connection diameter
DCX	Cutting diameter maximum
DHUB	Hub diameter
DN	Neck diameter
GAMF	Radial rake angle
GAMP	Axial rake angle

ISO 13399 code	Description
CHW	Corner chamfer width
IC	Inscribed circle diameter
INSD	Insert diameter
INSL	Insert length
KAPR	Tool cutting edge angle
KWD	Keyway depth
KWW	Keyway width
L	Cutting edge length
LB	Body length
LE	Cutting edge effective length
LF	Functional length
LH	Head length
LU	Usable length
LUX	Usable length maximum
M	M-dimension
NOF	Number of flutes
OAL	Overall length
P	Pitch of the blade
PRFA	Profile angle
PRFRAD(2)	Profile radius
RE	Radius
S	Insert thickness
S1	Insert thickness total
TDZ	Thread diameter size
TP	Thread pitch
TPI	Threads per inch
W1	Insert width
ZNP	Number of peripheral edges in the tool



SOLID HM & HSS MILLS



1 **S822**



2 **2-Flute Solid Carbide Slot End Mill**

Medium cut length, 2-flute design provides high rigidity for milling standard slots to a P9 tolerance and ramping operation. AlCrN coating improves performance and extends the tool life.

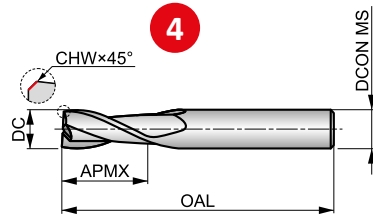

HM	N	NOF 2
	λ 28°	γ 9°
DIN 6535HA	AlCrN	
DORMER		



Workpiece material group suitability, starting values for cutting speed (m/min) and Alpha Code. Tables with feed per tooth and correction factors can be found starting from page 112.

P1.1	P1.2	P1.3	P2.1	P2.2	P2.3	P3.1	P3.2	P3.3	P4.1	P4.2	P4.3	M1.1	M1.2
■ 146 K	■ 164 K	■ 169 K	■ 125 K	■ 110 K	■ 98 J	■ 100 K	■ 82 J	■ 69 J	■ 61 J	■ 52 J	■ 41 J	■ 85 K	■ 72 K
M2.1	M2.2	M3.1	M3.2	M3.3	M4.1	K1.1	K1.2	K1.3	K2.1	K2.2	K2.3	K3.1	K3.2
■ 76 K	■ 62 J	■ 70 J	■ 60 J	■ 54 J	■ 53 J	■ 145 K	■ 108 K	■ 81 K	■ 150 K	■ 122 K	■ 97 J	■ 133 K	■ 102 K
K3.3	K4.1	K4.2	K4.3	K4.4	K4.5	K5.1	K5.2	K5.3	N1.1	N1.2	N1.3	N2.1	N2.2
■ 82 J	■ 123 J	■ 93 J	■ 68 J	■ 59 J	■ 48 J	■ 139 J	■ 105 J	■ 81 J	■ 287 K	■ 216 K	■ 144 K	■ 144 K	■ 129 K
N2.3	N3.1	N3.2	N3.3	N4.1	N4.2	S1.1	S1.2	S2.1	S3.1	S4.1			
■ 93 K	■ 152 K	■ 88 K	■ 45 K	■ 152 K	■ 59 K	■ 58 J	■ 51 J	■ 39 J	■ 29 J	■ 23 J			

DCON MS tolerance h6; DC ≤ 7.00 mm: CHW ±0.03×45° mm; DC > 7.00 mm: CHW ±0.05×45° mm.

Product	DC	CHW	DCON MS	APMX	OAL	NOF
8	(mm)	(mm)	(mm) 9	(mm)	(mm)	
S8222.0	2.00	–	6.00	8.00	57.0	2
S8222.5	2.50	0.08	6.00	12.00	57.0	2

Pos.	Description
1	Designation of solid mills
2	Product description
3	Illustrative picture
4	Schematic drawing of tool
5	Product features

Pos.	Description
6	Milling operations
7	Material group recommendations incl. speed and feed guidance
8	Product code
9	Product dimensions



SOLID HM & HSS MILLS – ICONS OVERVIEW

General icons

	Primary use
	Possible use

Material code (BMC)

HM	Hard Material (Solid Carbide)	HSS-E	High Speed Cobalt Steel Tool Material
HSS-E PM	High Speed Cobalt Powder Metal Tool Material	HSS	High Speed Steel Tool Material

Mill Profile

N	General Purpose Cutter Type for Low to High Resistance Materials	NR	Coarse Pitch Rounded Profile Chipbreaker		Coarse Pitch
W	Non-ferrous Cutter Type for Soft Malleable Materials	HRA	Fine Pitch Asymmetrical Rounded Profile Chipbreaker		Fine Pitch
FS	Semi-finishing Profile Chipbreaker	NRA	Coarse Pitch Asymmetrical Rounded Profile Chipbreaker		
NF	Coarse Pitch Flat Profile Chipbreaker	W NRA	Non-ferrous Cutter Type with Coarse Pitch Asymmetrical Rounded Profile Chipbreaker		

Number of flutes (NOF)

	Number of Flutes = 1 (single tooth)		Number of Flutes = 4 – 5 (teeth)		Number of Flutes = 16 – 24 (teeth)
	Number of Flutes = 2 (teeth)		Number of Flutes = 5 (teeth)		Number of Teeth = 28 – 44 (teeth)
	Number of Flutes = 3 (teeth)		Number of Flutes = 4 – 6 (teeth)		Number of Teeth = 32 – 100 (teeth)
	Number of Flutes = 3 (teeth) differential pitch		Number of Flutes = 4 – 8 (teeth)		Number of Teeth = 48 – 200 (teeth)
	Number of Flutes = 3 – 4 (teeth)		Number of Flutes = 6 – 8 (teeth)		Number of Teeth = 100 – 140 (teeth)
	Number of Flutes = 3 – 5 (teeth)		Number of Flutes = 6 – 12 (teeth)		Number of Teeth = 110 – 180 (teeth)
	Number of Flutes = 3 – 6 (teeth)		Number of Flutes = 8 (teeth)		Number of Teeth = 130 – 220 (teeth)
	Number of Flutes = 4 (teeth)		Number of Flutes = 8 – 12 (teeth)		Number of Teeth = 160 – 350 (teeth)
	Number of Flutes = 4 (teeth) differential pitch		Number of Flutes = 10 – 12 (teeth)		



SOLID HM & HSS MILLS – ICONS OVERVIEW





Cut length





	Cut Length, Extra Short
	Cut Length, Short

	Cut Length, Medium
	Cut Length, Long

	Cut Length, Extra long
---	------------------------







Flute Helix (FHA)







	Unequal (Variable) Helix
	0° Helix Angle (Straight Flute)
	10° Helix Angle (Flute)
	12° Helix Angle (Flute)
	15° Helix Angle (Flute)





	25° Helix Angle (Flute)
	28° Helix Angle (Flute)
	30° Helix Angle (Flute)
	34° Helix Angle (Flute)
	35° Helix Angle (Flute)

	40° Helix Angle (Flute)
	45° Helix Angle (Flute)
	50° Helix Angle (Flute)

Radial rake angle (GAMF)

	-26° Radial Rake Angle (cutting)
	-10° Radial Rake Angle (cutting)
	-6° Radial Rake Angle (cutting)
	0° Radial Rake Angle (Neutral)
	3° Radial Rake Angle (cutting)
	4° Radial Rake Angle (cutting)

	5° Radial Rake Angle (cutting)
	7° Radial Rake Angle (cutting)
	8° Radial Rake Angle (cutting)
	9° Radial Rake Angle (cutting)
	10° Radial Rake Angle (cutting)
	12° Radial Rake Angle (cutting)

	13° Radial Rake Angle (cutting)
	15° Radial Rake Angle (cutting)
	18° Radial Rake Angle (cutting)
	20° Radial Rake Angle (cutting)
	25° Radial Rake Angle (cutting)

Shank

	DIN 1835A Cylindrical Shank
	DIN 1835 – B (Weldon) or D (Threaded) Shank











	DIN 1835D Threaded Shank
	DIN 1835B Weldon Shank

	DIN 6535 HA Cylindrical Shank
	DIN 6535 HB Weldon Shank













SOLID HM & HSS MILLS – ICONS OVERVIEW





Coating

 Alcrona	Aluminium Chromium Nitride Coating	 AlCrN	Aluminium Chromium Nitride Coating	 TiSiN	Titanium Silicon Nitride Coating
 Bright	Bright (uncoated)	 AlTiN	Aluminium Titanium Nitride Coating	 X-CEED	Special AlTiN Coating (with highest oxidation resistance)
 ST	Steam Tempered (Steam Oxide) Surface Treatment	 Hi	Polished Bright Surface Finish	 Diamond	Diamond Like Coating
 TiCN	Titanium Carbonitride Coating	 TiAlN	Titanium Aluminium Nitride Coating		















Cutting Diameter Tolerance Class (TCDC)

 DC d11	d11 – Industry Standard Tool Tolerance Zone (based on diameter range)	 DC h11	h11 – Industry Standard Tool Tolerance Zone (based on diameter range)	 DC k10	k10 – Industry Standard Tool Tolerance Zone (based on diameter range)
 DC e8	e8 – Industry Standard Tool Tolerance Zone (based on diameter range)	 DC h12	h12 – Industry Standard Tool Tolerance Zone (based on diameter range)	 DC k12	k12 – Industry Standard Tool Tolerance Zone (based on diameter range)
 DC h9	h9 – Industry Standard Tool Tolerance Zone (based on diameter range)	 DC js14	js14 – Industry Standard Tool Tolerance Zone (based on diameter range)		
 DC h10	h10 – Industry Standard Tool Tolerance Zone (based on diameter range)	 DC js16	js16 – Industry Standard Tool Tolerance Zone (based on diameter range)		

Cutting Direction

 Radial	 Radial, Diagonal, Axial
 Radial, Diagonal	 Radial

Basic Standard Group (BSG)

 BS 122/4	BS 122/4 – Screwed Shank End Mill Standards	 DIN 1880	DIN 1880 – Shell Mill Standards	 DIN 851	DIN 851 – T-Slot Cutter Standards
 DIN 1833C	DIN 1833 C – Dovetail Cutter Standards	 DIN 327D	DIN 327 D – Slot Drill Standards	 DIN 885A	DIN 885 A – Side & Face Mill Standards
 DIN 1833D	DIN 1833 D – Inverted Dovetail Cutter Standards	 DIN 844K	DIN 844 K – End Mill Standards	 DIN 6527K	DIN 6527 K – Carbide End Mill Standards
 DIN 1837	DIN 1837 – Fine Slitting Saw Standards	 DIN 844L	DIN 844 L – HSS End Mills Standards	 DIN 6527L	DIN 6527 L – Carbide End Mill Standards
 DIN 1838	DIN 1838 – Coarse Slitting Saw Standards	 DIN 850	DIN 850 – Keyseat Cutter Standards	 DORMER	DORMER Standards



SOLID HM & HSS MILLS – ICONS OVERVIEW

Cooling (CSP)



Through Tool Coolant

Operations Milling

	Deep Shoulder Milling		Progressive Plunging		T-Slot Milling
	Deep Slot Milling		Drilling		Dovetail Milling
	Shallow Slot Milling		Helical Interpolation		Inverse Dovetail Milling
	Shallow Shoulder Milling		Turn Milling		Woodruff Slot Milling
	P9 Slotting (Keyway)		Contoured Surfaces (Copy Milling)		Milling – Tube Sawing
	Ramping		Face Milling		Milling – Cut-off Sawing
	Plunge Milling		Chamfer Milling		
	Trochoidal Milling		Rear Face Milling		

SOLID HM MILLS – FAMILIES

With our assortment of Solid HM Mills we can offer solutions to machine material for practically any WMG.

Our Solid HM Mills families:

Line	Description
S7xx	With rake angle value from 7° to 10° offers a wide usage in medium strength steel and cast steels, medium strength stainless steels, cast irons and medium strength high temperature alloys.
S8xx S501 S511	Rake angle 10° suit for a multiapplication usage in mild up to medium strength steel and cast steels, mild to medium strength stainless steels, cast irons and non-ferrous materials such as aluminium and copper and its alloys.
S9xx	Rake angle 12° makes the cutter ideal for general purposes use for softer materials, such as free machining up to medium strength steel and cast steels, cast irons, non-ferrous materials and pure titanium.



Material code (BMC)	HM	HM	HM	HM	HSS-E	HSS-E	HSS-E						
Mill Profile	N	N	N	N	N	N	N						
Number of flutes (NOF)	NOF 2	NOF 2	NOF 2	NOF 2	NOF 2	NOF 8-12	NOF 4-6						
Cut length													
Flute Helix (FHA)	λ 40°	λ 28°	λ 28°	λ 30°	λ 30°	λ 15°	λ 0°						
Radial rake angle (GAMF)	γ 10°	γ 9°	γ 9°	γ 12°	γ 12°	γ 15°	γ 0°						
Shank	 DIN 6535HA	 DIN 6535HA	 DIN 6535HA	 DIN 6535HB	 DIN 1835B	 DIN 1835B	 DIN 1835B						
Coating	 AlCN	 AlCN	 AlCN	 TiAlN	 Bright	 Bright	 Bright						
Cutting diameter tolerance class (TCDC)	DC h9			DC h10	DC e8	DC js16							
Direction													
Basic standard group (BSG)	 DORMER	 DIN 6527L	 DORMER	 DORMER	 DORMER	 DORMER	 DORMER						
Cooling (CSP)													
Product Family Code	 S710	 S812HA	 S822	 S922	 C135	 C825	 C700						
	1.00 - 20.00	2.00 - 20.00	2.00 - 20.00	2.00 - 20.00	2.00 - 20.00	40.00 - 63.00	1.00 - 20.00						
	 255	 256	 257	 258	 259	 260	 261						
P	P1	■	■	■	■	■	■						
	P2	■	■	■	■	▣	■						
	P3	■	■	■	■	▣	■						
	P4	■	■	■	■	▣	■						
M	M1	■	■	■	■	▣	■						
	M2	■	■	■	■	▣	■						
	M3	■	■	■	■	▣	■						
	M4	■	■	■	■	▣	■						
K	K1	■	■	■	■	▣	■						
	K2	■	■	■	■	▣	■						
	K3	■	■	■	■	▣	■						
	K4	■	■	■	■	▣	■						
	K5	■	■	■	■	▣	■						
N	N1	■	■	■	▣	▣	■						
	N2	■	■	■	■	▣	■						
	N3	■	■	■	■	▣	■						
	N4	■	▣	▣	▣	▣	■						
	N5	■	■	■	■	▣	■						
S	S1	■	■	■	▣	▣	■						
	S2	■	■	■	■	▣	■						
	S3	■	■	■	■	▣	■						
	S4	■	■	■	■	▣	■						
H	H1												
	H2												
	H3												
	H4												

■ Primary use ▣ Possible use



S710



2-Flute Solid Carbide End Mill

Short cut length, 2-flute design with 40° helix provides high rigidity for milling standard slots. AlCrN coating improves performance and extends the tool life.

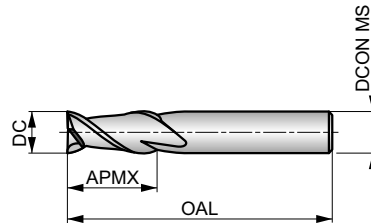

HM	N	NOF 2
	λ 40°	γ 10°
DIN 6535HA	AlCrN	DC h9
	DORMER	



Workpiece material group suitability, starting values for cutting speed (m/min) and Alpha Code. Tables with feed per tooth and correction factors can be found starting from page XY.

P1.1 ■ 199 K	P1.2 ■ 223 K	P1.3 ■ 230 K	P2.1 ■ 170 K	P2.2 ■ 150 K	P2.3 ■ 133 J	P3.1 ■ 138 K	P3.2 ■ 111 J	P3.3 ■ 94 J	P4.1 ■ 82 J	P4.2 ■ 70 J	M1.1 ■ 115 K	M1.2 ■ 97 K	M2.1 ■ 102 K
M2.2 ■ 84 J	M3.1 ■ 94 J	M3.2 ■ 81 J	K1.1 ■ 196 K	K1.2 ■ 145 K	K1.3 ■ 109 K	K2.1 ■ 202 K	K2.2 ■ 164 K	K2.3 ■ 131 J	K3.1 ■ 178 K	K3.2 ■ 136 K	K3.3 ■ 110 J	K4.1 ■ 165 J	K4.2 ■ 125 J
K4.3 ■ 91 J	K4.4 ■ 78 J	K4.5 ■ 65 J	K5.1 ■ 187 J	K5.2 ■ 141 J	K5.3 ■ 109 J	S1.2 ■ 69 J	S2.1 ■ 53 J	S3.1 ■ 40 J	S4.1 ■ 31 J				

DCON MS tolerance h6.

Product	DC (mm)	DCON MS (mm)	APMX (mm)	OAL (mm)	NOF
S7101.0	1.00	3.00	3.00	40.0	2
S7101.5	1.50	3.00	4.50	40.0	2
S7102.0	2.00	3.00	6.50	40.0	2
S7102.5	2.50	3.00	6.50	40.0	2
S7103.0	3.00	6.00	9.00	50.0	2
S7104.0	4.00	6.00	12.00	50.0	2
S7105.0	5.00	6.00	15.00	50.0	2
S7106.0	6.00	6.00	20.00	60.0	2
S7108.0	8.00	8.00	20.00	64.0	2
S71010.0	10.00	10.00	22.00	75.0	2
S71012.0	12.00	12.00	25.00	75.0	2
S71016.0	16.00	16.00	32.00	90.0	2
S71020.0	20.00	20.00	38.00	100.0	2



S812HA



2-Flute Solid Carbide Slot End Mill, DIN 6535 HA Shank

Short cut length, 2-flute design provides high rigidity for milling standard slots to a P9 tolerance and ramping operation. AlCrN coating improves performance and extends the tool life.

HM	N	NOF 2
	λ 28°	γ 9°
DIN 6535HA	AlCrN	
DIN 6527L		

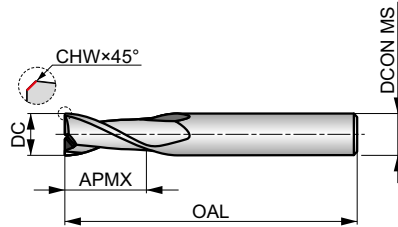

Workpiece material group suitability, starting values for cutting speed (m/min) and Alpha Code. Tables with feed per tooth and correction factors can be found starting from page XY.

P1.1 ■ 166 K	P1.2 ■ 186 K	P1.3 ■ 192 K	P2.1 ■ 142 K	P2.2 ■ 125 K	P2.3 ■ 111 J	P3.1 ■ 115 K	P3.2 ■ 93 J	P3.3 ■ 78 J	P4.1 ■ 68 J	P4.2 ■ 59 J	P4.3 ■ 47 J	M1.1 ■ 97 K	M1.2 ■ 81 K
M2.1 ■ 85 K	M2.2 ■ 71 J	M3.1 ■ 79 J	M3.2 ■ 68 J	M3.3 ■ 61 J	M4.1 ■ 60 J	K1.1 ■ 166 K	K1.2 ■ 123 K	K1.3 ■ 92 K	K2.1 ■ 170 K	K2.2 ■ 138 K	K2.3 ■ 110 J	K3.1 ■ 150 K	K3.2 ■ 115 K
K3.3 ■ 93 J	K4.1 ■ 140 J	K4.2 ■ 105 J	K4.3 ■ 77 J	K4.4 ■ 66 J	K4.5 ■ 56 J	K5.1 ■ 159 J	K5.2 ■ 118 J	K5.3 ■ 92 J	N1.1 ■ 330 K	N1.2 ■ 247 K	N1.3 ■ 166 K	N2.1 ■ 166 K	N2.2 ■ 148 K
N2.3 ■ 107 K	N3.1 ■ 173 K	N3.2 ■ 101 K	N3.3 ■ 52 K	N4.1 ■ 173 K	N4.2 ■ 67 K	S1.1 ■ 72 J	S1.2 ■ 64 J	S2.1 ■ 49 J	S3.1 ■ 38 J	S4.1 ■ 30 J			

DCON MS tolerance h6; DC ≤ 7.00 mm: CHW ± 0.03X45° mm; DC > 7.00 mm: CHW ± 0.05X45° mm.

Product	DC (mm)	CHW (mm)	DCON MS (mm)	APMX (mm)	OAL (mm)	NOF
S812HA2.0	2.00	—	6.00	6.00	57.0	2
S812HA2.5	2.50	0.08	6.00	7.00	57.0	2
S812HA3.0	3.00	0.08	6.00	7.00	57.0	2
S812HA3.5	3.50	0.08	6.00	7.00	57.0	2
S812HA4.0	4.00	0.13	6.00	8.00	57.0	2
S812HA4.5	4.50	0.13	6.00	8.00	57.0	2
S812HA5.0	5.00	0.13	6.00	10.00	57.0	2
S812HA6.0	6.00	0.13	6.00	10.00	57.0	2
S812HA7.0	7.00	0.13	8.00	13.00	63.0	2
S812HA8.0	8.00	0.20	8.00	16.00	63.0	2
S812HA9.0	9.00	0.20	10.00	16.00	72.0	2
S812HA10.0	10.00	0.20	10.00	19.00	72.0	2
S812HA12.0	12.00	0.20	12.00	22.00	83.0	2
S812HA14.0	14.00	0.20	14.00	22.00	83.0	2
S812HA16.0	16.00	0.20	16.00	26.00	92.0	2
S812HA18.0	18.00	0.20	18.00	26.00	92.0	2
S812HA20.0	20.00	0.30	20.00	32.00	104.0	2



S822



2-Flute Solid Carbide Slot End Mill

Medium cut length, 2-flute design provides high rigidity for milling standard slots to a P9 tolerance and ramping operation. AlCrN coating improves performance and extends the tool life.

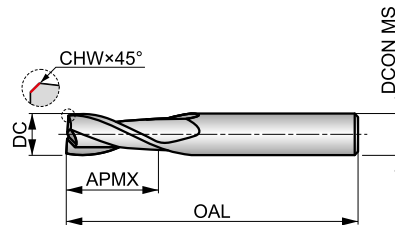

HM	N	NOF 2
	λ 28°	γ 9°
DIN 6535HA	AlCrN	
DORMER		



Workpiece material group suitability, starting values for cutting speed (m/min) and Alpha Code. Tables with feed per tooth and correction factors can be found starting from page XY.

P1.1 ■ 146 K	P1.2 ■ 164 K	P1.3 ■ 169 K	P2.1 ■ 125 K	P2.2 ■ 110 K	P2.3 ■ 98 J	P3.1 ■ 101 K	P3.2 ■ 82 J	P3.3 ■ 69 J	P4.1 ■ 61 J	P4.2 ■ 52 J	P4.3 ■ 41 J	M1.1 ■ 85 K	M1.2 ■ 72 K
M2.1 ■ 76 K	M2.2 ■ 62 J	M3.1 ■ 70 J	M3.2 ■ 60 J	M3.3 ■ 54 J	M4.1 ■ 53 J	K1.1 ■ 145 K	K1.2 ■ 108 K	K1.3 ■ 81 K	K2.1 ■ 150 K	K2.2 ■ 122 K	K2.3 ■ 97 J	K3.1 ■ 133 K	K3.2 ■ 102 K
K3.3 ■ 82 J	K4.1 ■ 123 J	K4.2 ■ 93 J	K4.3 ■ 68 J	K4.4 ■ 59 J	K4.5 ■ 48 J	K5.1 ■ 139 J	K5.2 ■ 105 J	K5.3 ■ 81 J	N1.1 ■ 287 K	N1.2 ■ 216 K	N1.3 ■ 144 K	N2.1 ■ 144 K	N2.2 ■ 129 K
N2.3 ■ 93 K	N3.1 ■ 152 K	N3.2 ■ 88 K	N3.3 ■ 45 K	N4.1 ■ 152 K	N4.2 ■ 59 K	S1.1 ■ 58 J	S1.2 ■ 51 J	S2.1 ■ 39 J	S3.1 ■ 29 J	S4.1 ■ 23 J			

DCON MS tolerance h6; DC≤7.00 mm: CHW ± 0.03X45° mm; DC>7.00 mm: CHW ± 0.05X45° mm.

Product	DC (mm)	CHW (mm)	DCON MS (mm)	APMX (mm)	OAL (mm)	NOF
S8222.0	2.00	—	6.00	8.00	57.0	2
S8222.5	2.50	0.08	6.00	12.00	57.0	2
S8223.0	3.00	0.08	6.00	12.00	57.0	2
S8224.0	4.00	0.13	6.00	14.00	57.0	2
S8225.0	5.00	0.13	6.00	16.00	57.0	2
S8226.0	6.00	0.13	6.00	19.00	57.0	2
S8227.0	7.00	0.13	8.00	19.00	63.0	2
S8228.0	8.00	0.20	8.00	19.00	63.0	2
S8229.0	9.00	0.20	10.00	21.00	72.0	2
S82210.0	10.00	0.20	10.00	22.00	72.0	2
S82212.0	12.00	0.20	12.00	25.00	83.0	2
S82214.0	14.00	0.20	14.00	30.00	83.0	2
S82216.0	16.00	0.20	16.00	32.00	92.0	2
S82218.0	18.00	0.20	18.00	32.00	92.0	2
S82220.0	20.00	0.30	20.00	38.00	104.0	2



S922



2-Flute Solid Carbide End Mill

Medium cut length, 2-flute design with 30° helix provides high rigidity for milling standard slots. Cylindrical shank for cutting diameter up to 5 mm. TiALN coating for higher temperature resistance and longer tool life.

HM	N	NOF 2
	λ 30°	γ 12°
DIN 6535HB	TiALN	DC h10
	DORMER	

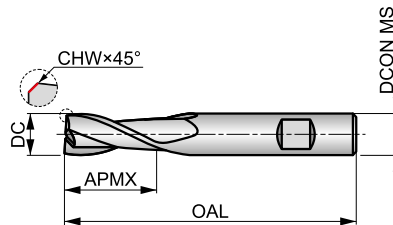

Workpiece material group suitability, starting values for cutting speed (m/min) and Alpha Code. Tables with feed per tooth and correction factors can be found starting from page XY.

P1.1 ■ 132 K	P1.2 ■ 148 K	P1.3 ■ 153 K	P2.1 ■ 113 K	P2.2 ■ 100 K	P2.3 ■ 88 J	P3.1 ■ 98 K	P3.2 ■ 79 J	P3.3 ■ 67 J	P4.1 ■ 59 J	P4.2 ■ 50 J	P4.3 ■ 41 J	K1.1 ■ 100 K	K1.2 ■ 74 K
K1.3 ■ 56 K	K2.1 ■ 107 K	K2.2 ■ 87 K	K2.3 ■ 70 J	K3.1 ■ 95 K	K3.2 ■ 72 K	K3.3 ■ 59 J	K4.1 ■ 88 J	K4.2 ■ 67 J	K4.3 ■ 49 J	K4.4 ■ 42 J	K4.5 ■ 35 J	K5.1 ■ 100 J	K5.2 ■ 75 J
K5.3 ■ 58 J	N1.1 ■ 296 K	N1.2 ■ 222 K	N1.3 ■ 149 K	N2.1 ■ 149 K	N2.2 ■ 133 K	N2.3 ■ 96 K	N3.1 ■ 156 K	N3.2 ■ 91 K	N3.3 ■ 47 K	N4.1 ■ 156 K	N4.2 ■ 60 K	N4.3 ■ 64 K	S1.1 ■ 47 J
S1.2 ■ 45 J	S1.3 ■ 20 J												

DCON MS tolerance h6; DC ≤ 10.00 mm: CHW ± 0.03X45° mm; DC > 10.00 mm: CHW ± 0.05X45° mm.
Products from this series are also available in set. Please see S991.

Product	DC (mm)	CHW (mm)	DCON MS (mm)	APMX (mm)	OAL (mm)	NOF
S9222.0 ¹⁾	2.00	0.08	3.00	6.00	38.0	2
S9222.5 ¹⁾	2.50	0.08	3.00	9.00	38.0	2
S9223.0 ¹⁾	3.00	0.08	3.00	12.00	38.0	2
S9224.0 ¹⁾	4.00	0.08	4.00	14.00	50.0	2
S9225.0 ¹⁾	5.00	0.13	5.00	16.00	50.0	2
S9226.0	6.00	0.13	6.00	19.00	57.0	2
S9227.0	7.00	0.13	8.00	19.00	63.0	2
S9228.0	8.00	0.13	8.00	19.00	63.0	2
S9229.0	9.00	0.13	10.00	21.00	72.0	2
S92210.0	10.00	0.18	10.00	22.00	72.0	2
S92212.0	12.00	0.20	12.00	25.00	73.0	2
S92214.0	14.00	0.20	14.00	30.00	83.0	2
S92216.0	16.00	0.20	16.00	32.00	92.0	2
S92218.0	18.00	0.20	18.00	32.00	92.0	2
S92220.0	20.00	0.30	20.00	38.00	104.0	2

¹⁾ Cylindrical shank.



C135



2-Flute HSS-E Extra Long Reach Slot End Mill, Bright Finish

Short cut length, 2-flute design provides high rigidity for milling standard keyway slots to a P9 tolerance. Provides increased strength and reduced vibrations in difficult to reach areas. This can be used in mild steels and non-ferrous materials.

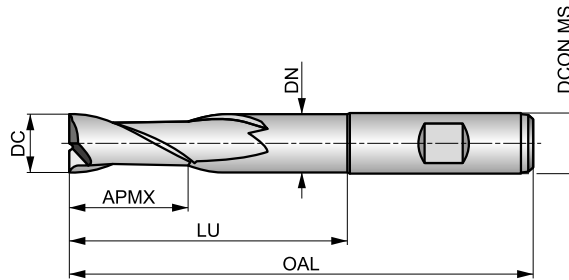

HSS-E	N	NOF 2
	λ 30°	γ 12°
DIN 1835B	Bright	DC e8



Workpiece material group suitability, starting values for cutting speed (m/min) and Alpha Code. Tables with feed per tooth and correction factors can be found starting from page XY.

P1.1 ■ 46 C	P1.2 ■ 52 C	P1.3 ■ 54 C	P2.1 ■ 40 C	P2.2 ■ 35 C	P3.1 ■ 32 C	P3.2 ■ 26 B	P4.1 ■ 19 B	M1.1 ■ 34 C	M1.2 ■ 29 C	M2.1 ■ 31 C	M2.2 ■ 25 B	K1.1 ■ 30 C	K1.2 ■ 22 C
K1.3 ■ 17 C	K2.1 ■ 49 C	K2.2 ■ 40 C	K2.3 ■ 32 B	K3.1 ■ 44 C	K3.2 ■ 33 C	K3.3 ■ 27 A	K4.1 ■ 40 B	K4.2 ■ 30 B	K4.3 ■ 22 B	K4.4 ■ 19 A	K4.5 ■ 16 A	K5.1 ■ 46 B	K5.2 ■ 34 B
K5.3 ■ 27 B	N1.1 ■ 81 E	N1.2 ■ 60 D	N1.3 ■ 41 D	N2.1 ■ 41 C	N2.2 ■ 37 C	N2.3 ■ 26 C	N3.1 ■ 43 C	N3.2 ■ 25 C	N3.3 ■ 13 C	N4.1 ■ 43 C	S1.1 ■ 30 B	S1.2 ■ 25 B	S2.1 ■ 20 A
S3.1 ■ 15 A	S4.1 ■ 12 A												

DCON MS tolerance h6.

Product	DC (mm)	DCON MS (mm)	APMX (mm)	OAL (mm)	NOF	LU (mm)	DN (mm)
C1352.0	2.00	6.00	7.00	54.0	2	18.00	1.80
C1353.0	3.00	6.00	8.00	56.0	2	20.00	2.80
C1354.0	4.00	6.00	11.00	63.0	2	27.00	3.70
C1355.0	5.00	6.00	13.00	68.0	2	32.00	4.70
C1356.0	6.00	6.00	13.00	68.0	2	32.00	5.70
C1358.0	8.00	10.00	19.00	88.0	2	48.00	7.50
C13510.0	10.00	10.00	22.00	95.0	2	54.50	9.50
C13512.0	12.00	12.00	26.00	110.0	2	64.50	11.50
C13514.0	14.00	12.00	26.00	110.0	2	64.50	11.50
C13516.0	16.00	16.00	32.00	123.0	2	74.50	15.50
C13518.0	18.00	16.00	32.00	123.0	2	74.50	15.50
C13520.0	20.00	20.00	38.00	141.0	2	90.50	19.50



C825



HSS-E Side and Face Cutter

Versatile side and face cutters for grooving and slot milling. The Weldon shank provides accurate and stable holding whilst the side and face milling head makes the tools good for creating slots in vertical walls. The bright finish prevents workpiece material from sticking to the cutting edges of the tool.

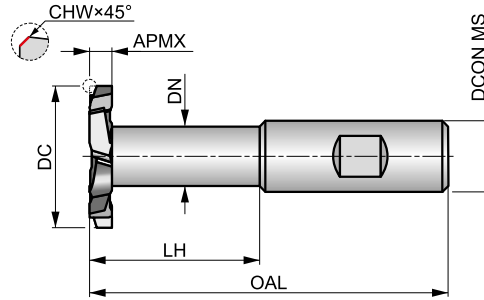

HSS-E	N	NOF 8-12
λ 15°	γ 15°	DIN 1835B
Bright	DC js16	
DORMER		

Workpiece material group suitability, starting values for cutting speed (m/min) and Alpha Code. Tables with feed per tooth and correction factors can be found starting from page XY.

P1.1 ■ 40V	P1.2 ■ 45V	P1.3 ■ 46V	P2.1 ■ 34V	P2.2 ■ 30U	P2.3 ■ 27T	P3.1 ■ 22U	P3.2 ■ 18U	P3.3 ■ 15T	P4.1 ■ 13U	P4.2 ■ 11T	P4.3 ■ 9T	M1.1 ■ 21S	M1.2 ■ 17S
M2.1 ■ 18S	M2.2 ■ 15S	M3.1 ■ 12S	M3.2 ■ 10S	M3.3 ■ 9S	M4.1 ■ 10S	K1.1 ■ 25V	K1.2 ■ 19V	K1.3 ■ 14V	K2.1 ■ 37U	K2.2 ■ 30U	K2.3 ■ 24U	K3.1 ■ 33U	K3.2 ■ 25U
K3.3 ■ 20U	K4.1 ■ 30S	K4.2 ■ 23S	K4.3 ■ 17S	K4.4 ■ 14S	K4.5 ■ 12S	K5.1 ■ 34U	K5.2 ■ 26U	K5.3 ■ 20U	N1.1 ■ 71Y	N1.2 ■ 53Y	N1.3 ■ 36Y	N2.1 ■ 36Y	N2.2 ■ 32Y
N2.3 ■ 23Y	N3.1 ■ 38V	N3.2 ■ 22V	N3.3 ■ 11W	N4.1 ■ 38Y	S1.1 ■ 35V	S1.2 ■ 20V	S1.3 ■ 10U	S2.1 ■ 7U	S2.2 ■ 7T	S3.1 ■ 5U	S3.2 ■ 5T	S4.1 ■ 4U	S4.2 ■ 4T

DCON MS tolerance h6.

Product	APMX	DC	CHW	DN	LH	OAL	DCON MS	NOF
	(mm)	(mm)	(mm)	(mm)	(mm)	(mm)	(mm)	
C8253.0X40.0	3.00	40.00	0.15	19.20	49.0	100.0	20.00	8
C8254.0X40.0	4.00	40.00	0.15	19.20	49.0	100.0	20.00	8
C8255.0X40.0	5.00	40.00	0.15	19.20	49.0	100.0	20.00	8
C8256.0X40.0	6.00	40.00	0.15	19.20	49.0	100.0	20.00	8
C8258.0X40.0	8.00	40.00	0.15	19.20	49.0	100.0	20.00	8
C82510.0X40.0	10.00	40.00	0.15	19.20	49.0	100.0	20.00	8
C8256.0X63.0	6.00	63.00	0.15	24.20	73.0	130.0	25.00	12
C8258.0X63.0	8.00	63.00	0.15	24.20	73.0	130.0	25.00	12
C82510.0X63.0	10.00	63.00	0.15	24.20	73.0	130.0	25.00	12
C82512.0X63.0	12.00	63.00	0.15	24.20	73.0	130.0	25.00	12
C82514.0X63.0	14.00	63.00	0.15	24.20	73.0	130.0	25.00	12
C82516.0X63.0	16.00	63.00	0.15	24.20	73.0	130.0	25.00	12



C700



HSS-E Corner Rounding Cutter

With an accurate ground radius, suitable for producing accurate corner radii around the perimeter of components. The Weldon shank ensures stable holding to improve radius surface finish. Suitable for corner radius milling. Bright finish.

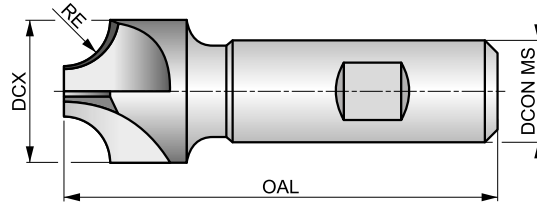

HSS-E	N	NOF 4-6
	λ 0°	γ 0°
DIN 1835B	Bright	
DORMER		



Workpiece material group suitability, starting values for cutting speed (m/min) and Alpha Code. Tables with feed per tooth and correction factors can be found starting from page XY.

P1.1 ■ 33 W	P1.2 ■ 37 W	P1.3 ■ 38 W	P2.1 ■ 28 W	P2.2 ■ 25 W	P2.3 ■ 22 W	P3.1 ■ 22 W	P3.2 ■ 18 W	P3.3 ■ 15 W	P4.1 ■ 13 W	P4.2 ■ 11 W	P4.3 ■ 9 W	M1.1 ■ 27 U	M1.2 ■ 23 U
M2.1 ■ 24 U	M2.2 ■ 20 U	M3.1 ■ 17 U	M3.2 ■ 15 U	M3.3 ■ 14 U	M4.1 ■ 10 U	K1.1 ■ 20 W	K1.2 ■ 15 W	K1.3 ■ 11 W	K2.1 ■ 31 W	K2.2 ■ 25 W	K2.3 ■ 20 W	K3.1 ■ 27 W	K3.2 ■ 21 W
K3.3 ■ 17 W	K4.1 ■ 25 U	K4.2 ■ 19 U	K4.3 ■ 14 U	K4.4 ■ 12 U	K4.5 ■ 10 U	K5.1 ■ 29 W	K5.2 ■ 21 W	K5.3 ■ 17 W	N1.1 ■ 57 X	N1.2 ■ 43 X	N1.3 ■ 29 X	N2.1 ■ 29 X	N2.2 ■ 26 X
N2.3 ■ 19 X	N3.1 ■ 30 X	N3.2 ■ 17 X	N3.3 ■ 9 X	S1.1 ■ 25 U	S1.2 ■ 20 U	S1.3 ■ 10 U	S2.1 ■ 13 U	S2.2 ■ 7 U	S3.1 ■ 10 U	S3.2 ■ 5 U	S4.1 ■ 8 U	S4.2 ■ 4 U	

DCON MS tolerance h6.

Product	RE (mm)	DCX (mm)	DCON MS (mm)	OAL (mm)	NOF
C7001.0	1.00	10.00	10.00	60.0	4
C7001.5	1.50	10.00	10.00	60.0	4
C7002.0	2.00	10.00	10.00	60.0	4
C7002.5	2.50	10.00	10.00	60.0	4
C7003.0	3.00	12.00	12.00	60.0	4
C7003.5	3.50	12.00	12.00	60.0	4
C7004.0	4.00	15.00	12.00	60.0	4
C7005.0	5.00	18.00	16.00	70.0	4
C7006.0	6.00	21.00	16.00	70.0	4
C7007.0	7.00	24.00	16.00	70.0	4
C7008.0	8.00	24.00	16.00	70.0	4
C7009.0	9.00	28.00	20.00	85.0	4
C70010.0	10.00	28.00	20.00	85.0	4
C70012.0	12.00	35.00	20.00	100.0	4
C70012.5	12.50	35.00	20.00	100.0	4
C70014.0	14.00	42.00	25.00	100.0	4
C70015.0	15.00	48.00	25.00	105.0	5
C70016.0	16.00	48.00	25.00	105.0	5
C70020.0	20.00	60.00	32.00	115.0	6



SOLID HM MILLS – FEED PER TOOTH TABLE

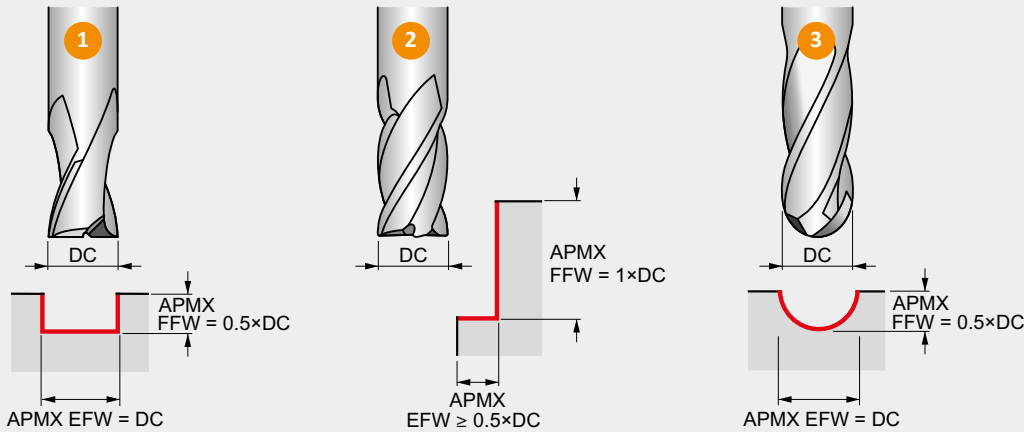

Feed per tooth f_z (mm/rev) depending on the working conditions it might be necessary to adjust these values $\pm 25\%$.

ONLY if plunging into solid material with a centre cutting end mill the values in this table should be considered as f_r (feed per revolution).

How to use this table to find the feed per tooth f_z :

1. Find your Alpha Code on the product page (example: 199K, "K" is the Alpha Code).
2. Find the closest diameter for your cutting application in the top row of the table.
3. Find your Alpha Code in the left column of the table.
4. The intersection (cell) of the Diameter and Alpha Code is the feed per tooth f_z .

**FOR SOLID
CARBIDE
MILLING
CUTTERS ONLY**

		\varnothing DC (mm)																
		1.00	2.00	3.00	4.00	5.00	6.00	7.00	8.00	9.00	10.00	12.00	14.00	16.00	18.00	20.00	22.00	25.00
Feed rates	A	0.002	0.003	0.004	0.005	0.006	0.007	0.008	0.009	0.010	0.011	0.014	0.015	0.017	0.019	0.021	0.025	0.028
	B	0.002	0.003	0.004	0.005	0.006	0.007	0.008	0.009	0.010	0.011	0.014	0.015	0.017	0.019	0.021	0.025	0.028
	C	0.002	0.003	0.004	0.005	0.006	0.007	0.008	0.009	0.010	0.011	0.014	0.015	0.017	0.019	0.021	0.025	0.028
	D	0.002	0.003	0.004	0.005	0.007	0.008	0.009	0.010	0.011	0.012	0.014	0.015	0.017	0.019	0.021	0.025	0.028
	E	0.002	0.003	0.004	0.008	0.009	0.012	0.013	0.014	0.015	0.016	0.019	0.021	0.024	0.026	0.028	0.030	0.034
	F	0.002	0.003	0.006	0.010	0.013	0.016	0.017	0.019	0.021	0.022	0.026	0.029	0.032	0.035	0.039	0.042	0.047
	G	0.002	0.005	0.008	0.014	0.018	0.022	0.024	0.026	0.028	0.031	0.035	0.040	0.044	0.048	0.053	0.057	0.064
	I	0.003	0.006	0.011	0.019	0.024	0.030	0.032	0.036	0.039	0.042	0.049	0.054	0.061	0.066	0.073	0.079	0.088
	J	0.004	0.009	0.014	0.026	0.033	0.041	0.044	0.048	0.053	0.057	0.066	0.074	0.083	0.090	0.099	0.107	0.120
	K	0.006	0.012	0.019	0.035	0.044	0.054	0.059	0.064	0.070	0.076	0.088	0.098	0.110	0.120	0.132	0.142	0.160
	N	0.008	0.016	0.025	0.047	0.058	0.072	0.078	0.086	0.094	0.101	0.117	0.131	0.146	0.160	0.175	0.189	0.212
	O	0.010	0.021	0.034	0.062	0.078	0.096	0.104	0.114	0.124	0.135	0.156	0.174	0.195	0.213	0.233	0.252	0.283
	P	0.014	0.028	0.045	0.083	0.104	0.128	0.138	0.152	0.166	0.180	0.207	0.231	0.259	0.283	0.311	0.335	0.376
	R	0.018	0.037	0.060	0.110	0.138	0.170	0.184	0.202	0.221	0.239	0.276	0.308	0.345	0.377	0.414	0.446	0.501
	S	0.024	0.049	0.080	0.147	0.183	0.226	0.245	0.269	0.294	0.318	0.367	0.410	0.459	0.502	0.550	0.593	0.667



SOLID HM MILLS – FEED PER TOOTH TABLE

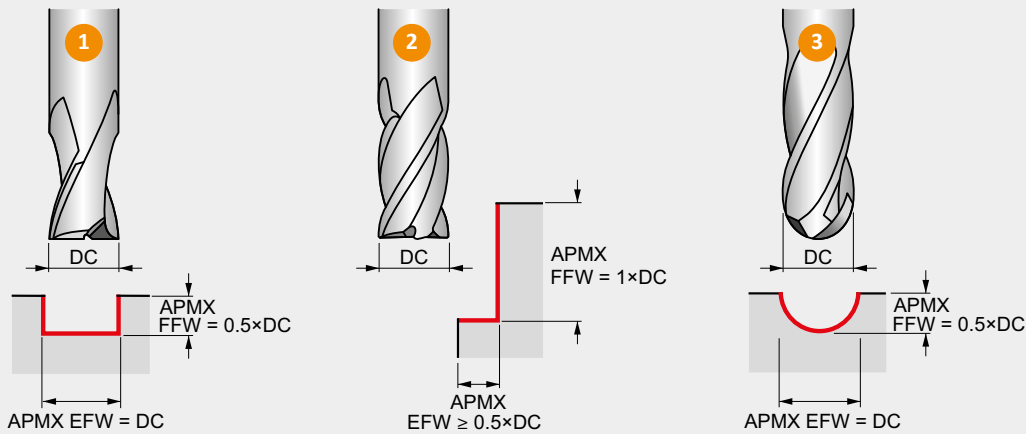

Feed per tooth *IPT* or (inch/tooth) depending on the working conditions it might be necessary to adjust these values $\pm 25\%$.

ONLY if plunging into solid material with a centre cutting end mill the values in this table should be considered as *IPR* (feed in inch per revolution).

How to use this table to find the feed per tooth *IPT*:

1. Find your Alpha Code on the product page (example: 653K, "K" is the Alpha Code).
2. Find the closest diameter for your cutting application in the top row of the table.
3. Find your Alpha Code in the left column of the table.
4. The intersection (cell) of the Diameter and Alpha Code is the feed per tooth *IPT*.

**FOR SOLID
CARBIDE
MILLING
CUTTERS ONLY**

		ϕ DC (inch)															
		1/16	3/32	1/8	5/32	3/16	7/32	1/4	5/16	3/8	7/16	1/2	9/16	5/8	3/4	7/8	1
		.0625	.0938	.1250	.1563	.1875	.2188	.2500	.3125	.3750	.4375	.5000	.5625	.6250	.7500	.8750	1.0000
Feed rates	A	.0001	.0001	.0002	.0002	.0002	.0002	.0003	.0003	.0004	.0005	.0005	.0006	.0007	.0008	.0010	.0011
	B	.0001	.0001	.0002	.0002	.0002	.0002	.0003	.0003	.0004	.0005	.0005	.0006	.0007	.0008	.0010	.0011
	C	.0001	.0001	.0002	.0002	.0002	.0002	.0003	.0003	.0004	.0005	.0005	.0006	.0007	.0008	.0010	.0011
	D	.0001	.0001	.0002	.0002	.0002	.0003	.0004	.0004	.0004	.0005	.0006	.0006	.0007	.0008	.0010	.0011
	E	.0001	.0001	.0002	.0003	.0004	.0004	.0005	.0006	.0006	.0007	.0007	.0009	.0009	.0011	.0012	.0013
	F	.0001	.0002	.0002	.0004	.0005	.0006	.0006	.0007	.0009	.0009	.0011	.0012	.0013	.0015	.0017	.0019
	G	.0002	.0002	.0004	.0006	.0007	.0007	.0009	.0010	.0012	.0013	.0015	.0016	.0017	.0020	.0023	.0025
	I	.0002	.0003	.0005	.0007	.0009	.0011	.0012	.0014	.0016	.0018	.0020	.0022	.0024	.0028	.0031	.0035
	J	.0003	.0004	.0007	.0010	.0012	.0014	.0017	.0019	.0022	.0024	.0027	.0030	.0032	.0037	.0043	.0047
	K	.0004	.0006	.0009	.0014	.0016	.0019	.0022	.0025	.0029	.0032	.0036	.0040	.0043	.0050	.0056	.0063
	N	.0005	.0007	.0011	.0019	.0022	.0025	.0029	.0034	.0038	.0043	.0048	.0053	.0057	.0066	.0075	.0083
	O	.0006	.0010	.0015	.0024	.0029	.0034	.0039	.0045	.0051	.0057	.0063	.0070	.0076	.0088	.0100	.0111
	P	.0008	.0014	.0020	.0033	.0038	.0045	.0052	.0060	.0068	.0076	.0084	.0094	.0100	.0117	.0133	.0148
	R	.0011	.0018	.0027	.0043	.0051	.0060	.0069	.0080	.0091	.0101	.0112	.0125	.0134	.0156	.0177	.0197
	S	.0015	.0024	.0036	.0058	.0067	.0080	.0091	.0106	.0120	.0135	.0149	.0166	.0178	.0207	.0236	.0263



SOLID HM MILLS – CORRECTION FACTORS

1 Slot Milling

Correction factors for cutting speed v_c and feed per tooth f_z for slot milling operations at different depths of cut.

APMX FFW / DC	25 %	50 %	100 %	150 %
	1.25	1.00	0.75	0.50
	1.25	1.00	0.75	0.50

2 Shoulder Milling

Correction factors for cutting speed v_c and feed per tooth f_z for square shoulder milling with < 50 % radial immersion.

APMX EFW / DC	5 %	10 %	15 %	20 %	25 %	30 %	40 %	≥ 50 %
	1.48	1.35	1.27	1.22	1.19	1.16	1.11	1.00
	2.29	1.67	1.40	1.25	1.15	1.09	1.02	1.00

We recommend to avoid milling with 50 % radial immersion.

3a Plain Copy Milling (with Ball Nose Cutters)

Correction factors for cutting speed v_c for plain copy milling at different depths of cut.

APMX FFW / DC	5 %	10 %	15 %	20 %	25 %	30 %	40 %	50 %
	2.29	1.67	1.40	1.25	1.15	1.09	1.02	1.00

3b

Line offset f_e (step-over distance) for achieving a theoretical surface roughness R_{th} .

DC		2	4	8	16	32	63	125	250
2		0.13	0.18	0.25	0.36	0.50	0.70	0.97	1.32
3		0.15	0.22	0.31	0.44	0.62	0.86	1.20	1.66
4		0.18	0.25	0.36	0.50	0.71	1.00	1.39	1.94
5		0.20	0.28	0.40	0.56	0.80	1.12	1.56	2.18
6		0.22	0.31	0.44	0.62	0.87	1.22	1.71	2.40
8		0.25	0.36	0.51	0.71	1.01	1.41	1.98	2.78
10		0.28	0.40	0.57	0.80	1.13	1.58	2.22	3.12
12		0.31	0.44	0.62	0.88	1.24	1.73	2.44	3.43
14		0.33	0.47	0.67	0.95	1.34	1.87	2.63	3.71
16		0.36	0.51	0.72	1.01	1.43	2.00	2.82	3.97
18		0.38	0.54	0.76	1.07	1.52	2.13	2.99	4.21
20		0.40	0.57	0.80	1.13	1.60	2.24	3.15	4.44
22		0.42	0.59	0.84	1.19	1.68	2.35	3.31	4.66
25	0.45	0.63	0.89	1.26	1.79	2.51	3.53	4.97	
28	0.47	0.67	0.95	1.34	1.89	2.65	3.73	5.27	

Line offset dimensions shown are Metric (mm) only.

3c

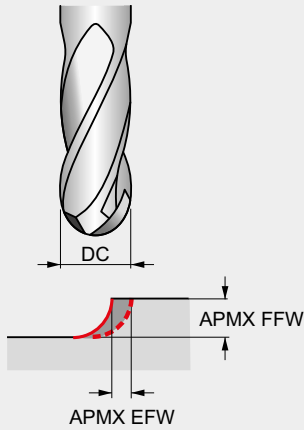

How to use this table to find the correction factor for the feed per tooth (f_z or IPT) for plain copy milling:

1. Find the closest radial immersion (APMX EFW / DC) for your cutting application in the top row of the table.
2. Find your closest axial immersion (APMX FFW / DC) for your cutting application in the left column of the table.
3. The intersection (cell) of the radial and axial immersions is the correction factor for the feed per tooth.

Example for plain copy milling:

1. Applying an 8 mm ball nose cutter with a depth of cut of 0.8 mm (APMX FFW), the aim is to achieve a theoretical surface roughness of 32 μm .
2. The correction factor for cutting speed with an axial immersion of 10% = 1.67 can be found in table 3a.
3. The step-over distance for a R_{th} of 32 μm = 1.01 mm can be found in table 3b.
4. The correction factor for feed per tooth with an axial immersion of 10% and a radial immersion of 1.01 / 8 = 12.6% can be found in table 3c and is in this case 2.33.

Correction factors for feed per tooth f_z for plain copy milling with a line offset < 50% \times DC at different of depths of cut.

APMX FFW	APMX EFW	5 %	10 %	15 %	20 %	25 %	30 %	35 %	40 %	50 %
5 %	$\times f_z$ 	5.26	3.82	3.21	2.87	2.65	2.50	2.40	2.34	2.29
10 %		3.82	2.78	2.33	2.08	1.92	1.82	1.75	1.70	1.67
15 %		3.21	2.33	1.96	1.75	1.62	1.53	1.47	1.43	1.40
20 %		2.87	2.08	1.75	1.56	1.44	1.36	1.31	1.28	1.25
25 %		2.65	1.92	1.62	1.44	1.33	1.26	1.21	1.18	1.15
30 %		2.50	1.82	1.53	1.36	1.26	1.19	1.14	1.11	1.09
35 %		2.40	1.75	1.47	1.31	1.21	1.14	1.10	1.07	1.05
40 %		2.34	1.70	1.43	1.28	1.18	1.11	1.07	1.04	1.02
45 %		2.31	1.68	1.41	1.26	1.16	1.10	1.05	1.03	1.01
50 %		2.29	1.67	1.40	1.25	1.15	1.09	1.05	1.02	1.00

To increase the surface quality, the tool or surface should be included with a tilt angle off 10°– 15°.



SOLID HM BARREL-SHAPE MILL – FEED PER TOOTH TABLE

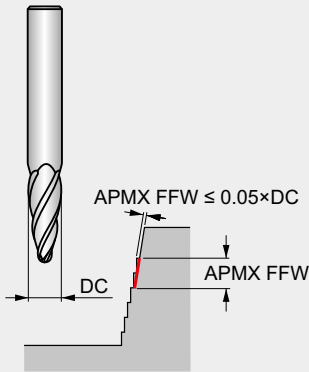

Feed per tooth f_z (mm/rev) depended on the working conditions it might be needed to adjust these values $\pm 25\%$.

How to use this table to find the feed per tooth f_z :

1. Find your Alpha Code on the product page (example: 121F, "F" is the Alpha Code).
2. Find the closest diameter for your cutting application in the top row of the table.
3. Find your Alpha Code in the left column of the table.
4. The intersection (cell) of the Diameter and Alpha Code is the feed per tooth f_z .

**FOR HM S791
BARREL-SHAPE MILLS ONLY**

		\varnothing DC (mm)				
		6.00	8.00	10.00	12.00	16.00
Feed rates	E	0.030	0.039	0.053	0.067	0.096
	F	0.037	0.050	0.064	0.083	0.118
	I	0.062	0.084	0.111	0.141	0.203



SOLID HSS MILLS – FEED PER TOOTH TABLE

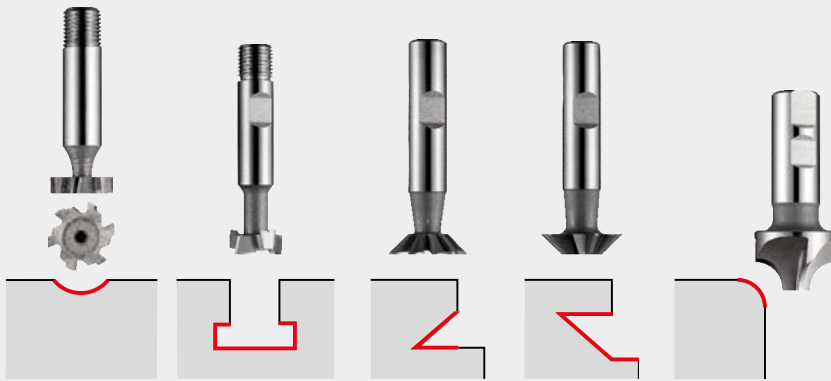

Feed per tooth f_z (mm/rev).

Depended of the working conditions it might be needed to adjust these values $\pm 25\%$.

How to use this table to find the feed per tooth f_z :

1. Find your Alpha Code on the product page (example: 40V, "V" is the Alpha Code).
2. Find the closest diameter for your cutting application in the top row of the table.
3. Find your Alpha Code in the left column of the table.
4. The intersection (cell) of the diameter and Alpha Code is the feed per tooth f_z .

Feed rates for mills: C800, C801, C810, C820, C822, C825, C830, C835, C837, C831, C700, C710, D745, D747, D750, D751, D752, D753, D200, D763.

		\varnothing DC (mm)															
		10.0	12.0	16.0	20.0	25.0	32.0	38.0	50.0	63.0	80.0	100.0	125.0	160.0	200.0	300.0	350.0
Feed rates	P	–	–	–	–	–	0.200	–	0.200	0.200	0.200	0.200	0.200	0.200	0.200	0.200	0.200
	Q	–	–	–	–	–	0.040	–	0.040	0.040	0.040	0.040	0.040	0.040	0.040	0.040	0.040
	R	–	–	–	–	–	0.600	–	0.600	0.600	0.600	0.600	0.600	0.600	0.600	0.600	0.600
	S	0.020	0.020	0.020	0.040	0.040	0.040	0.040	0.050	0.050	0.060	0.070	0.080	0.090	0.100	0.100	0.100
	T	0.020	0.020	0.030	0.050	0.050	0.050	0.060	0.060	0.060	–	–	–	–	–	–	–
	U	0.030	0.030	0.030	0.050	0.060	0.060	0.060	0.060	0.060	–	–	–	–	–	–	–
	V	0.030	0.030	0.040	0.060	0.060	0.060	0.070	0.070	0.070	0.080	0.090	0.100	0.110	0.120	0.120	0.120
	W	0.040	0.050	0.050	0.060	0.060	0.070	0.070	0.070	0.070	0.090	0.100	0.110	0.110	0.120	0.120	0.120
	X	0.050	0.050	0.060	0.070	0.080	0.100	0.110	0.110	0.110	0.110	0.110	0.120	0.130	0.140	0.140	0.140
	Y	0.060	0.060	0.070	0.090	0.100	0.110	0.130	0.130	–	–	–	–	–	–	–	–
Z	0.070	0.070	0.090	0.110	0.120	0.110	0.150	–	–	–	–	–	–	–	–	–	

Feeds f_z shown are Metric (mm) only.



DORMER PRAMET



EVERY MATERIAL

Machining steel, stainless steel, cast iron, super-alloys or non-ferrous materials, all are covered within our calculator app. Download it from your app store today.
Simply Reliable.

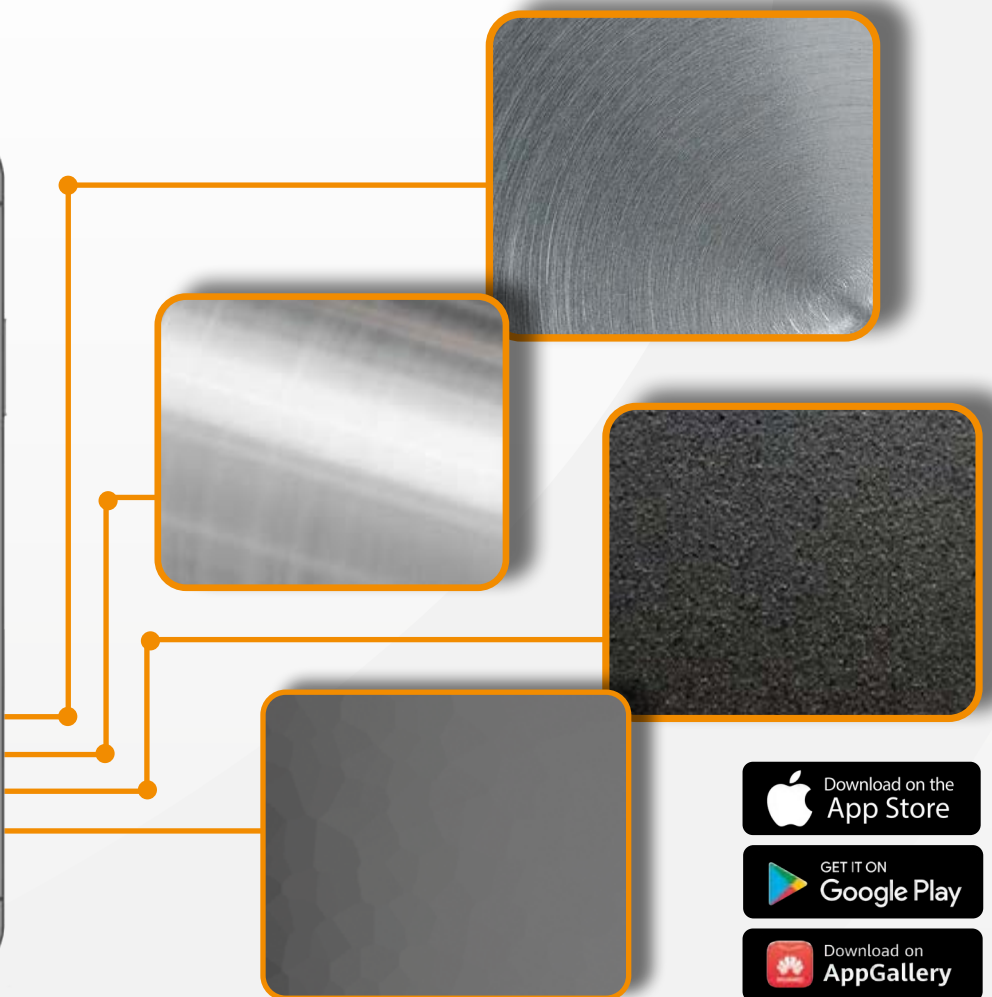



ROTARY BURRS



CARBIDE ROTARY BURRS

Our range of carbide rotary burrs is a high quality and comprehensive program. This includes a variety of designs and shapes to offer an ideal option for the majority of applications in all major industry segments.

FEATURES AND BENEFITS

- The combination of premium grade materials for both the shank and head, with the precise production process, results in the creation of a consistent and secure program of tools.
- Each CUT STYLE has been designed to be the first choice for high performance machining in the relevant material. This includes steels (ST CUT), stainless

steels (VA CUT), non-ferrous materials and plastics (ALUMINIUM CUT), superalloys (AS CUT), fibreglass and composite materials (GRP CUT), and general machining (DC CUT).

SHANK

- Toughened and hardened steel shanks
- Provides rigidity and strength
- Prevents bending and reduces vibration, resulting in improved tool life
- Ground to h6 (carbide) and h7 (steel) for improved holding

BRAZING

- Special brazing elements provide excellent braze strength
- Excellent impact strength to withstand high forces
- Able to withstand higher temperature without failing

CUT STYLES



ST

ST CUT

First choice for high performance machining of **Steels**

- Material specific chip breaker design for higher machining output on steel parts
- Positive geometry, ensures smooth surface finish
- Creates less temperature which helps increase tool life



VA

VA CUT

First choice for high performance machining of **Stainless steels**

- Sharp cutting geometry, reducing the onset of work-hardening
- Increases metal removal rate



AL

ALUMINIUM CUT

First choice for **Non ferrous materials and Plastics**

- High helix and large flute volume for rapid metal removal



CARBIDE ROTARY BURRS



BALL NOSE GEOMETRY

- Skip flute grinding
- Increased strength at the centre
- Reduced chance of swarf congestion
- Improved cutting action closer to the centre



Skip

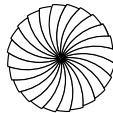

Normal

TiAIN COATING

- Increased tool life in difficult conditions
- Reduced friction improves swarf evacuation
- Helps resist “built-up edge” common with cutting tools with small flute volumes



AS

AS CUT

First choice for **Superalloys**

- Ergonomic
- High quality surface finish
- Fast and smooth cutting action



GRP

GRP CUT

First choice for **Fibreglass and Composite materials**

- Available with Drill Point and End Mill styles
- Designed to reduce splintering and improve entry and exit surface quality



DC

DOUBLE CUT

First choice for **General machining**

- Improves ease of control
- Increases metal removal rate

CARBIDE ROTARY BURRS

FOR BOLT REMOVAL

A specially designed range of burrs to prepare the surface of broken bolts to improve drill location and prevent damaging the threaded hole and component.

FEATURES AND BENEFITS

- Specific diameters and cutting lengths to suit various thread diameters
- Long reach and tapered shanks for easy access
- Developed cutting geometry for machining high tensile materials
- Reduces potential damage to existing threaded holes
- Improves drill location, ensuring damaged bolt is drilled on centre
- Prevents potential scrapage of component
- Highly consistent quality

OPERATIONS

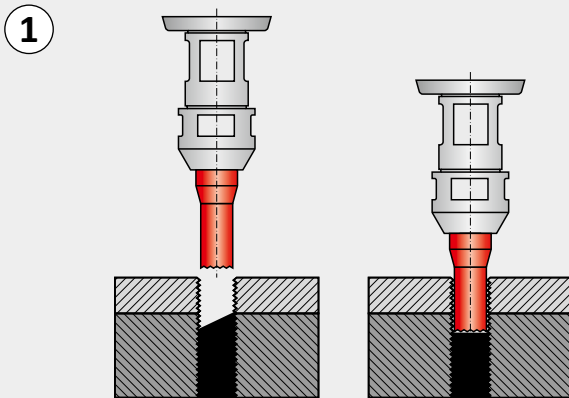

CUT STYLES

PLAIN CYLINDER WITH END CUT



150° COUNTERSINK



HOW TO USE THE TOOLS

- Choose the correct size burr for the broken bolt
- Use a right-handed die grinder
- Ensure the burr is perpendicular to the broken bolt
- Grind the broken surface flat – Operation ①
- Grind into the prepared surface to form a countersink location at the centre point of the bolt – Operation ②



1 P811



2 Rotary Burr - Ball Nosed Tree, Shape F, Bright Finish

DC double cut flute style with close spaced edges for multi-angle contouring, rounding of edges and cutting into hard to reach areas. Carbide design for cutting diameter up to 6 mm; above 6 mm carbide head with toughened and hardened steel shank.

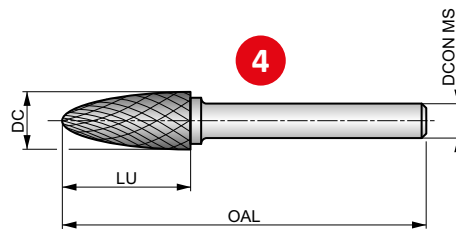

HM	F	Bright
DC	DORMER	



Workpiece material group suitability. Recommended operating speed (RPM) on page 229.

P1.1	P1.2	P1.3	P2.1	P2.2	P2.3	P3.1	P3.2	P3.3	P4.1	P4.2	P4.3	M1.1	M1.2
M2.1	M2.2	M2.3	M3.1	M3.2	M3.3	M4.1	M4.2	K1.1	K1.2	K1.3	K2.1	K2.2	K2.3
K3.1	K3.2	K3.3	K4.1	K4.2	K4.3	K4.4	K4.5	K5.1	K5.2	K5.3	N3.1	N3.2	N3.3
S1.1	S1.2	S1.3	S2.1	S2.2	S3.1	S3.2	S4.1	S4.2	H1.1	H2.1	H2.2	H3.1	H3.2
H4.1	H4.2												

DC≤6.00 mm: DCON MS tolerance h6; DC>6.00 mm: Brazed on steel shank with DCON MS tolerance h7.
Products from this series are also available in set. Please see P880 or P890.

Product	DC	DCON MS	LU	OAL
	(mm)	(mm)	(mm)	(mm)
P811.3X3.0	3.00	3.00	14.00	38.0
P8116.3X3.0	6.30	3.00	12.70	45.0

Pos.	Description
1	Designation of rotary burrs
2	Product description
3	Illustrative picture
4	Schematic drawing of tool
5	Product features

Pos.	Description
6	Deburring operations
7	Material group recommendations
8	Product code
9	Product dimensions

Typical page with rotary burrs displayed – specific page details will differ.



ROTARY BURRS – ICONS OVERVIEW

General Icons

	Primary use
	Possible use

Material Code (BMC)

HM	Hard Material (Solid Carbide)
-----------	-------------------------------

Burr Shape

A	Cylinder Shape without endcut	F	Ball Nosed Tree Shape	L	Ball Nosed Cone Shape
B	Cylinder Shape with endcut	G	Pointed Tree Shape	M	Cone Shape
C	Ball Nosed Cylinder Shape	H	Flame Shape	N	Inverted Cone Shape
D	Ball Shape	J	60° Countersink Shape		
E	Oval Shape	K	90° Countersink Shape		

Burr End Shot

	Drill Point Burr End
	End Cut Burr End
	End Mill Burr End

Coating

	Bright (uncoated)
	Titanium Aluminium Nitride Coating



ROTARY BURRS – ICONS OVERVIEW

Application Angle



60° Countersink



Drill Point 135°



Spot Drill Point 150°



90° Countersink



Drill Point 180°

Burr Cut Flute Style (BTC)



Double Cut Geometry



Aluminium Cut Geometry



Superalloy Cut Geometry



Steel Cut Geometry



Fibreglass and Composite Materials Cut Geometry



Stainless Steel Cut Geometry



Bolt Removal Cut Geometry

Basic Standard Group (BSG)



Dormer Standards

Operations Deburring



Bolt removal operation 1



Curved surface deburring and carving



Inverted back deburring



Bolt removal operation 2



Fillet radii deburring



Plain surface deburring



Closed groove deburring and carving



Free hand deburring and carving



Shoulder deburring



Composite fibre routing



Chamfer deburring



V-groove deburring

Other Icons



Bolt size



ROTARY BURRS – TOOL MATERIALS NAVIGATOR

HM materials

Carbide Materials (or Hard Materials)		<p>A sintered powder metallurgy substrate, consisting of a metallic carbide composite with binder metal. The most central raw material is tungsten carbide (WC). Tungsten carbide contributes to the hardness of the material. Tantalum carbide (TaC), titanium carbide (TiC) and niobium carbide (NbC) complements WC and adjusts the properties to what is desired. These three materials are called cubic carbides. Cobalt (Co) acts as a binder and keeps the material together.</p> <p>Carbide materials are often characterised by high compression strength, high hardness and therefore high wear resistance, but also by limited flexural strength and toughness. Carbide is used in taps, reamers, milling cutters, drills and thread milling cutters.</p>
--	---	--

Surface Treatments

Bright (uncoated)		<p>Bright finish (uncoated surface) improves chip flow in soft or non-ferrous materials and maintains sharp cutting edges in abrasive materials.</p>
------------------------------	---	--

Surface Coatings

Titanium Aluminium Nitride Coating (TiAlN)		<p>Titanium Aluminium Nitride is a multi layer ceramic coating applied by PVD coating technology, which exhibits high toughness and oxidation stability. These properties make it ideal for higher speeds and feeds, while at the same time improving tool life. TiAlN is used in drilling, tapping, and milling applications and can be suitable for use when machining without coolant.</p>
---	---	---



		HM	HM	HM	HM	HM	HM	HM						
Material code (BMC)		HM	HM	HM	HM	HM	HM	HM						
Burr Shape														
Burr end shot														
Coating		Bright	Bright	Bright	Bright	Bright	Bright	Bright	Bright					
Application angle														
Burr Type Code (BTC)		DC	DC	DC	DC	DC	DC	DC	DC					
Basic standard group (BSG)														
Product Family Code		P803	P805	P807	P809	P811	P815	P819	P821					
		3.00 - 16.00	3.00 - 16.00	3.00 - 16.00	3.00 - 16.00	3.00 - 16.00	3.00 - 16.00	3.00 - 16.00	3.00 - 16.00					
		278	279	280	281	282	283	284	285					
P	P1	■	■	■	■	■	■	■	■					
	P2	■	■	■	■	■	■	■	■					
	P3	■	■	■	■	■	■	■	■					
	P4	■	■	■	■	■	■	■	■					
M	M1	■	■	■	■	■	■	■	■					
	M2	■	■	■	■	■	■	■	■					
	M3	■	■	■	■	■	■	■	■					
	M4	■	■	■	■	■	■	■	■					
K	K1	■	■	■	■	■	■	■	■					
	K2	■	■	■	■	■	■	■	■					
	K3	■	■	■	■	■	■	■	■					
	K4	■	■	■	■	■	■	■	■					
	K5	■	■	■	■	■	■	■	■					
N	N1													
	N2													
	N3	■	■	■	■	■	■	■	■					
	N4													
	N5													
S	S1	■	■	■	■	■	■	■	■					
	S2	■	■	■	■	■	■	■	■					
	S3	■	■	■	■	■	■	■	■					
	S4	■	■	■	■	■	■	■	■					
H	H1	■	■	■	■	■	■	■	■					
	H2	■	■	■	■	■	■	■	■					
	H3	■	■	■	■	■	■	■	■					
	H4	■	■	■	■	■	■	■	■					



P803



Rotary Burr - Cylinder with endcut, Shape B, Bright Finish

DC double cut flute style with close spaced edges for trimming and deburring surfaces and right-angled corners. Carbide design for cutting diameter up to 6 mm; above 6 mm carbide head with toughened and hardened steel shank.

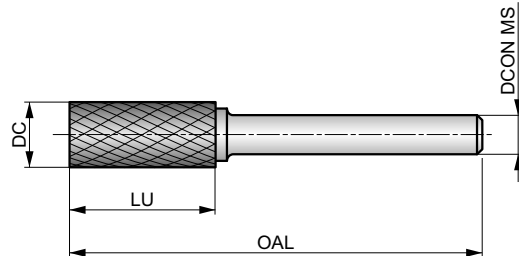

HM	B	
Bright	DC	



Workpiece material group suitability. Recommended operating speed (RPM) on page XY.

P1.1	P1.2	P1.3	P2.1	P2.2	P2.3	P3.1	P3.2	P3.3	P4.1	P4.2	P4.3	M1.1	M1.2
M2.1	M2.2	M2.3	M3.1	M3.2	M3.3	M4.1	M4.2	K1.1	K1.2	K1.3	K2.1	K2.2	K2.3
K3.1	K3.2	K3.3	K4.1	K4.2	K4.3	K4.4	K4.5	K5.1	K5.2	K5.3	N3.1	N3.2	N3.3
S1.1	S1.2	S1.3	S2.1	S2.2	S3.1	S3.2	S4.1	S4.2	H1.1	H2.1	H2.2	H3.1	H3.2
H4.1	H4.2												

DC ≤ 6.00 mm: DCON MS tolerance h6; DC > 6.00 mm: Brazed on steel shank with DCON MS tolerance h7.
Products from this series are also available in set. Please see P880 or P890.

Product	DC (mm)	DCON MS (mm)	LU (mm)	OAL (mm)
P8033.0X3.0	3.00	3.00	14.00	38.0
P8036.3X3.0	6.30	3.00	12.70	45.0
P8036.0X6.0	6.00	6.00	18.00	50.0
P8038.0X6.0	8.00	6.00	19.00	64.0
P8039.6X6.0	9.60	6.00	19.00	64.0
P80312.7X6.0	12.70	6.00	25.00	70.0
P80316.0X6.0	16.00	6.00	25.00	70.0



P805



Rotary Burr - Ball Nosed Cylinder, Shape C, Bright Finish

DC double cut flute style with close spaced edges for trimming and deburring contours and circular arcs. Carbide design for cutting diameter up to 6 mm; above 6 mm carbide head with toughened and hardened steel shank.

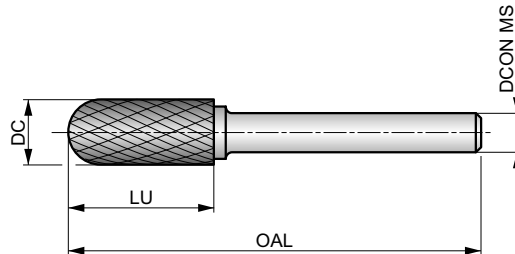

HM	C	Bright
DC	DORMER	



Workpiece material group suitability. Recommended operating speed (RPM) on page XY.

P1.1	P1.2	P1.3	P2.1	P2.2	P2.3	P3.1	P3.2	P3.3	P4.1	P4.2	P4.3	M1.1	M1.2
M2.1	M2.2	M2.3	M3.1	M3.2	M3.3	M4.1	M4.2	K1.1	K1.2	K1.3	K2.1	K2.2	K2.3
K3.1	K3.2	K3.3	K4.1	K4.2	K4.3	K4.4	K4.5	K5.1	K5.2	K5.3	N3.1	N3.2	N3.3
S1.1	S1.2	S1.3	S2.1	S2.2	S3.1	S3.2	S4.1	S4.2	H1.1	H2.1	H2.2	H3.1	H3.2
H4.1	H4.2												

DC ≤ 6.00 mm: DCON MS tolerance h6; DC > 6.00 mm: Brazed on steel shank with DCON MS tolerance h7.
Products from this series are also available in set. Please see P880 or P890.

Product	DC (mm)	DCON MS (mm)	LU (mm)	OAL (mm)
P8053.0X3.0	3.00	3.00	14.00	38.0
P8056.3X3.0	6.30	3.00	12.70	45.0
P8056.0X6.0	6.00	6.00	18.00	50.0
P8058.0X6.0	8.00	6.00	19.00	64.0
P8059.6X6.0	9.60	6.00	19.00	64.0
P80512.7X6.0	12.70	6.00	25.00	70.0
P80516.0X6.0	16.00	6.00	25.00	70.0



P807



Rotary Burr - Ball, Shape D, Bright Finish

DC double cut flute style with close spaced edges for intricate carving, metal engraving and welding preparation. Carbide design for cutting diameter up to 6 mm; above 6 mm carbide head with toughened and hardened steel shank.

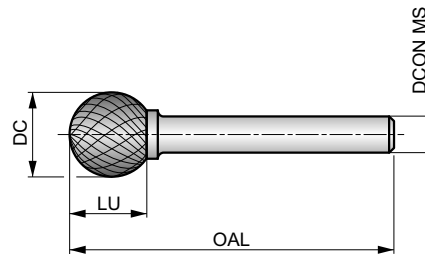

HM	Bright
DC	



Workpiece material group suitability. Recommended operating speed (RPM) on page XY.

P1.1	P1.2	P1.3	P2.1	P2.2	P2.3	P3.1	P3.2	P3.3	P4.1	P4.2	P4.3	M1.1	M1.2
M2.1	M2.2	M2.3	M3.1	M3.2	M3.3	M4.1	M4.2	K1.1	K1.2	K1.3	K2.1	K2.2	K2.3
K3.1	K3.2	K3.3	K4.1	K4.2	K4.3	K4.4	K4.5	K5.1	K5.2	K5.3	N3.1	N3.2	N3.3
S1.1	S1.2	S1.3	S2.1	S2.2	S3.1	S3.2	S4.1	S4.2	H1.1	H2.1	H2.2	H3.1	H3.2
H4.1	H4.2												

DC ≤ 6.00 mm: DCON MS tolerance h6; DC > 6.00 mm: Brazed on steel shank with DCON MS tolerance h7.
Products from this series are also available in set. Please see P880.

Product	DC (mm)	DCON MS (mm)	LU (mm)	OAL (mm)
P8073.0X3.0	3.00	3.00	2.50	38.0
P8074.0X3.0	4.00	3.00	3.40	38.0
P8076.3X3.0	6.30	3.00	5.00	38.0
P8076.0X6.0	6.00	6.00	4.70	50.0
P8078.0X6.0	8.00	6.00	6.00	52.0
P8079.6X6.0	9.60	6.00	8.00	54.0
P80712.7X6.0	12.70	6.00	11.00	56.0
P80716.0X6.0	16.00	6.00	14.00	59.0



P809



Rotary Burr - Oval, Shape E

DC double cut flute style with close spaced edges for round edge contouring. Carbide design for cutting diameter up to 6 mm; above 6 mm carbide head with toughend and hardened steel shank.

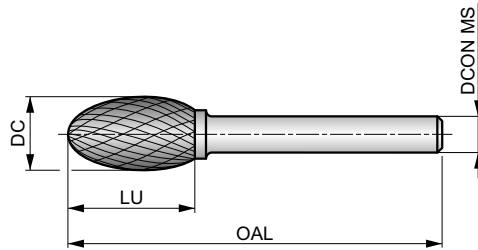

HM	E	Bright
DC		



Workpiece material group suitability. Recommended operating speed (RPM) on page XY.

P1.1	P1.2	P1.3	P2.1	P2.2	P2.3	P3.1	P3.2	P3.3	P4.1	P4.2	P4.3	M1.1	M1.2
■	■	■	■	■	■	■	■	■	■	■	■	■	■
M2.1	M2.2	M2.3	M3.1	M3.2	M3.3	M4.1	M4.2	K1.1	K1.2	K1.3	K2.1	K2.2	K2.3
■	■	■	■	■	■	■	■	■	■	■	■	■	■
K3.1	K3.2	K3.3	K4.1	K4.2	K4.3	K4.4	K4.5	K5.1	K5.2	K5.3	N3.1	N3.2	N3.3
■	■	■	■	■	■	■	■	■	■	■	■	■	■
S1.1	S1.2	S1.3	S2.1	S2.2	S3.1	S3.2	S4.1	S4.2	H1.1	H2.1	H2.2	H3.1	H3.2
■	■	■	■	■	■	■	■	■	■	■	■	■	■
H4.1	H4.2												
■	■												

DC ≤ 6.00 mm: DCON MS tolerance h6; DC > 6.00 mm: Brazed on steel shank with DCON MS tolerance h7.
Products from this series are also available in set. Please see P880.

Product	DC (mm)	DCON MS (mm)	LU (mm)	OAL (mm)
P8093.0X3.0	3.00	3.00	6.00	38.0
P8096.3X3.0	6.30	3.00	9.50	42.0
P8096.0X6.0	6.00	6.00	10.00	50.0
P8098.0X6.0	8.00	6.00	15.00	60.0
P8099.6X6.0	9.60	6.00	16.00	60.0
P80912.7X6.0	12.70	6.00	22.00	67.0
P80916.0X6.0	16.00	6.00	25.00	70.0



P811



Rotary Burr - Ball Nosed Tree, Shape F, Bright Finish

DC double cut flute style with close spaced edges for multi-angle contouring, rounding of edges and cutting into hard to reach areas. Carbide design for cutting diameter up to 6 mm; above 6 mm carbide head with toughened and hardened steel shank.

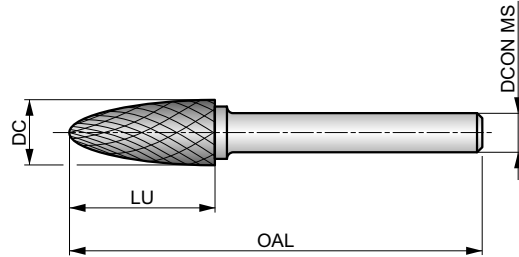

HM	F	Bright
DC	DORMER	



Workpiece material group suitability. Recommended operating speed (RPM) on page XY.

P1.1	P1.2	P1.3	P2.1	P2.2	P2.3	P3.1	P3.2	P3.3	P4.1	P4.2	P4.3	M1.1	M1.2
M2.1	M2.2	M2.3	M3.1	M3.2	M3.3	M4.1	M4.2	K1.1	K1.2	K1.3	K2.1	K2.2	K2.3
K3.1	K3.2	K3.3	K4.1	K4.2	K4.3	K4.4	K4.5	K5.1	K5.2	K5.3	N3.1	N3.2	N3.3
S1.1	S1.2	S1.3	S2.1	S2.2	S3.1	S3.2	S4.1	S4.2	H1.1	H2.1	H2.2	H3.1	H3.2
H4.1	H4.2												

DC ≤ 6.00 mm: DCON MS tolerance h6; DC > 6.00 mm: Brazed on steel shank with DCON MS tolerance h7.
Products from this series are also available in set. Please see P880 or P890.

Product	DC (mm)	DCON MS (mm)	LU (mm)	OAL (mm)
P8113.0X3.0	3.00	3.00	14.00	38.0
P8116.3X3.0	6.30	3.00	12.70	45.0
P8116.0X6.0	6.00	6.00	18.00	50.0
P8118.0X6.0	8.00	6.00	20.00	65.0
P8119.6X6.0	9.60	6.00	19.00	64.0
P81112.7X6.0	12.70	6.00	25.00	70.0
P81116.0X6.0	16.00	6.00	25.00	70.0



P815



Rotary Burr - Flame, Shape H, Bright Finish

DC double cut flute style with close spaced edges for round edge contouring and welding preparation. Carbide design for cutting diameter up to 6 mm; above 6 mm carbide head with toughened and hardened steel shank.

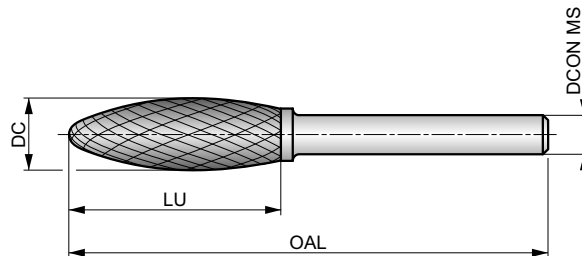

HM	H	Bright
DC	DORMER	



Workpiece material group suitability. Recommended operating speed (RPM) on page XY.

P1.1	P1.2	P1.3	P2.1	P2.2	P2.3	P3.1	P3.2	P3.3	P4.1	P4.2	P4.3	M1.1	M1.2
M2.1	M2.2	M2.3	M3.1	M3.2	M3.3	M4.1	M4.2	K1.1	K1.2	K1.3	K2.1	K2.2	K2.3
K3.1	K3.2	K3.3	K4.1	K4.2	K4.3	K4.4	K4.5	K5.1	K5.2	K5.3	N3.1	N3.2	N3.3
S1.1	S1.2	S1.3	S2.1	S2.2	S3.1	S3.2	S4.1	S4.2	H1.1	H2.1	H2.2	H3.1	H3.2
H4.1	H4.2												

DC ≤ 6.00 mm: DCON MS tolerance h6; DC > 6.00 mm: Brazed on steel shank with DCON MS tolerance h7.
Products from this series are also available in set. Please see P880.

Product	DC (mm)	DCON MS (mm)	LU (mm)	OAL (mm)
P8153.0X3.0	3.00	3.00	6.00	38.0
P8156.0X6.0	6.00	6.00	14.00	50.0
P8158.0X6.0	8.00	6.00	19.00	64.0
P8159.6X6.0	9.60	6.00	19.00	65.0
P81512.7X6.0	12.70	6.00	32.00	77.0
P81516.0X6.0	16.00	6.00	36.00	81.0



P819



Rotary Burr - 90° Countersink, Shape K

DC double cut flute style with close spaced edges for chamfering, making v-cuts and welding preparation. Carbide design for cutting diameter up to 6 mm; above 6 mm carbide head with toughened and hardened steel shank.

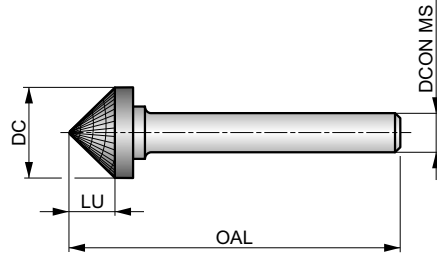

HM	K	Bright
90°	DC	DORMER



Workpiece material group suitability. Recommended operating speed (RPM) on page XY.

P1.1	P1.2	P1.3	P2.1	P2.2	P2.3	P3.1	P3.2	P3.3	P4.1	P4.2	P4.3	M1.1	M1.2
M2.1	M2.2	M2.3	M3.1	M3.2	M3.3	M4.1	M4.2	K1.1	K1.2	K1.3	K2.1	K2.2	K2.3
K3.1	K3.2	K3.3	K4.1	K4.2	K4.3	K4.4	K4.5	K5.1	K5.2	K5.3	N3.1	N3.2	N3.3
S1.1	S1.2	S1.3	S2.1	S2.2	S3.1	S3.2	S4.1	S4.2	H1.1	H2.1	H2.2	H3.1	H3.2
H4.1	H4.2												

DC ≤ 6.00 mm: DCON MS tolerance h6; DC > 6.00 mm: Brazed on steel shank with DCON MS tolerance h7.

Product	DC (mm)	DCON MS (mm)	LU (mm)	OAL (mm)
P8193.0X3.0	3.00	3.00	1.50	38.0
P8196.0X6.0	6.00	6.00	3.00	50.0
P8199.6X6.0	9.60	6.00	4.70	53.0
P81912.7X6.0	12.70	6.00	6.30	55.0
P81916.0X6.0	16.00	6.00	8.00	57.0



P821



Rotary Burr - Ball Nosed Cone, Shape L, Bright Finish

DC double cut flute style with close spaced edges for enlarging holes, rounding edges and surface finishing in tight narrow angles or other hard to reach areas. Carbide design for cutting diameter up to 6 mm; above 6 mm carbide head with toughened and hardened steel shank.

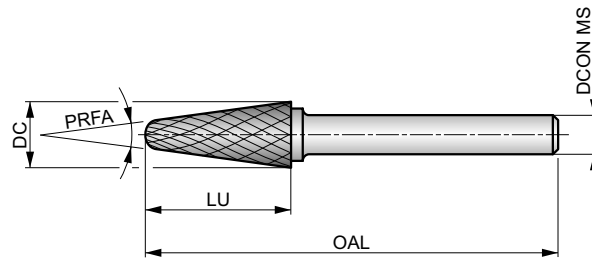

HM	L	Bright
DC	DORMER	



Workpiece material group suitability. Recommended operating speed (RPM) on page XY.

P1.1	P1.2	P1.3	P2.1	P2.2	P2.3	P3.1	P3.2	P3.3	P4.1	P4.2	P4.3	M1.1	M1.2
M2.1	M2.2	M2.3	M3.1	M3.2	M3.3	M4.1	M4.2	K1.1	K1.2	K1.3	K2.1	K2.2	K2.3
K3.1	K3.2	K3.3	K4.1	K4.2	K4.3	K4.4	K4.5	K5.1	K5.2	K5.3	N3.1	N3.2	N3.3
S1.1	S1.2	S1.3	S2.1	S2.2	S3.1	S3.2	S4.1	S4.2	H1.1	H2.1	H2.2	H3.1	H3.2
H4.1	H4.2												

DC ≤ 6.00 mm: DCON MS tolerance h6; DC > 6.00 mm: Brazed on steel shank with DCON MS tolerance h7.
Products from this series are also available in set. Please see P880 or P890.

Product	DC (mm)	DCON MS (mm)	LU (mm)	OAL (mm)	PRFA (°)
P8213.0X3.0	3.00	3.00	14.00	38.0	8
P8216.0X6.0	6.00	6.00	18.00	50.0	14
P8218.0X6.0	8.00	6.00	25.40	70.0	14
P8219.6X6.0	9.60	6.00	30.00	76.0	14
P82112.7X6.0	12.70	6.00	32.00	77.0	14
P82116.0X6.0	16.00	6.00	33.00	78.0	14



ROTARY BURRS – GENERAL HINTS

General hints on carbide burrs

Carbide Burrs are widely used for preparing and finishing components in a wide range of materials. They are generally used by hand and mounted in air driven die-grinders.

Construction and Geometry

1. Toughened and hardened steel shanks improve rigidity and reduce the risk of bending or vibration.
2. Accurately ground shanks improve holding and reduce likelihood of spinning.
3. Special brazing elements prevent high temperature failure and also provide increased strength to withstand pressure and impact.
4. The universal Double Cut (DC) geometry is suitable for a wide range of materials and applications.
5. Material specific geometries are also available suited to Steel (ST), Stainless Steel (VA), Aluminium (AL), Super Alloys (AS) and Fibreglass (GRP).
6. Available with TiAlN coating to increase tool life in abrasive materials.
7. Ball nose burrs are ground with Skip Flute geometry. This provides active geometry towards the centre of the burr, improving the cutting action and reducing the chances of swarf build up and clogging.

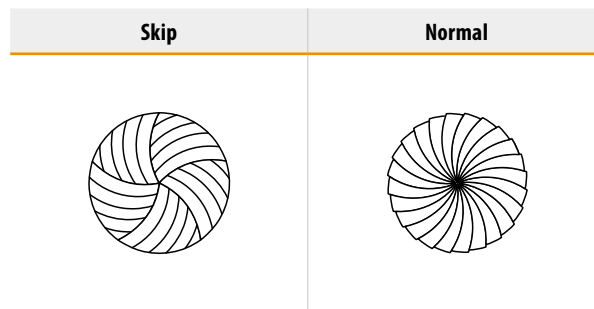

Safety first

1. High speed rotating tools are hazardous and can be dangerous if miss-used.
2. Always disconnect the die grinder from the air supply before attempting to change the burrs.
3. Check the condition of the die grinder and if possible use low vibration versions.
4. Always use the appropriate protective equipment and ensure anyone working close by is also protected.



Personal protective equipment must be worn at all times!



ROTARY BURRS – GENERAL HINTS

Recommendations

- Always use the appropriate speed rated die grinder.
- Routine maintenance of die grinders is important, ensure they are oiled and bearings are not worn.
- Always clean the clamping nut, collet and internal taper of the die grinder when changing a burr.
- Try to avoid mechanical shock and heavy impact of the burrs.
- Try to avoid thermal shock by not allowing the burr to become overheated.
- Don't plunge the burr too deep into the workpiece material or jam the bur into corners or channels.

Trouble shooting using burrs

Problem	Cause
Chipping of Burr Teeth	Running speed too low (revolutions per minute) can cause bouncing (chatter)
	Eccentricity (worn spindle, collet or bearings)
	Plunging and jamming the burr into the workpiece
Clogging of Burr Teeth	Flute length or overall length too long
	Incorrect geometry choice for workpiece material
Premature Wear	Running speed too high (revolutions per minute) for size of burr and workpiece material
	Eccentricity (worn spindle, collet or bearings)
Head Detaches from Shank	Running speed too high (revolutions per minute) causing overheating
	Running for prolonged periods causing overheating



DORMER PRAMET



HELP IS AT HAND

Our technical support team are always at hand to help with any technical questions or queries you have about our technical apps. Use the contact us details to reach out to your local Dormer Pramet sales office.
Simply Reliable.

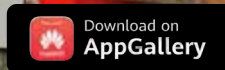



INDEXABLE MILLS



1 SAD11E

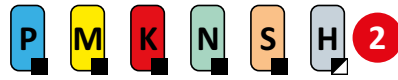

5



FORCE AD11 Square Shoulder Mill with Internal Coolant

90° end and shell mills utilising positive AD. 11 style insert with APMX of 9 mm. Suitable for face, shoulder, slot, helical, trochoidal, ramping and plunge milling. Available in cylindrical, Weldon, Morse taper, modular and arbor (with differential tooth pitch) style, in Ø16 up to Ø125 mm. Body treated for longer tool life.

FORCE AD

KAPR	6	90°
APMX		9.0 mm

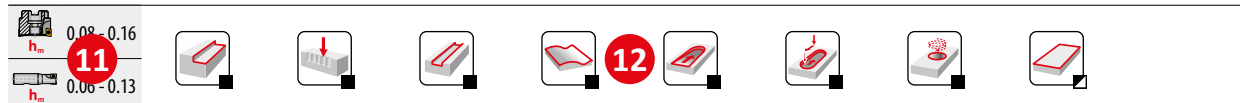
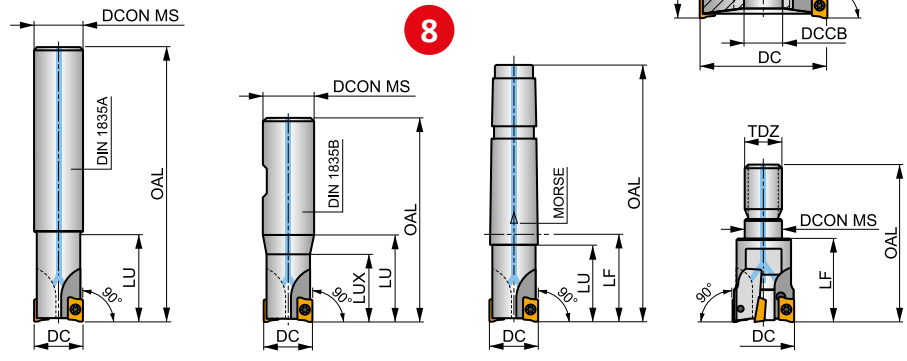
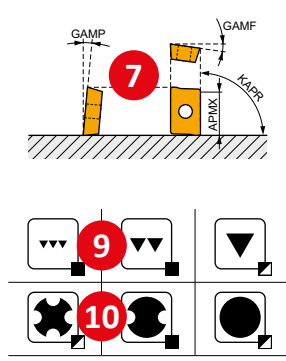

Product	DC	OAL	DCON MS	DCCB	LU	LUX	LF	TDZ	ZTC MS	KWW	KWD	GAMP	GAMP	max.	kg	Material	Coating				
	(mm)	(mm)	(mm)	(mm)	(mm)	(mm)	(mm)	(mm)	(mm)	(mm)	(mm)	(°)	(°)								
14 16A2R02...SAD11E-C	16	160	14	-	24	-	-	-	-	-	-	-12.8	4	16	17	18	19	20	21	22	23
16A2R024A16-SAD11E-C	16	135	16	-	24	-	-	-	-	-	-	-12.8	4	2	30100	0.19	GI169	SQ025	-	-	-
16A2R050A16-SAD11E-C	16	135	16	-	50	-	-	-	-	-	-	-12.8	4	2	28400	0.35	GI169	SQ025	-	-	-
18A2R029A20-SAD11E-C	18	150	20	-	29	-	-	-	-	-	-	-12	4.5	2	27000	0.33	GI169	SQ020	-	-	-
20A2R029A20-SAD11E-C	20	150	20	-	29	-	-	-	-	-	-	-11.5	5	2	27000	0.32	GI169	SQ020	-	-	-
20A2R070A20-SAD11E-C	20	150	20	-	70	-	-	-	-	-	-	-11.5	5	2	27000	0.38	GI169	SQ025	-	-	-
20A3R029A18-SAD11E-C	20	200	18	-	29	-	-	-	-	-	-	-11.5	5	3	27000	0.33	GI169	SQ025	-	-	-
20A3R029A20-SAD11E-C	20	150	20	-	29	-	-	-	-	-	-	-11.5	5	3	27000	0.49	GI169	SQ025	-	-	-
22A3R029A20-SAD11E-C	22	200	20	-	29	-	-	-	-	-	-	-11.5	5	3	25600	0.42	GI169	SQ020	-	-	-
25A3R034A25-SAD11E-C	25	170	25	-	34	-	-	-	-	-	-	-10.2	5	3	24100	-	-	-	-	-	-

GI169	ADMX 11T3..	24	ADEX 11T3..
-------	-------------	-----------	-------------

SQ020	US 62506-T07P	1.2	M 2.5	6	-	-	Flag T07P	-
SQ021	US 62506-T07P	1.2	M 2.5	6	D-T07P/T09P	FG-15	-	-
SQ022	US 62506-T07P	1.2	M 2.5	6	D-T07P/T09P	FG-15	-	HS 0830C
SQ023	US 62506-T07P	1.2	M 2.5	6	D-T07P/T09P	FG-15	-	HS 1030C
SQ025	US 62505-T07P	1.2	M 2.5	5	-	-	Flag T07P	-

AC001	KS 1230	26	K.FMH27
AC002	KS 1635	K.FMH32	
AC003	KS 2040	K.FMH40	



INDEXABLE MILLS – PAGE OVERVIEW

Pos.	Description	Pos.	Description
1	Designation of cutter	14	ISO code of cutter
2	Material group recommendations	15	Dimensions (mm), angles ¹⁾ (°) and connection size code
3	Clamping system of insert	16	Number of teeth
4	Illustrative picture	17	Irregular teeth pitch
5	Tool description	18	Maximum revolutions of cutter
6	Setting angle and maximum theoretical depth of cut (mm)	19	Internal supply of coolant
7	Tool geometry	20	Weight (kg)
8	Schematic drawing of tool	21	Group of compatible inserts ²⁾
9	Achievable quality of surface	22	Group of spare parts ²⁾
10	Character of cut/working conditions	23	Group of special accessories ²⁾
11	Maximum range of mean chip thickness (mm) for end milling cutters and/or shell milling cutters	24	Compatible inserts
12	Product applications	25	Spare parts
13	Shank type	26	Special accessories

¹⁾ γ_f = Radial rake setting angle (GAMF) of insert pocket – see indexable mills technical information

γ_p = Axial rake setting angle (GAMP) of insert pocket – see indexable mills technical information

²⁾ Spare parts and special accessories icons are designed schematically for their ease of understanding. They aren't included in the list of icons. Screws are, in some cases, completed with info on torque value in Nm, length of screw and size of thread.



1

ADMX 11

	W1 (mm)	D1 (mm)	L (mm)	S (mm)
11T3	6.530	2.90	11.00	3.97

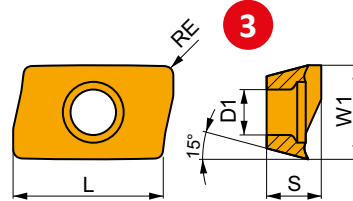

Suitability and starting values for cutting speed (vc), feed (f) and depth of cut (ap). Refer to our Machining Calculator app for further calculations.

Product	RE (mm)	P			M			K			N			S			H		
		vc (m/min)	f (mm/tooth)	ap (mm)	vc (m/min)	f (mm/tooth)	ap (mm)	vc (m/min)	f (mm/tooth)	ap (mm)	vc (m/min)	f (mm/tooth)	ap (mm)	vc (m/min)	f (mm/tooth)	ap (mm)	vc (m/min)	f (mm/tooth)	ap (mm)

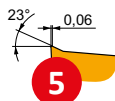

F geometry with very sharp positive design for light machining.

ADMX 11T304SR-F	8215	0.4	245	0.10	2.0	145	0.09	2.0	230	0.10	2.0	735	0.12	2.0	60	0.08	1.6	-	-	-
	M8310	0.4	270	0.10	2.0	135	0.09	2.0	255	0.10	2.0	-	-	-	-	-	-	-	-	-
	M8340	0.4	240	0.10	2.0	140	0.09	2.0	225	0.10	2.0	720	0.12	2.0	60	0.08	1.6	-	-	-
	M9340	0.4	220	0.10	2.0	130	0.09	2.0	205	0.10	2.0	-	-	-	55	0.08	1.6	-	-	-
ADMX 11T308SR-F	8215	0.8	290	0.10	2.0	170	0.09	2.0	275	0.10	2.0	870	0.12	2.0	70	0.08	1.6	-	-	-
	M8330	0.8	285	0.10	2.0	170	0.09	2.0	270	0.10	2.0	855	0.12	2.0	70	0.08	1.6	-	-	-
	M8340	0.8	260	0.10	2.0	155	0.09	2.0	245	0.10	2.0	-	-	-	65	0.08	1.6	-	-	-
	M9340	0.8	340	0.10	2.0	200	0.09	2.0	-	-	-	-	-	85	0.08	1.6	-	-	-	

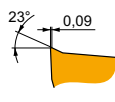

M geometry with positive design for light to medium machining.

ADMX 11T302SR-M	M8330	0.2	190	0.15	4.0	110	0.14	4.0	180	0.15	4.0	-	-	-	45	0.12	3.2	-	-	-
	M8340	0.2	170	0.15	4.0	100	0.14	4.0	160	0.15	4.0	-	-	-	40	0.12	3.2	-	-	-
ADMX 11T304SR-M	8215	0.4	205	0.15	4.0	120	0.14	4.0	190	0.15	4.0	-	-	-	50	0.12	3.2	-	-	-
	M8310	0.4	220	0.15	4.0	110	0.14	4.0	205	0.15	4.0	-	-	-	-	-	-	-	-	-

ADMX 11T304SR-M:M8310 Use full insert specification code when ordering!

Grade

Include colon

ISO insert code



MILLING INSERTS – PAGE OVERVIEW

Pos.	Description	Pos.	Description
1	Designation of insert	7	ISO insert code
2	Table with insert sizes (mm)	8	Grade
3	Schematic drawing of insert	9	Insert radii (mm)
4	Picture of representative insert	10	Geometry description
5	Profile of main cutting edge	11	Application area of insert ¹⁾
6	Icons – specific features and cutting edge type		

¹⁾ Recommendations for cutting speed corrections can be found at the end of Milling chapter in the technical section.



Technical information follows immediately after the milling cutter pages, their compatible inserts and info on starting cutting speeds. These will help you to use the tools in the correct way. If you are unsure how to use or interpret this information, either refer to the technical section at the end of the milling chapter or contact your Dormer Pramet representative.



INDEXABLE MILLS – ICONS OVERVIEW

General icons

	Primary use		Material group P		Finishing – very good surface quality
	Possible use		Material group M		Medium machining – good surface quality
			Material group K		Roughing – unlimited surface roughness
			Material group N		Suitable for stable working conditions
			Material group S		Suitable for unstable working conditions
			Material group H		Suitable for heavy working conditions

Milling Operations

	Face Milling		T-slot Milling		Plunge Milling
	Shallow shoulder milling		Contoured Surfaces (copy milling)		Progressive Plunging
	Deep shoulder milling		Chamfer Milling		Ramping
	Shallow slot milling		Helical interpolation		Rear face milling
	Deep slot milling		Helical interpolation in a pre-drilled hole		

Shanks

	Shell mill DIN 8030		DIN 1835B Weldon Shank		Arbor DIN 69871-1
	Shell mill DIN 8030 – helical mill		Morse shank DIN 228-1		Arbor MAS BT (JIS-B-6339)
	Shell mill DIN 8030 – disc mill		Polygon shank coupling ISO 26623-1		Threaded coupling
	DIN 1835A Cylindrical Shank		Arbor DIN 2080-1		



INDEXABLE MILLS – ICONS OVERVIEW

Features

	First choice		Long overhang		Rounded edge
	Heavy working conditions		Thin-walled and slim workpieces		Edge with facet
	High Feed Cutting		Universal wide range option		Rounded edge with facet
	Insert with Wiper geometry		Sharp edge		Rounded edge with double facet

Others

	Clamping torque of screw (Nm)
	Effective number of teeth
	Number of teeth (helical cutters)

Technical Parts

	Chamfering angle (°)		Hole diameter (mm)		Maximal angle for ramping (°)
	Depth of cut (mm)		Feed (mm/tooth)		Maximal depth per revolution for maximal diameter of hole (mm)
	Maximum cutting depth over the length of cut (mm)		Minimal feed (mm/tooth)		Maximal depth per revolution for minimal diameter of hole (mm)
	Wiper edge length (mm)		Maximal feed (mm/tooth)		Starting feed (mm/tooth)
	Multiplication factor for feed (machining on centre line)		Chipbreaker		Contouring step in conventional milling (mm)
	Multiplication factor for feed (machining off centre line)		Effective working length of tool (mm)		Contouring step in up/down cross milling (mm)
	Multiplication factor for cutting speed		Maximum width of machined area (mm)		Roughness of machined surface R_a (μm)
	Diameter of cutter (mm)		Number of edges in use		Time (min)
	Maximum diameter of cutter (mm)		Number of teeth		Thread pitch
	Effective diameter of cutter (mm)		Ratio (%) of radial width of cut to cutting diameter		Threads per inch
	Cutting depth for plunging (mm)		Ratio (%) of radial width of cut to maximal cutting diameter		
	Effective reach of tool (mm)		Corner radius of insert (mm)		



ISO CODE DESIGNATION – SHELL MILL BODIES

ISO	1	2	3	4	-	5	6	7	8	9	10	11	12
63	A	06	R	-		S	90	A	D	16	E		
ANSI	1	2	3	4	-	5	6	7	8	9	10	11	12
300	F	04	N	-	I	S	90	S	N	12	N	4	

1	1	2	2	3	3	5	6	6	7	7																																					
Cutting diameter		Cutting type, designation and/or size of clamping			No. of working edges		Standard		Clamping designation		Setting angle (KAPR)																																				
					<table border="1" style="width: 100%; text-align: center;"> <tr> <td style="background-color: black; color: white; font-weight: bold;">4</td> <td style="background-color: black; color: white; font-weight: bold;">4</td> </tr> <tr> <th colspan="2">Direction of cut</th> </tr> <tr> <td>R</td> <td></td> </tr> <tr> <td>L</td> <td></td> </tr> <tr> <td>N</td> <td></td> </tr> </table>		4	4	Direction of cut		R		L		N		<table border="1" style="width: 100%; text-align: center;"> <tr> <td style="background-color: black; color: white; font-weight: bold;">I</td> <td style="background-color: black; color: white; font-weight: bold;">(")</td> </tr> </table>		I	(")	<table border="1" style="width: 100%;"> <tr> <td style="background-color: black; color: white; font-weight: bold;">C</td> <td></td> </tr> <tr> <td style="background-color: black; color: white; font-weight: bold;">S</td> <td></td> </tr> <tr> <td style="background-color: black; color: white; font-weight: bold;">W</td> <td></td> </tr> <tr> <td style="background-color: black; color: white; font-weight: bold;">F</td> <td></td> </tr> </table>		C		S		W		F		<table border="1" style="width: 100%;"> <tr> <td style="background-color: black; color: white; font-weight: bold;">90°</td> <td></td> </tr> <tr> <td style="background-color: black; color: white; font-weight: bold;">75°</td> <td></td> </tr> <tr> <td style="background-color: black; color: white; font-weight: bold;">60°</td> <td></td> </tr> <tr> <td style="background-color: black; color: white; font-weight: bold;">45°</td> <td></td> </tr> <tr> <td style="background-color: black; color: white; font-weight: bold;">M0</td> <td></td> </tr> </table>		90°		75°		60°		45°		M0						
							4	4																																							
		Direction of cut																																													
		R																																													
		L																																													
		N																																													
I	(")																																														
C																																															
S																																															
W																																															
F																																															
90°																																															
75°																																															
60°																																															
45°																																															
M0																																															
<table border="1" style="width: 100%;"> <tr> <td style="background-color: black; color: white; font-weight: bold;">A</td> <td>ISO 6462/A DIN 8030/A</td> <td style="background-color: black; color: white; font-weight: bold;">B</td> <td>ISO 6462/B DIN 8030/B</td> <td style="background-color: black; color: white; font-weight: bold;">C</td> <td>ISO 6462/C DIN 8030/C</td> </tr> <tr> <td style="background-color: black; color: white; font-weight: bold;">F</td> <td>DC = 27 mm</td> <td style="background-color: black; color: white; font-weight: bold;">DC = 1.000</td> <td colspan="3" rowspan="5"> </td> </tr> <tr> <td style="background-color: black; color: white; font-weight: bold;">G</td> <td>DC = 32 mm</td> <td style="background-color: black; color: white; font-weight: bold;">DC = 1.250</td> </tr> <tr> <td style="background-color: black; color: white; font-weight: bold;">H</td> <td>DC = 40 mm</td> <td style="background-color: black; color: white; font-weight: bold;">-</td> </tr> <tr> <td style="background-color: black; color: white; font-weight: bold;">J</td> <td>DC = 50 mm</td> <td style="background-color: black; color: white; font-weight: bold;">-</td> </tr> <tr> <td style="background-color: black; color: white; font-weight: bold;">K</td> <td>DC = 60 mm</td> <td style="background-color: black; color: white; font-weight: bold;">-</td> </tr> <tr> <td style="background-color: black; color: white; font-weight: bold;">M</td> <td>DC = 80 mm</td> <td style="background-color: black; color: white; font-weight: bold;">-</td> </tr> <tr> <td colspan="3" style="background-color: black; color: white; font-weight: bold; text-align: center;">T</td> <td colspan="3" rowspan="5"> </td> </tr> <tr> <td colspan="3" style="background-color: black; color: white; font-weight: bold; text-align: center;">F</td> </tr> <tr> <td colspan="3" style="background-color: black; color: white; font-weight: bold; text-align: center;">G</td> </tr> <tr> <td colspan="3" style="background-color: black; color: white; font-weight: bold; text-align: center;">H</td> </tr> <tr> <td colspan="3" style="background-color: black; color: white; font-weight: bold; text-align: center;">J</td> </tr> </table>			A	ISO 6462/A DIN 8030/A	B	ISO 6462/B DIN 8030/B	C	ISO 6462/C DIN 8030/C	F	DC = 27 mm	DC = 1.000				G	DC = 32 mm	DC = 1.250	H	DC = 40 mm	-	J	DC = 50 mm	-	K	DC = 60 mm	-	M	DC = 80 mm	-	T						F			G			H			J		
A	ISO 6462/A DIN 8030/A	B	ISO 6462/B DIN 8030/B	C	ISO 6462/C DIN 8030/C																																										
F	DC = 27 mm	DC = 1.000																																													
G	DC = 32 mm	DC = 1.250																																													
H	DC = 40 mm	-																																													
J	DC = 50 mm	-																																													
K	DC = 60 mm	-																																													
M	DC = 80 mm	-																																													
T																																															
F																																															
G																																															
H																																															
J																																															

8	8	9	9	10	10																																																																																																																																																																																																																																																																																																																																																																							
Insert shape				Insert clearance angle		Cutting edge length																																																																																																																																																																																																																																																																																																																																																																						
H 	O 	P 	R 	A 	B 	<table border="1" style="width: 100%; text-align: center;"> <thead> <tr> <th>IC</th> <th>H</th> <th>O</th> <th>P</th> <th>S</th> <th>T</th> <th>C</th> <th>D</th> <th>E</th> <th>M</th> <th>V</th> <th>W</th> <th>R</th> <th>K</th> </tr> </thead> <tbody> <tr> <td>(mm)</td> <td></td> <td></td> <td></td> <td></td> <td></td> <td></td> <td></td> <td></td> <td></td> <td></td> <td></td> <td></td> <td></td> </tr> <tr> <td>(")</td> <td></td> <td></td> <td></td> <td></td> <td></td> <td></td> <td></td> <td></td> <td></td> <td></td> <td></td> <td></td> <td></td> </tr> <tr> <td>3.97</td> <td></td> <td></td> <td></td> <td>03</td> <td>06</td> <td></td> <td>04</td> <td></td> <td></td> <td>06</td> <td>02</td> <td></td> <td></td> </tr> <tr> <td></td> <td></td> <td></td> <td></td> <td></td> <td></td> <td></td> <td>1.2"</td> <td></td> <td></td> <td></td> <td></td> <td></td> <td></td> </tr> <tr> <td>4.76</td> <td></td> <td></td> <td></td> <td>04</td> <td>08</td> <td>04</td> <td>05</td> <td>04</td> <td>04</td> <td>08</td> <td>L3</td> <td></td> <td></td> </tr> <tr> <td></td> <td></td> <td></td> <td></td> <td></td> <td></td> <td></td> <td>1.5"</td> <td></td> <td></td> <td></td> <td></td> <td></td> <td></td> </tr> <tr> <td>5.56</td> <td></td> <td></td> <td></td> <td>05</td> <td>09</td> <td>05</td> <td>06</td> <td>05</td> <td>05</td> <td>09</td> <td>03</td> <td></td> <td></td> </tr> <tr> <td></td> <td></td> <td></td> <td></td> <td></td> <td></td> <td></td> <td>1.8"</td> <td></td> <td></td> <td></td> <td></td> <td></td> <td></td> </tr> <tr> <td>6.35</td> <td>03</td> <td>02</td> <td>04</td> <td>08</td> <td>11</td> <td>06</td> <td>07</td> <td>08</td> <td>08</td> <td>11</td> <td>04</td> <td>06</td> </tr> <tr> <td></td> <td></td> <td></td> <td></td> <td></td> <td></td> <td></td> <td>2"</td> <td></td> <td></td> <td></td> <td></td> <td></td> <td></td> </tr> <tr> <td>7.94</td> <td>04</td> <td>03</td> <td>05</td> <td>07</td> <td>13</td> <td>08</td> <td>09</td> <td>06</td> <td>07</td> <td>13</td> <td>05</td> <td>07</td> </tr> <tr> <td></td> <td></td> <td></td> <td></td> <td></td> <td></td> <td></td> <td>2.5"</td> <td></td> <td></td> <td></td> <td></td> <td></td> <td></td> </tr> <tr> <td>9.525</td> <td>05</td> <td>04</td> <td>07</td> <td>09</td> <td>16</td> <td>09</td> <td>11</td> <td>09</td> <td>09</td> <td>16</td> <td>06</td> <td>09</td> <td>19</td> </tr> <tr> <td></td> <td></td> <td></td> <td></td> <td></td> <td></td> <td></td> <td>3"</td> <td></td> <td></td> <td></td> <td></td> <td></td> <td></td> </tr> <tr> <td>12.7</td> <td>07</td> <td>05</td> <td>09</td> <td>12</td> <td>22</td> <td>12</td> <td>15</td> <td>13</td> <td>12</td> <td>22</td> <td>08</td> <td>12</td> </tr> <tr> <td></td> <td></td> <td></td> <td></td> <td></td> <td></td> <td></td> <td>4"</td> <td></td> <td></td> <td></td> <td></td> <td></td> <td></td> </tr> <tr> <td>15.875</td> <td>09</td> <td>06</td> <td>11</td> <td>15</td> <td>27</td> <td>16</td> <td>19</td> <td>16</td> <td>15</td> <td>27</td> <td>10</td> <td>15</td> </tr> <tr> <td></td> <td></td> <td></td> <td></td> <td></td> <td></td> <td></td> <td>5"</td> <td></td> <td></td> <td></td> <td></td> <td></td> <td></td> </tr> <tr> <td>19.05</td> <td>11</td> <td>07</td> <td>13</td> <td>19</td> <td>33</td> <td>19</td> <td>23</td> <td>19</td> <td>19</td> <td>33</td> <td>13</td> <td>19</td> </tr> <tr> <td></td> <td></td> <td></td> <td></td> <td></td> <td></td> <td></td> <td>6"</td> <td></td> <td></td> <td></td> <td></td> <td></td> <td></td> </tr> <tr> <td>25.4</td> <td>14</td> <td>10</td> <td>18</td> <td>25</td> <td>44</td> <td>25</td> <td>31</td> <td>26</td> <td>25</td> <td>44</td> <td>17</td> <td>25</td> </tr> <tr> <td></td> <td></td> <td></td> <td></td> <td></td> <td></td> <td></td> <td>8"</td> <td></td> <td></td> <td></td> <td></td> <td></td> <td></td> </tr> <tr> <td>31.75</td> <td>18</td> <td>13</td> <td>23</td> <td>31</td> <td>54</td> <td>32</td> <td>38</td> <td>32</td> <td>31</td> <td>54</td> <td>21</td> <td>31</td> </tr> <tr> <td></td> <td></td> <td></td> <td></td> <td></td> <td></td> <td></td> <td>10"</td> <td></td> <td></td> <td></td> <td></td> <td></td> <td></td> </tr> <tr> <td></td> <td></td> <td></td> <td></td> <td></td> <td></td> <td></td> <td>1 1/4"</td> <td></td> <td></td> <td></td> <td></td> <td></td> <td></td> </tr> </tbody> </table>		IC	H	O	P	S	T	C	D	E	M	V	W	R	K	(mm)														(")														3.97				03	06		04			06	02										1.2"							4.76				04	08	04	05	04	04	08	L3										1.5"							5.56				05	09	05	06	05	05	09	03										1.8"							6.35	03	02	04	08	11	06	07	08	08	11	04	06								2"							7.94	04	03	05	07	13	08	09	06	07	13	05	07								2.5"							9.525	05	04	07	09	16	09	11	09	09	16	06	09	19								3"							12.7	07	05	09	12	22	12	15	13	12	22	08	12								4"							15.875	09	06	11	15	27	16	19	16	15	27	10	15								5"							19.05	11	07	13	19	33	19	23	19	19	33	13	19								6"							25.4	14	10	18	25	44	25	31	26	25	44	17	25								8"							31.75	18	13	23	31	54	32	38	32	31	54	21	31								10"														1 1/4"						
IC	H	O	P	S	T			C	D	E	M	V	W	R	K																																																																																																																																																																																																																																																																																																																																																													
(mm)																																																																																																																																																																																																																																																																																																																																																																												
(")																																																																																																																																																																																																																																																																																																																																																																												
3.97				03	06				04			06	02																																																																																																																																																																																																																																																																																																																																																															
									1.2"																																																																																																																																																																																																																																																																																																																																																																			
4.76				04	08			04	05	04	04	08	L3																																																																																																																																																																																																																																																																																																																																																															
									1.5"																																																																																																																																																																																																																																																																																																																																																																			
5.56				05	09			05	06	05	05	09	03																																																																																																																																																																																																																																																																																																																																																															
									1.8"																																																																																																																																																																																																																																																																																																																																																																			
6.35	03	02	04	08	11			06	07	08	08	11	04	06																																																																																																																																																																																																																																																																																																																																																														
									2"																																																																																																																																																																																																																																																																																																																																																																			
7.94	04	03	05	07	13	08	09	06	07	13	05	07																																																																																																																																																																																																																																																																																																																																																																
							2.5"																																																																																																																																																																																																																																																																																																																																																																					
9.525	05	04	07	09	16	09	11	09	09	16	06	09	19																																																																																																																																																																																																																																																																																																																																																															
							3"																																																																																																																																																																																																																																																																																																																																																																					
12.7	07	05	09	12	22	12	15	13	12	22	08	12																																																																																																																																																																																																																																																																																																																																																																
							4"																																																																																																																																																																																																																																																																																																																																																																					
15.875	09	06	11	15	27	16	19	16	15	27	10	15																																																																																																																																																																																																																																																																																																																																																																
							5"																																																																																																																																																																																																																																																																																																																																																																					
19.05	11	07	13	19	33	19	23	19	19	33	13	19																																																																																																																																																																																																																																																																																																																																																																
							6"																																																																																																																																																																																																																																																																																																																																																																					
25.4	14	10	18	25	44	25	31	26	25	44	17	25																																																																																																																																																																																																																																																																																																																																																																
							8"																																																																																																																																																																																																																																																																																																																																																																					
31.75	18	13	23	31	54	32	38	32	31	54	21	31																																																																																																																																																																																																																																																																																																																																																																
							10"																																																																																																																																																																																																																																																																																																																																																																					
							1 1/4"																																																																																																																																																																																																																																																																																																																																																																					

11	11
WIPER edge clearance angle	
N ALP = 0°	C ALP = 7°
D ALP = 15°	E ALP = 20°
	F ALP = 25°
P ALP = 11°	

12	12												
Cutting edge length (width)													
CW (mm) / (")	APMX												
<table border="1" style="width: 100%;"> <tr> <th>CW</th> <th>1/16"</th> </tr> <tr> <td>0.156</td> <td>2.5</td> </tr> <tr> <td>0.187</td> <td>3</td> </tr> <tr> <td>0.250</td> <td>4</td> </tr> <tr> <td>0.313</td> <td>5</td> </tr> <tr> <td>0.375</td> <td>6</td> </tr> </table>	CW	1/16"	0.156	2.5	0.187	3	0.250	4	0.313	5	0.375	6	
CW	1/16"												
0.156	2.5												
0.187	3												
0.250	4												
0.313	5												
0.375	6												



ISO CODE DESIGNATION – END SHOULDER MILL BODIES

ISO	1	2	3	4	5	6	7	-	8	9	10	11	12	13
ANSI	1	2	3	4	5	6	7	-	8	9	10	11	12	13
	32	A	4	R	042	B	32	-		S	A	D	11	E
	125	A	4	R	150	W	125	-	I	S	A	D	11	E

1	1	2	2	5	5	6	6	7	7		
Cutting diameter		Cutter type and setting angle				Overhang		Shank designation		Shank size	
 DC		A E J N H K				(mm)				6 – 40 mm .250" – 1.250"	
 DC						(")		B W ISO 3338-2, DIN 1835B		6 – 50 mm .375" – 2.000"	
 DC		3 3		4 4				E - ISO 296, DIN 228-1		1 – 6 -	
 DC		No. of working edges		Direction of cut				G - ISO 297, DIN 208-1		40 – 50 mm -	
 DCX		R L N				H - ISO/DIS 7388-1, DIN 69871-1		N - ISO 12 164-1, DIN 69893		30 – 50 mm -	
				X - MAS BT		- R8 R8		- CA ANSI B5.50		- 1.250" 30 – 50 - 3 – 10 - - 40 / 50	

8	8	9	9	10	10																																																																																																																																																																						
Insert shape		Insert clearance angle		Cutting edge length																																																																																																																																																																							
H 	O 	P 	R 	A 	B 																																																																																																																																																																						
S 	T 	C 	D 	C 	D 																																																																																																																																																																						
E 	M 	V 	W 	E 	F 																																																																																																																																																																						
L 	A 	B 	K 	G 	N 																																																																																																																																																																						
				P 	O Special																																																																																																																																																																						
<table border="1" style="width: 100%; border-collapse: collapse; font-size: 8px;"> <thead> <tr> <th style="width: 5%;">IC</th> <th style="width: 5%;">H</th> <th style="width: 5%;">O</th> <th style="width: 5%;">P</th> <th style="width: 5%;">S</th> <th style="width: 5%;">T</th> <th style="width: 5%;">C</th> <th style="width: 5%;">D</th> <th style="width: 5%;">E</th> <th style="width: 5%;">M</th> <th style="width: 5%;">V</th> <th style="width: 5%;">W</th> <th style="width: 5%;">R</th> <th style="width: 5%;">K</th> </tr> </thead> <tbody> <tr> <td>3.97</td> <td></td> <td></td> <td></td> <td>03</td> <td>06</td> <td></td> <td>04</td> <td></td> <td></td> <td>06</td> <td>02</td> <td></td> <td></td> </tr> <tr> <td>4.76</td> <td></td> <td></td> <td></td> <td>04</td> <td>08</td> <td>04</td> <td>05</td> <td>04</td> <td>04</td> <td>08</td> <td>L3</td> <td></td> <td></td> </tr> <tr> <td>5.56</td> <td></td> <td></td> <td></td> <td>05</td> <td>09</td> <td>05</td> <td>06</td> <td>05</td> <td>05</td> <td>09</td> <td>03</td> <td></td> <td></td> </tr> <tr> <td>6.35</td> <td>03</td> <td>02</td> <td>04</td> <td>08</td> <td>11</td> <td>06</td> <td>07</td> <td>08</td> <td>08</td> <td>11</td> <td>04</td> <td>06</td> <td></td> </tr> <tr> <td>7.94</td> <td>04</td> <td>03</td> <td>05</td> <td>07</td> <td>13</td> <td>08</td> <td>09</td> <td>06</td> <td>07</td> <td>13</td> <td>05</td> <td>07</td> <td></td> </tr> <tr> <td>9.525</td> <td>05</td> <td>04</td> <td>07</td> <td>09</td> <td>16</td> <td>09</td> <td>11</td> <td>09</td> <td>09</td> <td>16</td> <td>06</td> <td>09</td> <td>19</td> </tr> <tr> <td>12.7</td> <td>07</td> <td>05</td> <td>09</td> <td>12</td> <td>22</td> <td>12</td> <td>15</td> <td>13</td> <td>12</td> <td>22</td> <td>08</td> <td>12</td> <td></td> </tr> <tr> <td>15.875</td> <td>09</td> <td>06</td> <td>11</td> <td>15</td> <td>27</td> <td>16</td> <td>19</td> <td>16</td> <td>15</td> <td>27</td> <td>10</td> <td>15</td> <td></td> </tr> <tr> <td>19.05</td> <td>11</td> <td>07</td> <td>13</td> <td>19</td> <td>33</td> <td>19</td> <td>23</td> <td>19</td> <td>19</td> <td>33</td> <td>13</td> <td>19</td> <td></td> </tr> <tr> <td>25.4</td> <td>14</td> <td>10</td> <td>18</td> <td>25</td> <td>44</td> <td>25</td> <td>31</td> <td>26</td> <td>25</td> <td>44</td> <td>17</td> <td>25</td> <td></td> </tr> <tr> <td>31.75</td> <td>18</td> <td>13</td> <td>23</td> <td>31</td> <td>54</td> <td>32</td> <td>38</td> <td>32</td> <td>31</td> <td>54</td> <td>21</td> <td>31</td> <td></td> </tr> </tbody> </table>		IC	H	O	P	S	T	C	D	E	M	V	W	R	K	3.97				03	06		04			06	02			4.76				04	08	04	05	04	04	08	L3			5.56				05	09	05	06	05	05	09	03			6.35	03	02	04	08	11	06	07	08	08	11	04	06		7.94	04	03	05	07	13	08	09	06	07	13	05	07		9.525	05	04	07	09	16	09	11	09	09	16	06	09	19	12.7	07	05	09	12	22	12	15	13	12	22	08	12		15.875	09	06	11	15	27	16	19	16	15	27	10	15		19.05	11	07	13	19	33	19	23	19	19	33	13	19		25.4	14	10	18	25	44	25	31	26	25	44	17	25		31.75	18	13	23	31	54	32	38	32	31	54	21	31			
IC	H	O	P	S	T	C	D	E	M	V	W	R	K																																																																																																																																																														
3.97				03	06		04			06	02																																																																																																																																																																
4.76				04	08	04	05	04	04	08	L3																																																																																																																																																																
5.56				05	09	05	06	05	05	09	03																																																																																																																																																																
6.35	03	02	04	08	11	06	07	08	08	11	04	06																																																																																																																																																															
7.94	04	03	05	07	13	08	09	06	07	13	05	07																																																																																																																																																															
9.525	05	04	07	09	16	09	11	09	09	16	06	09	19																																																																																																																																																														
12.7	07	05	09	12	22	12	15	13	12	22	08	12																																																																																																																																																															
15.875	09	06	11	15	27	16	19	16	15	27	10	15																																																																																																																																																															
19.05	11	07	13	19	33	19	23	19	19	33	13	19																																																																																																																																																															
25.4	14	10	18	25	44	25	31	26	25	44	17	25																																																																																																																																																															
31.75	18	13	23	31	54	32	38	32	31	54	21	31																																																																																																																																																															

8	9	9	13	13						
Standard	Clamping designation		Wiper edge clearance angle							
I (")	C 	W 								
	S 	F 	<table border="1" style="width: 100%; border-collapse: collapse; font-size: 8px;"> <tr> <td style="padding: 2px;">N ALP = 0°</td> <td style="padding: 2px;">C ALP = 7°</td> <td style="padding: 2px;">P ALP = 11°</td> </tr> <tr> <td style="padding: 2px;">D ALP = 15°</td> <td style="padding: 2px;">E ALP = 20°</td> <td style="padding: 2px;">F ALP = 25°</td> </tr> </table>		N ALP = 0°	C ALP = 7°	P ALP = 11°	D ALP = 15°	E ALP = 20°	F ALP = 25°
N ALP = 0°	C ALP = 7°	P ALP = 11°								
D ALP = 15°	E ALP = 20°	F ALP = 25°								

ISO CODE DESIGNATION – MILLING INSERTS

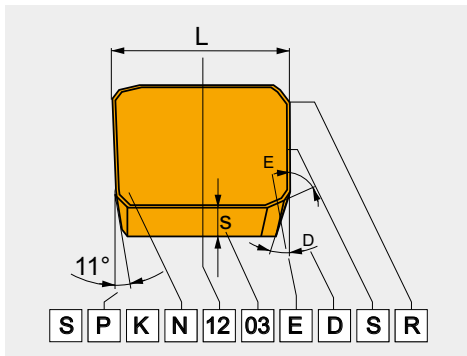

ISO	1	2	3	4
	S	P	G	N
ANSI	1	2	3	4
	S	P	G	N

1				2				4					
Insert shape				Insert clearance angle				Insert type					
H	O	P	R	A	3°	B	5°	N	[Diagrams]				
S	T	C	D	C	7°	D	15°	R	[Diagrams]				
E	M	V	W	E	20°	F	25°	F	[Diagrams]				
L	A	B	K	G	30°	N	0°	A	[Diagrams]				
				P	11°	O	Special	M	[Diagrams]				
								G	[Diagrams]				
								W	40–60°	[Diagrams]			
								T	[Diagrams]				
								Q	[Diagrams]				
								U	[Diagrams]				
								B	70–90°	[Diagrams]			
								H	[Diagrams]				
								C	[Diagrams]				
								J	[Diagrams]				
								X	Special				

3 Tolerances

	(mm)			(")		
	M (±)	S (±)	IC (±)	M (±)	S (±)	IC (±)
A	0.005	0.025	0.025	0.0002"	0.001"	0.0010"
F	0.005	0.025	0.013	0.0002"	0.001"	0.0005"
C	0.013	0.025	0.025	0.0005"	0.001"	0.0010"
H	0.013	0.025	0.013	0.0005"	0.001"	0.0005"
E	0.025	0.025	0.025	0.0010"	0.001"	0.0010"
G	0.025	0.130	0.025	0.0010"	0.005"	0.0010"
J	0.005	0.025	0.05 – 0.13	0.0002"	0.001"	0.002" – 0.005"
K	0.013	0.025	0.05 – 0.13	0.0005"	0.001"	0.002" – 0.005"
L	0.025	0.025	0.05 – 0.13	0.0010"	0.001"	0.002" – 0.005"
M	0.08 – 0.18	0.130	0.05 – 0.13	0.003" – 0.007"	0.005"	0.002" – 0.005"
N	0.08 – 0.18	0.025	0.05 – 0.13	0.003" – 0.007"	0.001"	0.002" – 0.005"
U	0.05 – 0.38	0.130	0.05 – 0.13	0.005" – 0.015"	0.005"	0.003" – 0.010"

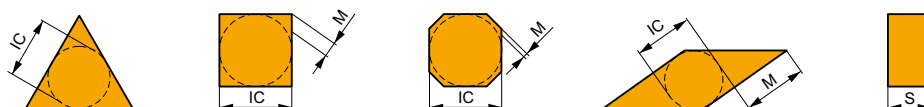



ISO CODE DESIGNATION – MILLING INSERTS

5		6		7		8		9		10	
12	12	03	03	08	ED		S		R	-	
5a	6a	7a	8	9							
4	2	2					S		R	-	
4	2	ED									

5													5													
Cutting edge length																										
I.C.	H	O	P	S	T	C	D	E	M	V	W	R	K													
(mm)																										
3.97				03	06		04				06	02														
5/32"													1.2"													
4.76				04	08	04	05	04	04	08	L3															
3/16"													1.5"													
5.56				05	09	05	06	05	05	09	03															
7/32"													1.8"													
6.35	03	02	04	08	11	06	07	08	08	11	04	06														
1/4"													2"													
7.94	04	03	05	07	13	08	09	06	07	13	05	07														
5/16"													2.5"													
9.525	05	04	07	09	16	09	11	09	09	16	06	09	19													
3/8"													3"													
12.7	07	05	09	12	22	12	15	13	12	22	08	12														
1/2"													4"													
15.875	09	06	11	15	27	16	19	16	15	27	10	15														
5/8"													5"													
19.05	11	07	13	19	33	19	23	19	19	33	13	19														
3/4"													6"													
25.4	14	10	18	25	44	25	31	26	25	44	17	25														
5/1"													8"													
31.75	18	13	23	31	54	32	38	32	31	54	21	31														
1 1/4"													10"													

6		7																																																																										
Thickness		Cutting edge angles																																																																										
<table border="1"> <thead> <tr> <th rowspan="2">Symbol</th> <th colspan="2">S</th> </tr> <tr> <th>(mm)</th> <th>(")</th> </tr> </thead> <tbody> <tr><td>01</td><td>1.59</td><td>1/16"</td></tr> <tr><td>T1</td><td>1.98</td><td>5/64"</td></tr> <tr><td>02</td><td>2.38</td><td>3/32"</td></tr> <tr><td>03</td><td>3.18</td><td>1/8"</td></tr> <tr><td>T3</td><td>3.97</td><td>5/32"</td></tr> <tr><td>04</td><td>4.76</td><td>3/16"</td></tr> <tr><td>05</td><td>5.56</td><td>7/32"</td></tr> <tr><td>06</td><td>6.35</td><td>1/4"</td></tr> <tr><td>07</td><td>7.94</td><td>5/16"</td></tr> <tr><td>09</td><td>9.52</td><td>3/8"</td></tr> </tbody> </table>		Symbol	S		(mm)	(")	01	1.59	1/16"	T1	1.98	5/64"	02	2.38	3/32"	03	3.18	1/8"	T3	3.97	5/32"	04	4.76	3/16"	05	5.56	7/32"	06	6.35	1/4"	07	7.94	5/16"	09	9.52	3/8"	<table border="1"> <thead> <tr> <th colspan="2">KAPR</th> <th colspan="2">ALP</th> </tr> </thead> <tbody> <tr><td>A</td><td>45°</td><td>A</td><td>3°</td></tr> <tr><td>D</td><td>60°</td><td>B</td><td>5°</td></tr> <tr><td>E</td><td>75°</td><td>C</td><td>7°</td></tr> <tr><td>F</td><td>85°</td><td>D</td><td>15°</td></tr> <tr><td>P</td><td>90°</td><td>E</td><td>20°</td></tr> <tr><td rowspan="3">Z</td><td rowspan="3">Special</td><td>F</td><td>25°</td></tr> <tr><td>G</td><td>30°</td></tr> <tr><td>N</td><td>0°</td></tr> <tr><td rowspan="2">Z</td><td rowspan="2">Special</td><td>P</td><td>11°</td></tr> <tr><td>Z</td><td>Special</td></tr> </tbody> </table>		KAPR		ALP		A	45°	A	3°	D	60°	B	5°	E	75°	C	7°	F	85°	D	15°	P	90°	E	20°	Z	Special	F	25°	G	30°	N	0°	Z	Special	P	11°	Z	Special
Symbol	S																																																																											
	(mm)	(")																																																																										
01	1.59	1/16"																																																																										
T1	1.98	5/64"																																																																										
02	2.38	3/32"																																																																										
03	3.18	1/8"																																																																										
T3	3.97	5/32"																																																																										
04	4.76	3/16"																																																																										
05	5.56	7/32"																																																																										
06	6.35	1/4"																																																																										
07	7.94	5/16"																																																																										
09	9.52	3/8"																																																																										
KAPR		ALP																																																																										
A	45°	A	3°																																																																									
D	60°	B	5°																																																																									
E	75°	C	7°																																																																									
F	85°	D	15°																																																																									
P	90°	E	20°																																																																									
Z	Special	F	25°																																																																									
		G	30°																																																																									
		N	0°																																																																									
Z	Special	P	11°																																																																									
		Z	Special																																																																									
ZZ – Special																																																																												

ANSI																																																																																																																																																											
5a				6a				7a																																																																																																																																																			
Inscribed circle				Thickness				Corner radius																																																																																																																																																			
<table border="1"> <thead> <tr> <th rowspan="2">Symbol</th> <th colspan="2">I.C.</th> </tr> <tr> <th>(mm)</th> <th>(")</th> </tr> </thead> <tbody> <tr><td>1</td><td>3.175</td><td>1/8"</td></tr> <tr><td>1.2</td><td>3.969</td><td>5/32"</td></tr> <tr><td>1.5</td><td>4.763</td><td>3/16"</td></tr> <tr><td>1.8</td><td>5.556</td><td>7/32"</td></tr> <tr><td>2</td><td>6.350</td><td>1/4"</td></tr> <tr><td>2.5</td><td>7.938</td><td>5/16"</td></tr> <tr><td>3</td><td>9.525</td><td>3/8"</td></tr> <tr><td>4</td><td>12.700</td><td>1/2"</td></tr> <tr><td>5</td><td>15.875</td><td>5/8"</td></tr> <tr><td>6</td><td>19.050</td><td>3/4"</td></tr> <tr><td>7</td><td>22.225</td><td>7/8"</td></tr> <tr><td>8</td><td>25.400</td><td>1"</td></tr> <tr><td>10</td><td>31.750</td><td>5/4"</td></tr> <tr><td>12</td><td>38.100</td><td>6/4"</td></tr> </tbody> </table>				Symbol	I.C.		(mm)	(")	1	3.175	1/8"	1.2	3.969	5/32"	1.5	4.763	3/16"	1.8	5.556	7/32"	2	6.350	1/4"	2.5	7.938	5/16"	3	9.525	3/8"	4	12.700	1/2"	5	15.875	5/8"	6	19.050	3/4"	7	22.225	7/8"	8	25.400	1"	10	31.750	5/4"	12	38.100	6/4"	<table border="1"> <thead> <tr> <th rowspan="2">Symbol</th> <th colspan="2">S</th> </tr> <tr> <th>(mm)</th> <th>(")</th> </tr> </thead> <tbody> <tr><td>1</td><td>1.588</td><td>1/16"</td></tr> <tr><td>1.2</td><td>1.984</td><td>5/64"</td></tr> <tr><td>1.5</td><td>2.381</td><td>3/32"</td></tr> <tr><td>2</td><td>3.175</td><td>1/8"</td></tr> <tr><td>2.5</td><td>3.969</td><td>5/32"</td></tr> <tr><td>3</td><td>4.763</td><td>3/16"</td></tr> <tr><td>3.5</td><td>5.556</td><td>7/32"</td></tr> <tr><td>4</td><td>6.350</td><td>1/4"</td></tr> <tr><td>5</td><td>7.938</td><td>5/16"</td></tr> <tr><td>6</td><td>9.525</td><td>3/8"</td></tr> <tr><td>7</td><td>11.113</td><td>7/16"</td></tr> <tr><td>8</td><td>12.700</td><td>1/2"</td></tr> <tr><td>9</td><td>14.288</td><td>9/16"</td></tr> <tr><td>10</td><td>15.875</td><td>5/8"</td></tr> </tbody> </table>				Symbol	S		(mm)	(")	1	1.588	1/16"	1.2	1.984	5/64"	1.5	2.381	3/32"	2	3.175	1/8"	2.5	3.969	5/32"	3	4.763	3/16"	3.5	5.556	7/32"	4	6.350	1/4"	5	7.938	5/16"	6	9.525	3/8"	7	11.113	7/16"	8	12.700	1/2"	9	14.288	9/16"	10	15.875	5/8"	<table border="1"> <thead> <tr> <th rowspan="2">Symbol</th> <th colspan="2">RE</th> </tr> <tr> <th>(mm)</th> <th>(")</th> </tr> </thead> <tbody> <tr><td>0</td><td>0</td><td>0"</td></tr> <tr><td>0.2</td><td>0.099</td><td>1/256"</td></tr> <tr><td>0.5</td><td>0.198</td><td>1/128"</td></tr> <tr><td>1</td><td>0.397</td><td>1/64"</td></tr> <tr><td>2</td><td>0.794</td><td>1/32"</td></tr> <tr><td>3</td><td>1.191</td><td>3/64"</td></tr> <tr><td>4</td><td>1.588</td><td>1/16"</td></tr> <tr><td>5</td><td>1.984</td><td>5/64"</td></tr> <tr><td>6</td><td>2.381</td><td>3/32"</td></tr> <tr><td>7</td><td>2.778</td><td>7/64"</td></tr> <tr><td>8</td><td>3.175</td><td>1/8"</td></tr> <tr><td>10</td><td>3.969</td><td>5/32"</td></tr> <tr><td>12</td><td>4.763</td><td>3/16"</td></tr> <tr><td>14</td><td>5.556</td><td>7/32"</td></tr> <tr><td>16</td><td>6.350</td><td>1/4"</td></tr> </tbody> </table>				Symbol	RE		(mm)	(")	0	0	0"	0.2	0.099	1/256"	0.5	0.198	1/128"	1	0.397	1/64"	2	0.794	1/32"	3	1.191	3/64"	4	1.588	1/16"	5	1.984	5/64"	6	2.381	3/32"	7	2.778	7/64"	8	3.175	1/8"	10	3.969	5/32"	12	4.763	3/16"	14	5.556	7/32"	16	6.350	1/4"
Symbol	I.C.																																																																																																																																																										
	(mm)	(")																																																																																																																																																									
1	3.175	1/8"																																																																																																																																																									
1.2	3.969	5/32"																																																																																																																																																									
1.5	4.763	3/16"																																																																																																																																																									
1.8	5.556	7/32"																																																																																																																																																									
2	6.350	1/4"																																																																																																																																																									
2.5	7.938	5/16"																																																																																																																																																									
3	9.525	3/8"																																																																																																																																																									
4	12.700	1/2"																																																																																																																																																									
5	15.875	5/8"																																																																																																																																																									
6	19.050	3/4"																																																																																																																																																									
7	22.225	7/8"																																																																																																																																																									
8	25.400	1"																																																																																																																																																									
10	31.750	5/4"																																																																																																																																																									
12	38.100	6/4"																																																																																																																																																									
Symbol	S																																																																																																																																																										
	(mm)	(")																																																																																																																																																									
1	1.588	1/16"																																																																																																																																																									
1.2	1.984	5/64"																																																																																																																																																									
1.5	2.381	3/32"																																																																																																																																																									
2	3.175	1/8"																																																																																																																																																									
2.5	3.969	5/32"																																																																																																																																																									
3	4.763	3/16"																																																																																																																																																									
3.5	5.556	7/32"																																																																																																																																																									
4	6.350	1/4"																																																																																																																																																									
5	7.938	5/16"																																																																																																																																																									
6	9.525	3/8"																																																																																																																																																									
7	11.113	7/16"																																																																																																																																																									
8	12.700	1/2"																																																																																																																																																									
9	14.288	9/16"																																																																																																																																																									
10	15.875	5/8"																																																																																																																																																									
Symbol	RE																																																																																																																																																										
	(mm)	(")																																																																																																																																																									
0	0	0"																																																																																																																																																									
0.2	0.099	1/256"																																																																																																																																																									
0.5	0.198	1/128"																																																																																																																																																									
1	0.397	1/64"																																																																																																																																																									
2	0.794	1/32"																																																																																																																																																									
3	1.191	3/64"																																																																																																																																																									
4	1.588	1/16"																																																																																																																																																									
5	1.984	5/64"																																																																																																																																																									
6	2.381	3/32"																																																																																																																																																									
7	2.778	7/64"																																																																																																																																																									
8	3.175	1/8"																																																																																																																																																									
10	3.969	5/32"																																																																																																																																																									
12	4.763	3/16"																																																																																																																																																									
14	5.556	7/32"																																																																																																																																																									
16	6.350	1/4"																																																																																																																																																									

8		8	
Cutting edge design			
F	Sharp edges	E	Rounded edges
T	Edges with facet	S	Rounded edges with facet
K	Edges with double facet	P	Rounded edges with double facet

9		9	
Feed direction			
R		N	
L			

















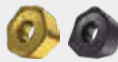

10		10	
Chip breaker design			



INDEXABLE MILLS – NAVIGATOR

FACE MILLING



	SHN06C		SHN09C		SPN13		FSB22X												
	45°		45°		57°		60°												
	APMX (mm)	3.0	APMX (mm)	5.0	APMX (mm)	10.0	APMX (mm)	15.0											
	DC (mm)	25 – 125	DC (mm)	50 – 315	DC (mm)	100 – 315	DC (mm)	125 – 315											
Cylindrical shank																			
Weldon		DC = 25 – 32 (mm)																	
Modular		DC = 25 – 40 (mm)																	
Shell mill		DC = 40 – 125 (mm)																	
Page	📖 301		📖 305		📖 309		📖 313												
ISO	P	M	K		H	P	M	K											
Insert shape																			
Inserts	HNGX 0604 XNGX 0604		HNGX 0906 XNGX 0906		PNM. 1308 XN.. 1308		SB.. 2207												
No. of cutting edges	12 / 1		12 / 1		10 / 1		4 / 1												
Face milling 	■		■		■		■												
Chamfer milling 	■		■																
Helical interpolation 																			
Progressive plunging 	■		■																
Ramping 	■		■																
Shape surfaces milling (copy milling) 																			
Shallow shoulder milling 																			
Shallow slot milling 																			
Plunge milling 																			

■ Primary use ▣ Possible use



SHN06C



PRAMET



ECON HN06 45° Face Mill with Double Negative Design and Internal Coolant

Highly productive 45° face mill utilising double sided HN.. 06 style inserts with APMX of 3 mm. Roughing, finishing and chamfering. Economical insert with 12 cutting edges. Differential tooth pitch. Weldon, modular and arbor style available in range from Ø25 up to Ø125 mm. Body treated for longer tool life.

KAPR	45°
APMX	3.0 mm

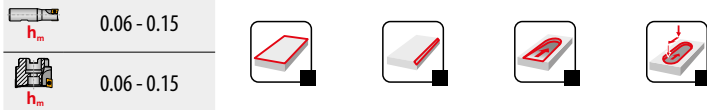
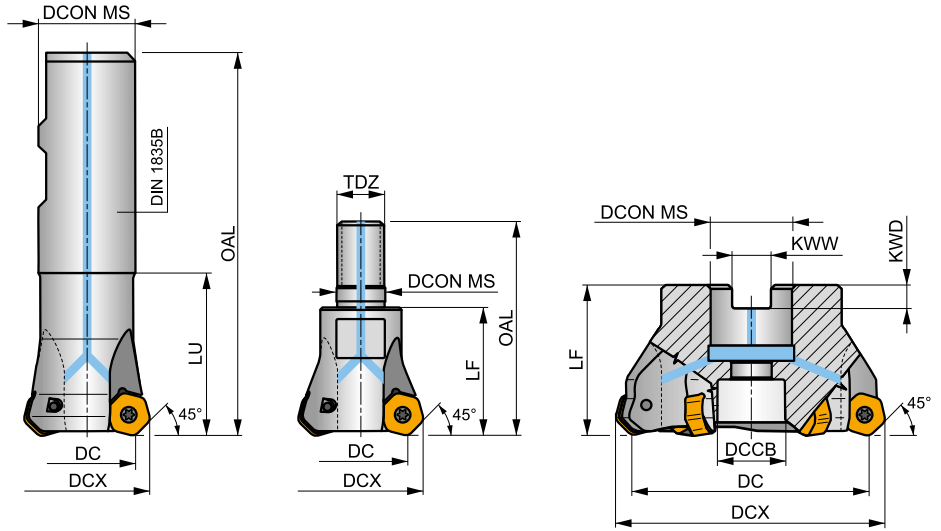
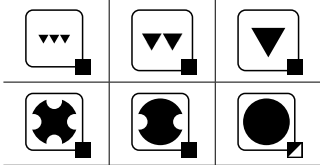
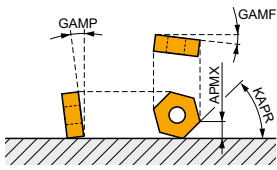

Product	DC	DCX	OAL	DCON MS	DCCB	LU	LF	TDZ	KWW	KWD	GAMF	GAMP	max.	kg	ISO 642 DIN 8030	FA010	FA011	FA012	FA013	AC001	AC002	AC003	
	(mm)	(mm)	(mm)	(mm)	(mm)	(mm)	(mm)	(mm)	(mm)	(mm)	(°)	(°)											
25N2R042B25-SHN06C-C	25	32.2	99	25	-	42	-	-	-	-	-7	-7	2	-	17400	✓	0.36	GI204	FA010	-	-	-	-
32N3R042B32-SHN06C-C	32	39.3	103	32	-	42	-	-	-	-	-7	-7	3	-	15400	✓	0.59	GI204	FA010	-	-	-	-
32N3R043M16-SHN06C-C	32	39.3	66	17	-	-	43	M16	-	-	-7	-7	3	-	-	✓	0.26	GI204	FA010	-	-	-	-
40A05R-S45HN06C-C	40	47.3	-	16	14	-	40	-	8.4	5.6	-7	-7	5	✓	13800	✓	0.37	GI204	FA012	-	-	-	-
50A04R-S45HN06C-C	50	57.3	-	22	18	-	40	-	10.4	6.3	-7	-7	4	✓	12300	✓	0.61	GI204	FA013	-	-	-	-
50A06R-S45HN06C-C	50	57.3	-	22	18	-	40	-	10.4	6.3	-7	-7	6	✓	12300	✓	0.41	GI204	FA013	-	-	-	-
63A06R-S45HN06C-C	63	70.3	-	22	18	-	40	-	10.4	6.3	-7	-7	6	✓	11000	✓	0.56	GI204	FA013	-	-	-	-
63A08R-S45HN06C-C	63	70.3	-	22	18	-	40	-	10.4	6.3	-7	-7	8	✓	11000	✓	0.69	GI204	FA013	-	-	-	-
80A07R-S45HN06C-C	80	86.8	-	27	38	-	50	-	12.4	7	-7	-7	7	✓	9700	✓	1.10	GI204	FA011	AC001	-	-	-
80A10R-S45HN06C-C	80	86.8	-	27	38	-	50	-	12.4	7	-7	-7	10	✓	9700	✓	0.19	GI204	FA011	AC001	-	-	-
100A08R-S45HN06C-C	100	107.1	-	32	45	-	50	-	14.4	8	-7	-7	8	✓	8700	✓	2.07	GI204	FA011	AC002	-	-	-
100A12R-S45HN06C-C	100	107.1	-	32	45	-	50	-	14.4	8	-7	-7	12	✓	8700	✓	1.82	GI204	FA011	AC002	-	-	-
125A10R-S45HN06C-C	125	132.2	-	40	56	-	63	-	16.4	9	-7	-7	10	✓	7800	✓	3.62	GI204	FA011	AC003	-	-	-

GI204	HNGX 0604AN..	XNGX 0604AN..

FA010	US 3007-T09P	2.0	M 3	7.3	-	-	Flag T09P	-
FA011	US 3007-T09P	2.0	M 3	7.3	D-T07P/T09P	FG-15	-	-
FA012	US 3007-T09P	2.0	M 3	7.3	D-T07P/T09P	FG-15	-	HS 0830C
FA013	US 3007-T09P	2.0	M 3	7.3	D-T07P/T09P	FG-15	-	HS 1030C



AC001	KS 1230	K.FMH27
AC002	KS 1635	K.FMH32
AC003	KS 2040	K.FMH40

HNGX 06



	IC	D1	S
	(mm)	(mm)	(mm)
0604	10.500	3.70	4.76

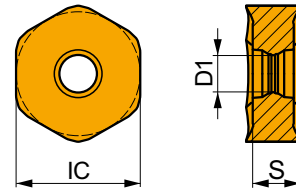

Suitability and starting values for cutting speed (vc), feed (f) and depth of cut (ap). Refer to our Machining Calculator app for further calculations.

Product	RE	P			M			K			N			S			H		
		vc	f	ap	vc	f	ap	vc	f	ap	vc	f	ap	vc	f	ap	vc	f	ap
	(mm)	(m/min)	(mm/tooth)	(mm)	(m/min)	(mm/tooth)	(mm)	(m/min)	(mm/tooth)	(mm)	(m/min)	(mm/tooth)	(mm)	(m/min)	(mm/tooth)	(mm)	(m/min)	(mm/tooth)	(mm)

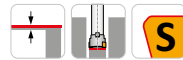
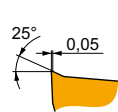

F geometry with highly positive design for light machining.

Product	RE	vc	f	ap	vc	f	ap	vc	f	ap	vc	f	ap	vc	f	ap	vc	f	ap
HNGX 0604ANSN-F		315	0.11	1.7	185	0.10	1.7	-	-	-	-	-	-	-	-	-	-	-	-
M6330		265	0.11	1.7	185	0.10	1.7	-	-	-	-	-	-	-	-	-	-	-	-
M8310		345	0.11	1.7	175	0.10	1.7	-	-	-	-	-	-	-	-	-	-	-	-
M8330		305	0.11	1.7	180	0.10	1.7	-	-	-	-	-	-	-	-	-	-	-	-
M8340		285	0.11	1.7	170	0.10	1.7	-	-	-	-	-	-	-	-	-	-	-	-
M9340		365	0.11	1.7	215	0.10	1.7	-	-	-	-	-	-	-	-	-	-	-	-

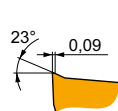

M geometry with highly positive design for medium machining.

Product	RE	vc	f	ap	vc	f	ap	vc	f	ap	vc	f	ap	vc	f	ap	vc	f	ap
HNGX 0604ANSN-M		300	0.13	2.0	180	0.13	2.0	285	0.13	2.0	-	-	-	-	-	-	-	-	-
M5315		425	0.13	2.0	-	-	-	400	0.13	2.0	-	-	-	-	-	-	-	-	-
M6330		255	0.13	2.0	180	0.13	2.0	-	-	-	-	-	-	-	-	-	-	-	-
M8310		325	0.13	2.0	165	0.13	2.0	305	0.13	2.0	-	-	-	-	-	-	-	-	-
M8330		295	0.13	2.0	175	0.13	2.0	280	0.13	2.0	-	-	-	-	-	-	-	-	-
M8340		265	0.13	2.0	155	0.13	2.0	250	0.13	2.0	-	-	-	-	-	-	-	-	-
M9315		410	0.13	2.0	-	-	-	385	0.13	2.0	-	-	-	-	-	-	-	-	-
M9325		375	0.13	2.0	-	-	-	355	0.13	2.0	-	-	-	-	-	-	-	-	-
M9340		345	0.13	2.0	205	0.13	2.0	-	-	-	-	-	-	-	-	-	-	-	-

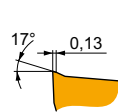

R geometry with highly positive design for medium to heavy machining.

Product	RE	vc	f	ap	vc	f	ap	vc	f	ap	vc	f	ap	vc	f	ap	vc	f	ap
HNGX 0604ANSN-R		280	0.18	1.8	165	0.18	1.8	265	0.18	1.8	-	-	-	-	-	-	55	0.12	1.0
M5315		370	0.18	1.8	-	-	-	350	0.18	1.8	-	-	-	-	-	-	70	0.12	1.0
M8310		300	0.18	1.8	150	0.18	1.8	285	0.18	1.8	-	-	-	-	-	-	60	0.12	1.0
M8330		275	0.18	1.8	165	0.18	1.8	260	0.18	1.8	-	-	-	-	-	-	55	0.12	1.0
M8340		250	0.18	1.8	150	0.18	1.8	235	0.18	1.8	-	-	-	-	-	-	-	-	-
M9325		345	0.18	1.8	-	-	-	325	0.18	1.8	-	-	-	-	-	-	65	0.12	1.0



XNGX 06

	IC (mm)	D1 (mm)	S (mm)
0604	10.500	3.70	4.76

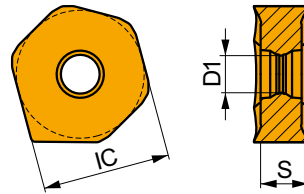

Suitability and starting values for cutting speed (vc), feed (f) and depth of cut (ap). Refer to our Machining Calculator app for further calculations.

Product	RE (mm)	P			M			K			N			S			H		
		vc (m/min)	f (mm/tooth)	ap (mm)	vc (m/min)	f (mm/tooth)	ap (mm)	vc (m/min)	f (mm/tooth)	ap (mm)	vc (m/min)	f (mm/tooth)	ap (mm)	vc (m/min)	f (mm/tooth)	ap (mm)	vc (m/min)	f (mm/tooth)	ap (mm)

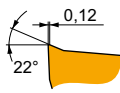

Wiper design for improved surface finish.

XNGX 0604ANSN	8215	-	■	290	0.13	1.8	▣	170	0.12	1.8	■	275	0.13	1.8	-	-	-	-	-	-	-	-	-	-	-	-	-	-	-	-	-	-	-	-	-
----------------------	-------------	---	---	-----	------	-----	---	-----	------	-----	---	-----	------	-----	---	---	---	---	---	---	---	---	---	---	---	---	---	---	---	---	---	---	---	---	---



a_e / DC	5 %	10 %	15 %	20 %	25 %	30 %	40 %	50 %	60 %	70 %	75 %	80 %	90 %	100 %
	1.48	1.35	1.27	1.22	1.19	1.16	1.11	1.08	1.05	1.03	1.00	1.00	1.00	1.00
	2.20	1.60	1.35	1.20	1.10	0.95	0.85	0.75	0.85	0.95	1.00	1.00	1.00	1.00
	0.64	0.64	0.64	0.64	0.64	0.65	0.65	0.67	0.68	0.71	0.72	0.74	0.79	1.00

	HNGX 06-F	HNGX 06-M	HNGX 06-R	XNGX 06
	-	-	-	-
	1.12	0.80	0.80	4.15

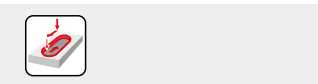
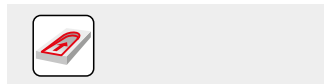
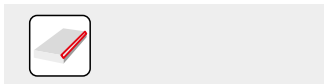
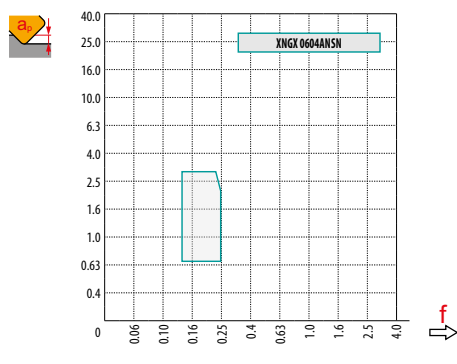
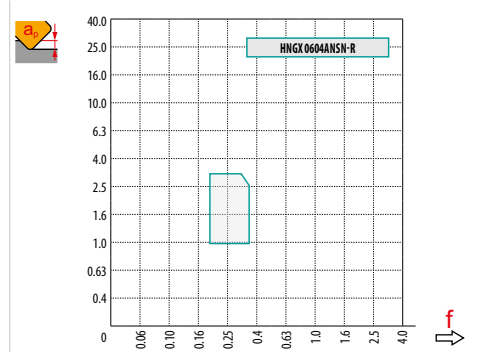
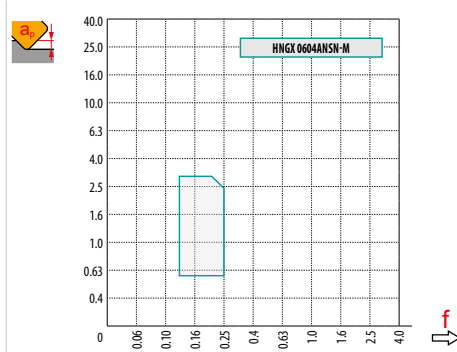
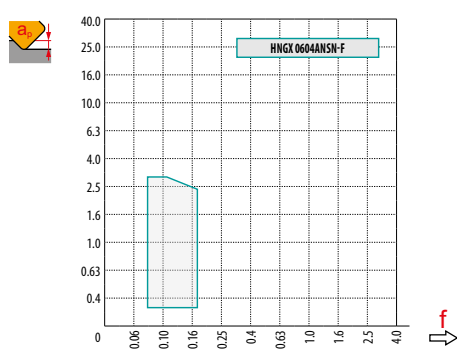

DC	X.V	f_{max}
25	1.31	0.24
32	1.36	0.28
40	1.40	0.31
50	1.45	0.35
63	1.49	0.39
80	1.54	0.44
100	1.59	0.49
125	1.64	0.55

DC	RPMX	APMX/I
25	2.7	3.0/65
32	1.9	3.0/89
40	1.5	2.5/100
50	1.1	1.9/100
63	0.9	1.4/100
80	0.6	1.0/100
100	0.5	0.8/100
125	0.4	0.6/100

	0.9
--	-----



SHN09C

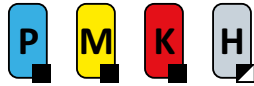

PRAMET



ECON HN09 45° Face Mill with Double Negative Design and Internal Coolant

Highly productive 45° face mill utilising double sided HN.. 09 style inserts with APMX of 5 mm. Roughing, finishing and chamfering. Economical insert with 12 cutting edges. Differential tooth pitch. Arbor style only in range from Ø50 up to Ø315 mm. Body treated for longer tool life.

KAPR	45°
APMX	5.0 mm

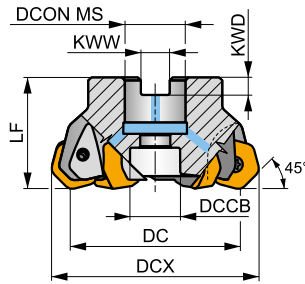
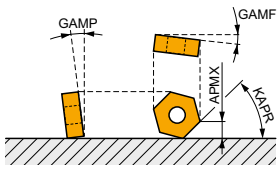

DC 50 - 125 mm

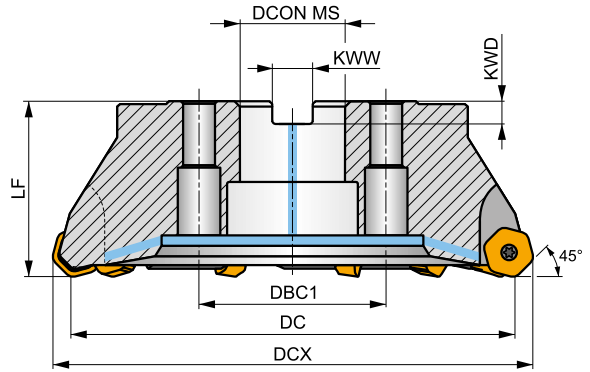

DC 160 - 315 mm

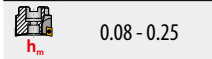
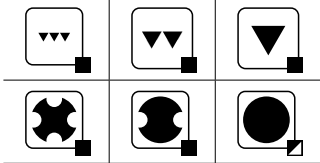

Product	DC	DCX	LF	DCON MS	DCCB	DBC1	KWW	KWD	GAMF	GAMP	max.	kg	ISO 6462 DIN 8030	FA023	FA021	AC001	AC002	AC003	
	(mm)	(mm)	(mm)	(mm)	(mm)	(mm)	(mm)	(mm)	(°)	(°)									
50A04R-S45HN09C-CF	50	61.7	40	22	18	-	10.4	6.3	-7	-7	4	✓	7900	✓	0.38	GI252	FA023	-	-
63A06R-S45HN09C-CF	63	74.7	40	22	18	-	10.4	6.3	-7	-7	6	✓	7000	✓	0.54	GI252	FA023	-	-
80A06R-S45HN09C-CF	80	91.7	50	27	38	-	12.4	7	-7	-7	6	✓	6200	✓	1.06	GI252	FA021	AC001	-
80A08R-S45HN09C-CF	80	91.7	50	27	38	-	12.4	7	-7	-7	8	✓	6200	✓	1.06	GI252	FA021	AC001	-
100A06R-S45HN09C-CF	100	111.7	50	32	45	-	14.4	8	-7	-7	6	✓	5600	✓	1.76	GI252	FA021	AC002	-
100A08R-S45HN09C-CF	100	111.7	50	32	45	-	14.4	8	-7	-7	8	✓	5600	✓	1.76	GI252	FA021	AC002	-
100A10R-S45HN09C-CF	100	111.7	50	32	45	-	14.4	8	-8	-7	10	-	5600	✓	1.76	GI252	FA021	AC002	-
125A06R-S45HN09C-CF	125	136.7	63	40	56	-	16.4	9	-7	-7	6	✓	5000	✓	3.36	GI252	FA021	AC003	-
125A08R-S45HN09C-CF	125	136.7	63	40	56	-	16.4	9	-7	-7	8	✓	4900	✓	3.72	GI252	FA021	AC003	-
125A10R-S45HN09C-CF	125	136.7	63	40	56	-	16.4	9	-7	-7	10	✓	5000	✓	3.36	GI252	FA021	AC003	-
125A12R-S45HN09C-CF	125	136.7	63	40	56	-	16.4	9	-8	-7	12	-	5000	✓	3.36	GI252	FA021	AC003	-
160C08R-S45HN09C-CF	160	171.7	63	40	-	66.7	16.4	9	-7	-7	8	✓	4400	✓	6.30	GI252	FA026	-	-
160C12R-S45HN09C-CF	160	171.7	63	40	-	66.7	16.4	9	-7	-7	12	✓	4400	✓	6.46	GI252	FA026	-	-
160C14R-S45HN09C-CF	160	171.7	63	40	-	66.7	16.4	9	-7	-7	14	✓	4400	✓	6.45	GI252	FA026	-	-
200C10R-S45HN09C-CF	200	211.7	63	60	-	101.6	25.7	14	-7	-7	10	✓	3900	✓	11.37	GI252	FA027	-	-
250C14R-S45HN09C-CF	250	261.7	63	60	-	101.6	25.7	14	-7	-7	14	✓	3500	✓	18.50	GI252	FA028	-	-
315C16R-S45HN09C-CF	315	326.7	80	60	-	101.6	25.7	14	-7	-7	16	✓	3100	✓	37.00	GI252	FA029	-	-

GI252	HNGX 0906AN..	XNGX 0906AN..
-------	---------------	---------------

FA021	US 54511-T15P	5.0	M 4.5	11	D-T08P/T15P	FG-15	-	-	-	-	-	-	-	-	-	-	-	-	-
FA023	US 54511-T15P	5.0	M 4.5	11	D-T08P/T15P	FG-15	HS 1030C	-	-	-	-	-	-	-	-	-	-	-	-



FA026	US 54511-T15P	5.0	M 4.5	11	D-T08P/T15P	FG-15	HS 1240C	CAC 160C	HSD 0825C	HXK 5	–	–
FA027	US 54511-T15P	5.0	M 4.5	11	D-T08P/T15P	FG-15	HS 1655C	CAC 200C	HSD 1025C	HXK 7	–	–
FA028	US 54511-T15P	5.0	M 4.5	11	D-T08P/T15P	FG-15	HS 1655C	CAC 250C	HSD 1025C	HXK 7	–	–
FA029	US 54511-T15P	5.0	M 4.5	11	D-T08P/T15P	FG-15	HS 1655C	CAC 315C	HSD 1035C	HXK 7	CACP 3150C	RRH 34

AC001		KS 1230	K.FMH27
AC002		KS 1635	K.FMH32
AC003		KS 2040	K.FMH40

HNGX 09



	IC	D1	S
	(mm)	(mm)	(mm)
0906	16.500	4.90	6.35

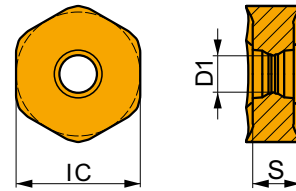

Suitability and starting values for cutting speed (vc), feed (f) and depth of cut (ap). Refer to our Machining Calculator app for further calculations.

Product	RE	P			M			K			N			S			H		
		vc	f	ap	vc	f	ap	vc	f	ap	vc	f	ap	vc	f	ap	vc	f	ap
	(mm)	(m/min)	(mm/tooth)	(mm)	(m/min)	(mm/tooth)	(mm)	(m/min)	(mm/tooth)	(mm)	(m/min)	(mm/tooth)	(mm)	(m/min)	(mm/tooth)	(mm)	(m/min)	(mm/tooth)	(mm)

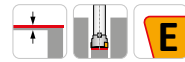
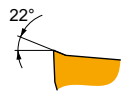

FF geometry with highly positive design for light machining.

HNGX 0906ANEN-FF	8215	–	■ 345	0.10	1.0	☑ 205	0.09	1.0	–	–	–	–	–	–	–	–	–	–	–
	M8330	–	■ 335	0.10	1.0	■ 200	0.09	1.0	–	–	–	–	–	–	–	–	–	–	–
	M9340	–	■ 405	0.10	1.0	■ 240	0.09	1.0	–	–	–	–	–	–	–	–	–	–	–

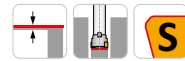
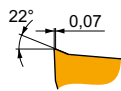

F geometry with highly positive design for light to medium machining.

HNGX 0906ANSN-F	8215	–	■ 300	0.12	2.1	☑ 180	0.11	2.1	–	–	–	–	–	–	–	–	–	–	–
	M6330	–	■ 255	0.12	2.1	■ 180	0.11	2.1	–	–	–	–	–	–	–	–	–	–	–
	M8310	–	■ 330	0.12	2.1	☑ 165	0.11	2.1	–	–	–	–	–	–	–	–	–	–	–
	M8330	–	■ 300	0.12	2.1	■ 180	0.11	2.1	–	–	–	–	–	–	–	–	–	–	–
	M8340	–	■ 270	0.12	2.1	■ 160	0.11	2.1	–	–	–	–	–	–	–	–	–	–	–



Suitability and starting values for cutting speed (vc), feed (f) and depth of cut (ap). Refer to our Machining Calculator app for further calculations.

Product	RE (mm)	P			M			K			N			S			H		
		vc (m/min)	f (mm/tooth)	ap (mm)	vc (m/min)	f (mm/tooth)	ap (mm)	vc (m/min)	f (mm/tooth)	ap (mm)	vc (m/min)	f (mm/tooth)	ap (mm)	vc (m/min)	f (mm/tooth)	ap (mm)	vc (m/min)	f (mm/tooth)	ap (mm)

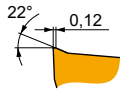

M geometry with highly positive design for medium machining.

HNGX 0906ANSN-M	8215	—	■	255	0.20	2.7	▣	150	0.18	2.7	■	240	0.20	2.7	—	—	—	—	—	—
	M5315	—	▣	340	0.20	2.7	—	—	—	—	■	320	0.20	2.7	—	—	—	—	—	—
	M6330	—	■	220	0.20	2.7	▣	155	0.18	2.7	—	—	—	—	—	—	—	—	—	—
	M8310	—	■	280	0.20	2.7	▣	140	0.18	2.7	■	265	0.20	2.7	—	—	—	—	—	—
	M8330	—	■	255	0.20	2.7	▣	150	0.18	2.7	■	240	0.20	2.7	—	—	—	—	—	—
	M8340	—	■	235	0.20	2.7	▣	140	0.18	2.7	▣	220	0.20	2.7	—	—	—	—	—	—
	M9315	—	■	340	0.20	2.7	—	—	—	—	■	320	0.20	2.7	—	—	—	—	—	—
	M9325	—	■	315	0.20	2.7	—	—	—	—	■	295	0.20	2.7	—	—	—	—	—	—
	M9340	—	■	290	0.20	2.7	▣	170	0.18	2.7	—	—	—	—	—	—	—	—	—	—

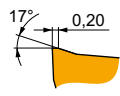

R geometry with positive design for medium to heavy machining.

HNGX 0906ANSN-R	8215	—	■	240	0.25	3.0	▣	140	0.25	3.0	■	225	0.25	3.0	—	—	—	—	▣	45	0.13	1.0
	M5315	—	▣	305	0.25	3.0	—	—	—	—	■	285	0.25	3.0	—	—	—	—	▣	60	0.13	1.0
	M8310	—	■	260	0.25	3.0	▣	130	0.25	3.0	■	245	0.25	3.0	—	—	—	—	▣	50	0.13	1.0
	M8330	—	■	240	0.25	3.0	▣	140	0.25	3.0	■	225	0.25	3.0	—	—	—	—	▣	45	0.13	1.0
	M8340	—	■	220	0.25	3.0	▣	130	0.25	3.0	▣	205	0.25	3.0	—	—	—	—	—	—	—	—
	M9315	—	■	310	0.25	3.0	—	—	—	—	■	290	0.25	3.0	—	—	—	—	▣	60	0.13	1.0
	M9325	—	■	295	0.25	3.0	—	—	—	—	■	280	0.25	3.0	—	—	—	—	▣	55	0.13	1.0

XNGX 09



	IC (mm)	D1 (mm)	S (mm)
0906	16.500	4.90	6.35

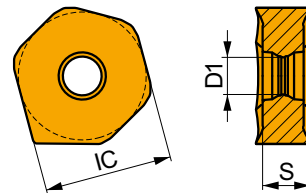

Suitability and starting values for cutting speed (vc), feed (f) and depth of cut (ap). Refer to our Machining Calculator app for further calculations.

Product	RE (mm)	P			M			K			N			S			H		
		vc (m/min)	f (mm/tooth)	ap (mm)	vc (m/min)	f (mm/tooth)	ap (mm)	vc (m/min)	f (mm/tooth)	ap (mm)	vc (m/min)	f (mm/tooth)	ap (mm)	vc (m/min)	f (mm/tooth)	ap (mm)	vc (m/min)	f (mm/tooth)	ap (mm)

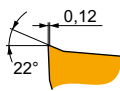

Wiper design for improved surface finish.

XNGX 0906ANSN	8215	—	■	245	0.20	2.7	▣	145	0.18	2.7	■	230	0.20	2.7	—	—	—	—	—	—
	M8330	—	■	245	0.20	2.7	▣	145	0.18	2.7	■	230	0.20	2.7	—	—	—	—	—	—



a_e / DC	5 %	10 %	15 %	20 %	25 %	30 %	40 %	50 %	60 %	70 %	75 %	80 %	90 %	100 %
	1.48	1.35	1.27	1.22	1.19	1.16	1.11	1.08	1.05	1.03	1.00	1.00	1.00	1.00
	2.20	1.60	1.35	1.20	1.10	0.95	0.85	0.75	0.85	0.95	1.00	1.00	1.00	1.00
	0.64	0.64	0.64	0.64	0.64	0.65	0.65	0.67	0.68	0.71	0.72	0.74	0.79	1.00

	HNGX 09-FF	HNGX 09-F	HNGX 09-M	HNGX 09-R	XNGX 09
	-	-	-	-	-
	1.50	1.17	1.17	1.17	7.53

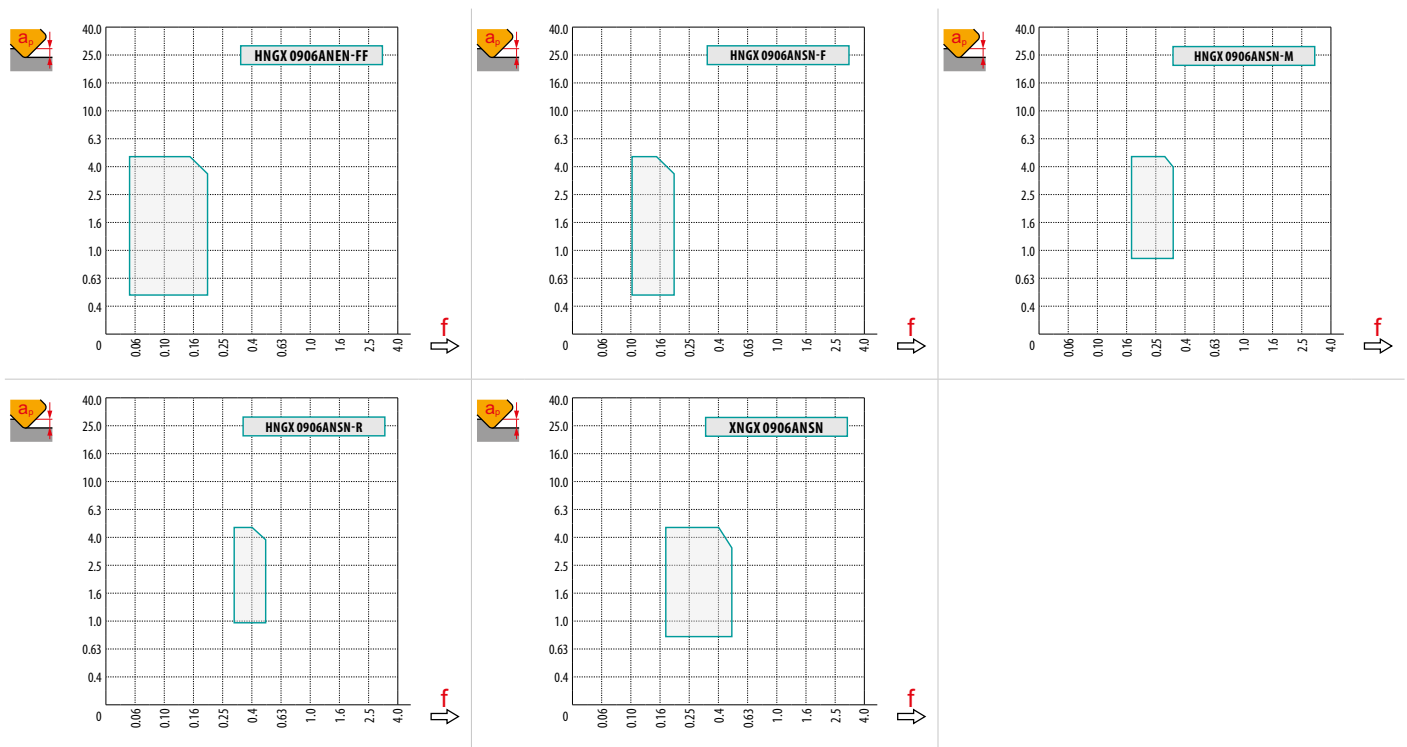

		f_{max}		RPMX	APMX/I	a_p
50	1.35	0.36	50	2.1	3.5/100	1.9
63	1.39	0.40	63	1.5	2.5/100	
80	1.44	0.45	80	1.1	1.8/100	
100	1.48	0.51	100	0.9	1.4/100	
125	1.53	0.57	125	0.7	1.1/100	
160	1.58	0.64	160	0.5	0.7/100	
200	1.63	0.72				
250	1.68	0.80				
315	1.74	0.90				



SPN13

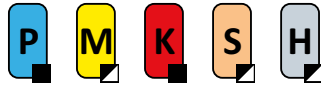

PRAMET



PENTA HD 57° Face Mill with Double Negative Design for Heavy Face Milling

Highly productive 57° face mill utilising double sided PN.. 13 and XN.. 13 style inserts with APMX of 10 mm. Suited for face milling. Arbor style only in range from Ø100 up to Ø315 mm. An insert seat protected with a shim. Body treated for longer tool life.

PENTA HD

KAPR	57°
APMX	10.0 mm

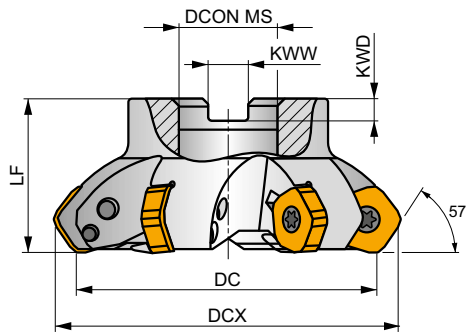
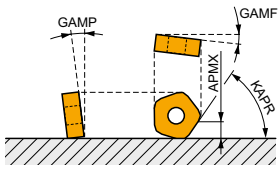

DC 100 – 125 mm

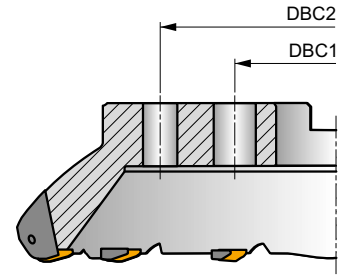

DC 160 – 315 mm

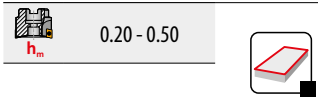
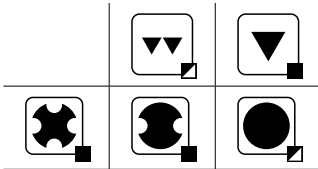

Product	DC	DCX	LF	DCON MS	DBC1	DBC2	KWW	KWD	GAMF	GAMP	Icons
	(mm)	(mm)	(mm)	(mm)	(mm)	(mm)	(mm)	(mm)	(°)	(°)	
100A05R-S57PN13	100	115.8	50	32	-	-	14.4	8	-8.2	-4	5, 3400, 1.22, GI261, FA081, AC002
125A06R-S57PN13	125	140.8	63	40	-	-	16.4	9	-7	-4	6, 3100, 2.34, GI261, FA081, AC003
160C08R-S57PN13	160	175.8	63	40	66.7	-	16.4	9	-6	-4	8, 2700, 3.58, GI261, FA081, -
200C10R-S57PN13	200	215.8	63	60	101.6	-	25.7	14	-5	-4	10, 2400, 9.17, GI261, FA081, -
250C12R-S57PN13	250	265.8	63	60	101.6	-	25.7	14	-5	-4	12, 2200, 15.39, GI261, FA081, -
315C14R-S57PN13	315	330.8	80	60	101.6	177.8	25.7	14	-5	-4	14, 1900, 29.17, GI261, FA081, -

GI261	PNMU 1308DN..	XNGX 1308DNSN	PNMQ 1308DN..
-------	---------------	---------------	---------------

FA081	SPN 13T3DN	US 64010-T15P	SDRT15P	US 68026-T30P	15.0	M 8	26	SDRT30P-T
-------	------------	---------------	---------	---------------	------	-----	----	-----------

AC002	KS 1635	K.FMH32
AC003	KS 2040	K.FMH40



PNMU 13



	BS	IC	D1	L	S
	(mm)	(mm)	(mm)	(mm)	(mm)
1308	3.00	24.400	10.00	13.00	7.94

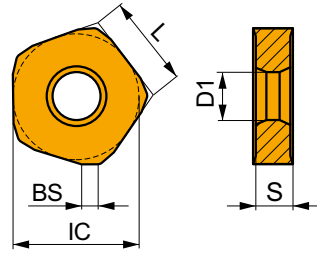

Suitability and starting values for cutting speed (vc), feed (f) and depth of cut (ap). Refer to our Machining Calculator app for further calculations.

Product	RE	P			M			K			N			S			H		
		vc	f	ap	vc	f	ap	vc	f	ap	vc	f	ap	vc	f	ap	vc	f	ap
	(mm)	(m/min)	(mm/tooth)	(mm)	(m/min)	(mm/tooth)	(mm)	(m/min)	(mm/tooth)	(mm)	(m/min)	(mm/tooth)	(mm)	(m/min)	(mm/tooth)	(mm)	(m/min)	(mm/tooth)	(mm)

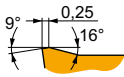

M geometry with positive design for rough machining.

PNMU 1308DNSR-M	8215	–	█	165	0.35	6.5	▣	95	0.32	6.5	█	155	0.35	6.5	–	–	–	▣	40	0.28	5.2	▣	30	0.18	2.0
	M8330	–	█	190	0.35	6.5	▣	110	0.32	6.5	█	180	0.35	6.5	–	–	–	▣	45	0.28	5.2	▣	35	0.18	2.0
	M8345	–	█	135	0.35	6.5	▣	80	0.32	6.5	–	–	–	–	–	–	▣	30	0.28	5.2	–	–	–	–	
	M9315	–	█	210	0.35	6.5	–	–	–	–	–	–	–	–	–	–	–	▣	–	–	–	▣	40	0.18	2.0
	M9340	–	█	170	0.35	6.5	▣	100	0.32	6.5	–	–	–	–	–	–	–	▣	40	0.28	5.2	–	–	–	–

PNMQ 13



	BS	IC	D1	L	S
	(mm)	(mm)	(mm)	(mm)	(mm)
1308	3.00	24.400	10.00	13.00	7.94

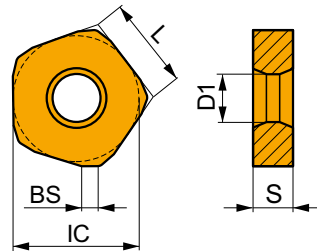

Suitability and starting values for cutting speed (vc), feed (f) and depth of cut (ap). Refer to our Machining Calculator app for further calculations.

Product	RE	P			M			K			N			S			H		
		vc	f	ap	vc	f	ap	vc	f	ap	vc	f	ap	vc	f	ap	vc	f	ap
	(mm)	(m/min)	(mm/tooth)	(mm)	(m/min)	(mm/tooth)	(mm)	(m/min)	(mm/tooth)	(mm)	(m/min)	(mm/tooth)	(mm)	(m/min)	(mm/tooth)	(mm)	(m/min)	(mm/tooth)	(mm)

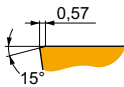

Zero rake angle design particularly suited to rough machining.

PNMQ 1308DNSN	M8330	–	▣	165	0.60	6.5	–	–	–	█	155	0.60	6.5	–	–	–	–	–	–	▣	30	0.30	2.0
	M8345	–	▣	120	0.60	6.5	–	–	–	–	–	–	–	–	–	–	–	–	–	–	–	–	–



XNGX 13

	IC (mm)	D1 (mm)	S (mm)
1308	24.180	10.00	7.94

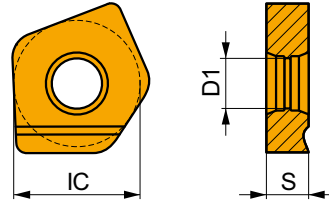

Suitability and starting values for cutting speed (vc), feed (f) and depth of cut (ap). Refer to our Machining Calculator app for further calculations.

Product	RE (mm)	P			M			K			N			S			H		
		vc (m/min)	f (mm/tooth)	ap (mm)	vc (m/min)	f (mm/tooth)	ap (mm)	vc (m/min)	f (mm/tooth)	ap (mm)	vc (m/min)	f (mm/tooth)	ap (mm)	vc (m/min)	f (mm/tooth)	ap (mm)	vc (m/min)	f (mm/tooth)	ap (mm)



Wiper design for improved surface finish.

XNGX 1308DNSN	M8330	-	■	245	0.45	2.5	-	-	-	■	230	0.45	2.5	-	-	-	-	-	-	-	-	-
----------------------	--------------	---	---	-----	------	-----	---	---	---	---	-----	------	-----	---	---	---	---	---	---	---	---	---



a_e / DC	5 %	10 %	15 %	20 %	25 %	30 %	40 %	50 %	60 %	70 %	75 %	80 %	90 %	100 %
	1.48	1.35	1.27	1.22	1.19	1.16	1.11	1.08	1.05	1.03	1.00	1.00	1.00	1.00
	2.20	1.60	1.35	1.20	1.10	0.95	0.85	0.75	0.85	0.95	1.00	1.00	1.00	1.00
	0.64	0.64	0.64	0.64	0.64	0.65	0.65	0.67	0.68	0.71	0.72	0.74	0.79	1.00

	PNMU 13-M	PNMQ 13	XNGX 13
	-	-	-
	3.00	3.00	12.71

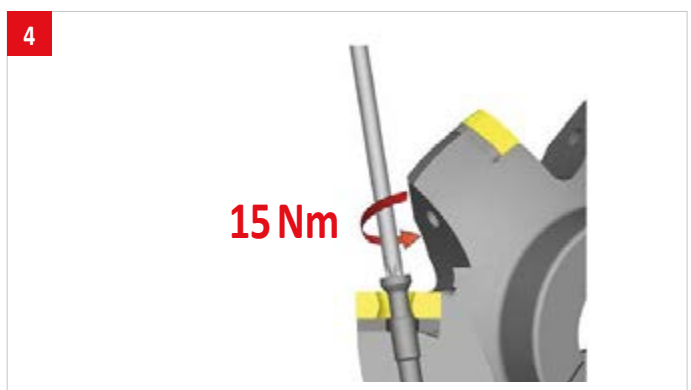
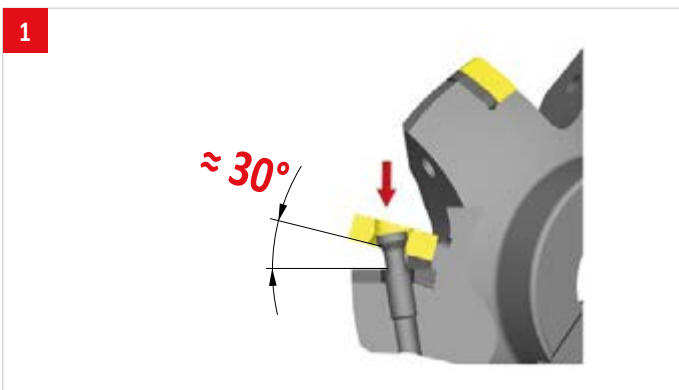
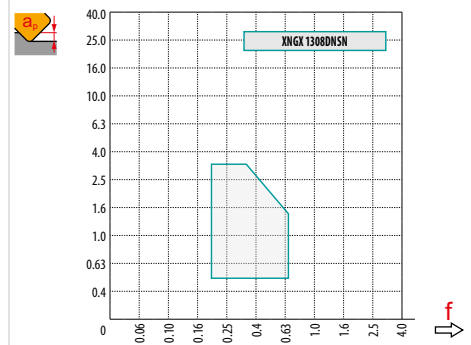
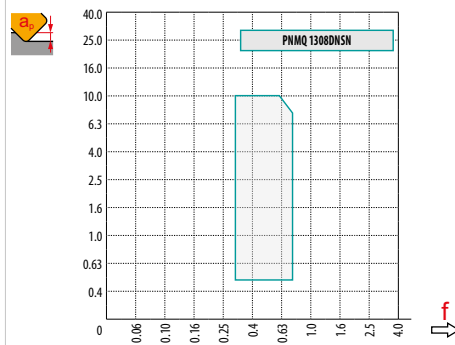
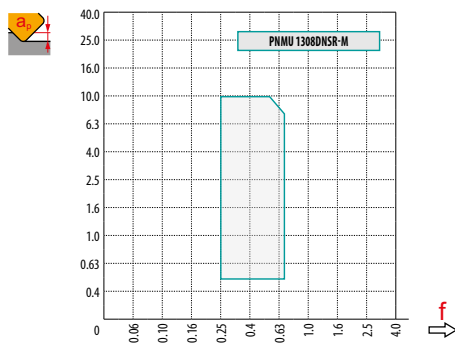



FSB22X

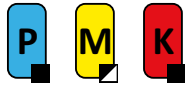

PRAMET



ROUGH SB 60° Face Mill with Positive Design for Heavy Face Milling

Highly productive 60° face mill utilising single sided SB.. 22 style inserts with APMX of 15 mm. Optimized for heavy face milling with smooth cutting action. Differential tooth pitch. Arbor style only in range from Ø125 up to Ø315 mm. Body treated for longer tool life.

ROUGH SB

KAPR	60°
APMX	15.0 mm

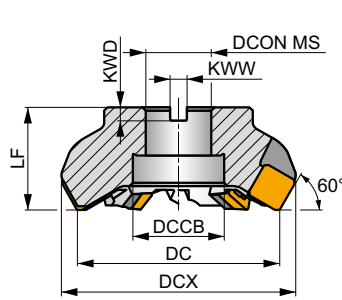
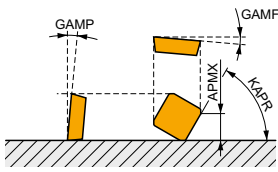

DC 125 mm

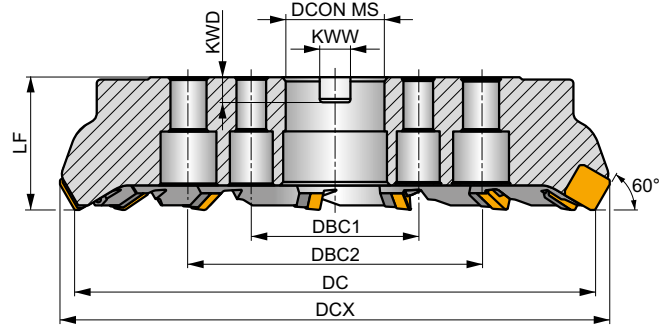

DC 160 – 315 mm

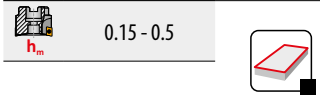
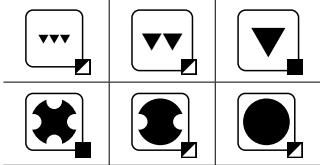

0.15 - 0.5

Product	DC	DCX	LF	DCON MS	DCCB	DBC1	DBC2	KWW	KWD	GAMF	GAMP	max.	kg	GI144	FA111	AC003
	(mm)	(mm)	(mm)	(mm)	(mm)	(mm)	(mm)	(mm)	(mm)	(°)	(°)					
125B07R-F60SB22X	125	144.4	63	40	56	-	-	16.4	9	-9	9	7	3.64	GI144	FA111	AC003
160C08R-F60SB22X	160	178.7	63	40	-	66.7	-	16.4	9	-9	9	8	6.30	GI144	FA114	-
200C08R-F60SB22X	200	217.9	63	60	-	101.6	-	25.7	14	-9	9	8	10.59	GI144	FA115	-
200C10R-F60SB22X	200	217.9	63	60	-	101.6	-	25.7	14	-9	9	10	9.81	GI144	FA115	-
250C09R-F60SB22X	250	267.4	63	60	-	101.6	-	25.7	14	-9	9	9	17.54	GI144	FA115	-
250C12R-F60SB22X	250	267.4	63	60	-	101.6	-	25.7	14	-9	9	12	16.50	GI144	FA115	-
315C11R-F60SB22X	315	331.8	80	60	-	101.6	177.8	25.7	14	-9	9	11	36.00	GI144	FA115	-
315C14R-F60SB22X	315	331.8	80	60	-	101.6	177.8	25.7	14	-9	9	14	36.50	GI144	FA115	-

GI144	SBKX 2207DZ..	SBMR 2207DZ..
-------	---------------	---------------

FA111	LNX 220616	US 6013-T20P	SDRT20P-T	KU SBMR 2207	DS 01Z	KL 04	-
FA114	LNX 220616	US 6013-T20P	SDRT20P-T	KU SBMR 2207	DS 01Z	KL 04	HS 1240
FA115	LNX 220616	US 6013-T20P	SDRT20P-T	KU SBMR 2207	DS 01Z	KL 04	HS 1655

AC003	KS 2040	K.FMH40
-------	---------	---------



SBMR 22

PRAMET

	IC (mm)	M (mm)	S (mm)	BS (mm)
2207	22.000	3	8.00	1.99

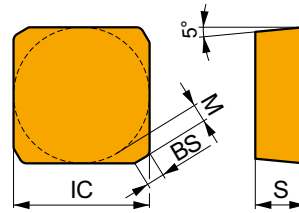

Suitability and starting values for cutting speed (vc), feed (f) and depth of cut (ap). Refer to our Machining Calculator app for further calculations.

Product	RE (mm)	P			M			K			N			S			H		
		vc (m/min)	f (mm/tooth)	ap (mm)	vc (m/min)	f (mm/tooth)	ap (mm)	vc (m/min)	f (mm/tooth)	ap (mm)	vc (m/min)	f (mm/tooth)	ap (mm)	vc (m/min)	f (mm/tooth)	ap (mm)	vc (m/min)	f (mm/tooth)	ap (mm)

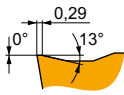

Stable design for heavy machining.

SBMR 2207DZSR	M8326	-	140	0.38	8.5	-	-	-	130	0.38	8.5	-	-	-	-	-	-	-	-
	M8346	-	120	0.38	8.5	70	0.38	8.5	-	-	-	-	-	-	-	-	-	-	

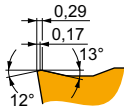

R geometry with stable design for heavy machining.

SBMR 2207DZSR-R	M5326	-	160	0.44	9.8	-	-	-	150	0.44	9.8	-	-	-	-	-	-	-
	M8326	-	135	0.44	9.8	-	-	-	125	0.44	9.8	-	-	-	-	-	-	-
	M8346	-	115	0.44	9.8	65	0.40	9.8	-	-	-	-	-	-	-	-	-	

SBKX 22

PRAMET

	IC (mm)	M (mm)	S (mm)	BS (mm)
2207	22.000	3	8.00	11.84

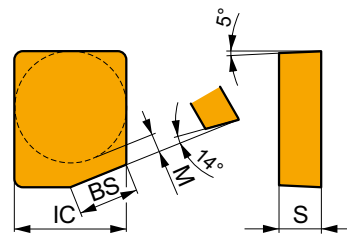

Suitability and starting values for cutting speed (vc), feed (f) and depth of cut (ap). Refer to our Machining Calculator app for further calculations.

Product	RE (mm)	P			M			K			N			S			H		
		vc (m/min)	f (mm/tooth)	ap (mm)	vc (m/min)	f (mm/tooth)	ap (mm)	vc (m/min)	f (mm/tooth)	ap (mm)	vc (m/min)	f (mm/tooth)	ap (mm)	vc (m/min)	f (mm/tooth)	ap (mm)	vc (m/min)	f (mm/tooth)	ap (mm)



Zero rake wiper design for improved surface finish.

SBKX 2207DZER	M8326	-	100	0.60	8.5	-	-	-	95	0.60	8.5	-	-	-	-	-	-	-
----------------------	--------------	---	-----	------	-----	---	---	---	----	------	-----	---	---	---	---	---	---	---



a_e / DC	5 %	10 %	15 %	20 %	25 %	30 %	40 %	50 %	60 %	70 %	75 %	80 %	90 %	100 %
	1.48	1.35	1.27	1.22	1.19	1.16	1.11	1.08	1.05	1.03	1.00	1.00	1.00	1.00
	2.20	1.60	1.35	1.20	1.10	0.95	0.85	0.75	0.85	0.95	1.00	1.00	1.00	1.00
	0.64	0.64	0.64	0.64	0.64	0.65	0.65	0.67	0.68	0.71	0.72	0.74	0.79	1.00

	SBMR 22	SBMR 22-R	SBKX 22
	-	-	-
	1.99	1.99	11.84

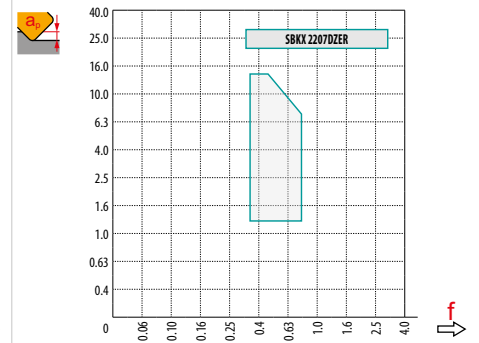
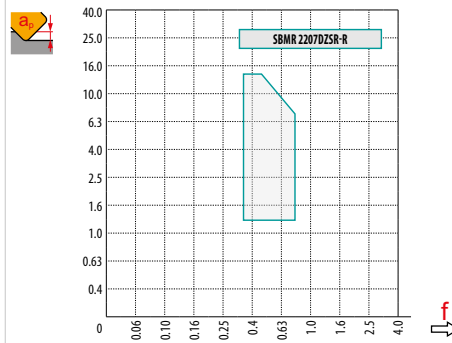
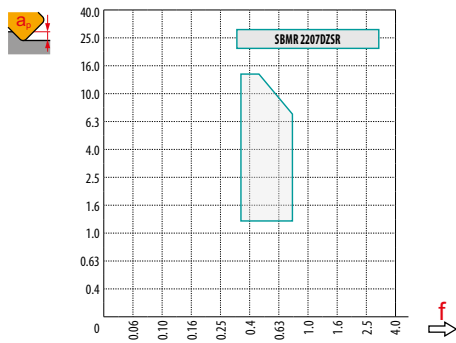



























INDEXABLE MILLS – NAVIGATOR

SQUARE SHOULDER MILLING



	SAD11E		SAD16E		SLN12		SLN16																	
	90°		90°		90°		90°																	
	APMX (mm)	9.0	APMX (mm)	13.0	APMX (mm)	9.0	APMX (mm)	13.0																
	DC (mm)	16 – 125	DC (mm)	25 – 175	DC (mm)	25 – 125	DC (mm)	63 – 175																
Cylindrical shank		DC = 16 – 35 (mm)		DC = 25 – 32 (mm)		DC = 25 – 32 (mm)																		
Weldon		DC = 16 – 32 (mm)		DC = 25 – 40 (mm)		DC = 25 – 40 (mm)																		
Modular		DC = 16 – 40 (mm)		DC = 32 – 40 (mm)		DC = 25 – 40 (mm)																		
Shell mill		DC = 40 – 125 (mm)		DC = 40 – 175 (mm)		DC = 40 – 125 (mm)																		
Page	📖 317		📖 325		📖 333		📖 339																	
ISO	P	M	K	N	S	H	P	M	K	N	S	H	P	M	K	N	P	K	N	H				
Insert shape																								
Inserts	AD.X 11T3		AD.X 1606		LNG. 1205		LN.U 1607																	
No. of cutting edges	2		2		4		4																	
Shallow shoulder milling 	■		■		■		■																	
Helical interpolation 	■		■		▣																			
Shallow slot milling 	■		■		■		■																	
Plunge milling 	■		■		■		■																	
Progressive plunging 	■		■		▣																			
Ramping 	■		■		▣																			
Face milling 	▣		▣		▣																			
Shape surfaces milling (copy milling) 	■		■		▣		▣																	

■ Primary use ▣ Possible use



SAD11E

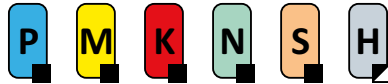

PRAMET

S



FORCE AD11 Square Shoulder Mill with Internal Coolant

90° end and shell mills utilising positive AD.. 11 style insert with APMX of 9 mm. Suitable for face, shoulder, slot, helical, trochoidal, ramping and plunge milling. Available in cylindrical, weldon, morse taper, modular and arbor (with differential tooth pitch) style, in Ø16 up to Ø125 mm. Body treated for longer tool life.

FORCE AD

KAPR	90°
APMX	9.0 mm

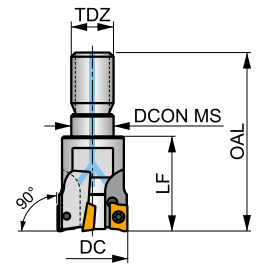
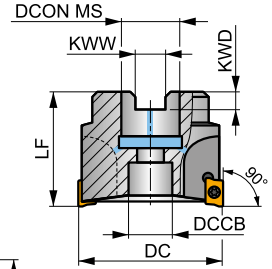
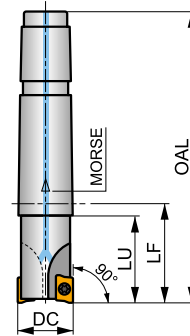
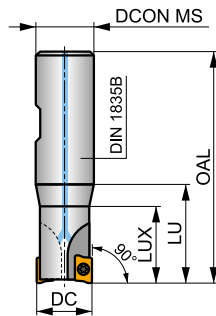
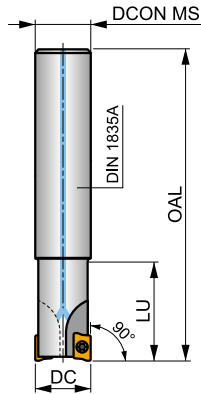
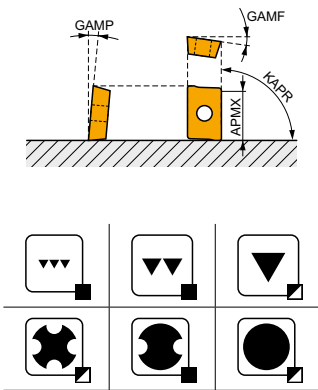

	0.06 - 0.13
	0.08 - 0.16

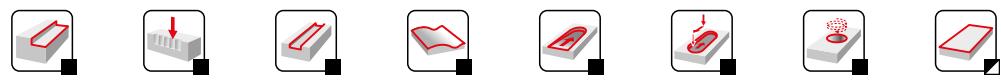

Product	DC	OAL	DCON MS	DCCB	LU	LUX	LF	TDZ	CZC MS	KWW	KWD	GAMF	GAMP	max.		kg	G1169	SQ025		
	(mm)	(mm)	(mm)	(mm)	(mm)	(mm)	(mm)	(mm)	(mm)	(mm)	(°)	(°)								
16A2R024A14-SAD11E-C	16	160	14	-	24	-	-	-	-	-	-	-12.8	4	2	-	30100	✓	0.21	GI169 SQ025	-
16A2R024A16-SAD11E-C	16	135	16	-	24	-	-	-	-	-	-	-12.8	4	2	-	30100	✓	0.19	GI169 SQ025	-
16A2R050A16-SAD11E-C	16	135	16	-	50	-	-	-	-	-	-	-12.8	4	2	-	30100	✓	0.20	GI169 SQ025	-
18A2R029A20-SAD11E-C	18	150	20	-	29	-	-	-	-	-	-	-12	4.5	2	-	28400	✓	0.35	GI169 SQ025	-
20A2R029A20-SAD11E-C	20	150	20	-	29	-	-	-	-	-	-	-11.5	5	2	-	27000	✓	0.33	GI169 SQ020	-
20A2R070A20-SAD11E-C	20	150	20	-	70	-	-	-	-	-	-	-11.5	5	2	-	27000	✓	0.32	GI169 SQ020	-
20A3R029A18-SAD11E-C	20	200	18	-	29	-	-	-	-	-	-	-11.5	5	3	-	27000	✓	0.38	GI169 SQ025	-
20A3R029A20-SAD11E-C	20	150	20	-	29	-	-	-	-	-	-	-11.5	5	3	-	27000	✓	0.33	GI169 SQ025	-
22A3R029A20-SAD11E-C	22	200	20	-	29	-	-	-	-	-	-	-11.5	5	3	-	25600	✓	0.49	GI169 SQ025	-
25A3R034A25-SAD11E-C	25	170	25	-	34	-	-	-	-	-	-	-10.2	5	3	-	24100	✓	0.42	GI169 SQ020	-
25A3R080A25-SAD11E-C	25	170	25	-	80	-	-	-	-	-	-	-10.2	5	3	-	24100	✓	0.55	GI169 SQ020	-
25A4R034A25-SAD11E-C	25	170	25	-	34	-	-	-	-	-	-	-10.2	5	4	-	24100	✓	0.42	GI169 SQ025	-
25A4R040A25-SAD11E-C	25	250	25	-	40	-	-	-	-	-	-	-10.2	5	4	-	24100	✓	0.86	GI169 SQ025	-
30A3R080A32-SAD11E-C	30	200	32	-	80	-	-	-	-	-	-	-9.3	7	3	-	22000	✓	1.02	GI169 SQ020	-
32A3R090A32-SAD11E-C	32	195	32	-	90	-	-	-	-	-	-	-9	5	3	-	21300	✓	1.01	GI169 SQ020	-
32A5R034A32-SAD11E-C	32	195	32	-	34	-	-	-	-	-	-	-9	8	5	-	21300	✓	1.03	GI169 SQ025	-
35A5R025A32-SAD11E-C	35	200	32	-	25	-	-	-	-	-	-	-9	8	5	-	20300	✓	1.16	GI169 SQ020	-
16A2R027B16-SAD11E-C	16	75	16	-	27	-	-	-	-	-	-	-12.8	4	2	-	30100	✓	0.09	GI169 SQ025	-
20A2R032B20-SAD11E-C	20	82	20	-	32	-	-	-	-	-	-	-11.5	5	2	-	27000	✓	0.13	GI169 SQ020	-
20A3R032B20-SAD11E-C	20	82	20	-	32	-	-	-	-	-	-	-11.5	5	3	-	27000	✓	0.13	GI169 SQ025	-
25A3R042B25-SAD11E-C	25	98	25	-	42	-	-	-	-	-	-	-10.2	5	3	-	24100	✓	0.29	GI169 SQ020	-
25A4R042B25-SAD11E-C	25	98	25	-	42	-	-	-	-	-	-	-10.2	5	4	-	24100	✓	0.31	GI169 SQ025	-
32A4R042B32-SAD11E-C	32	102	32	-	42	-	-	-	-	-	-	-9	8	4	-	21300	✓	0.27	GI169 SQ020	-
32A5R042B32-SAD11E-C	32	102	32	-	42	-	-	-	-	-	-	-9	8	5	-	21300	✓	0.52	GI169 SQ025	-
16A2R030E02-SAD11E-C	16	94	-	-	25	-	30	-	2	-	-	-12.8	4	2	-	30100	✓	0.15	GI169 SQ025	-
20A3R035E03-SAD11E-C	20	116	-	-	30	-	35	-	3	-	-	-11.5	5	3	-	27000	✓	0.28	GI169 SQ025	-
25A4R043E03-SAD11E-C	25	124	-	-	38	-	43	-	3	-	-	-10.2	5	4	-	24100	✓	0.32	GI169 SQ025	-



Product	DC	OAL	DCON MS	DCCB	LU	LUX	LF	TDZ	CZC MS	KWW	KWD	GAMF	GAMP								
	(mm)	(mm)	(mm)	(mm)	(mm)	(mm)	(mm)			(mm)	(mm)	(°)	(°)								
16A2R024M08-SAD11E-C	16	38	8.5	-	-	-	24	M8	-	-	-	-12.8	4	2	-	-	✓	0.04	GI169	SQ025	-
20A2R026M10-SAD11E-C	20	45	11	-	-	-	26	M10	-	-	-	-11.5	5	2	-	-	✓	0.09	GI169	SQ020	-
20A3R026M10-SAD11E-C	20	45	10.5	-	-	-	26	M10	-	-	-	-11.5	5	3	-	-	✓	0.06	GI169	SQ025	-
25A3R033M12-SAD11E-C	25	55	12.5	-	-	-	33	M12	-	-	-	-10.2	5	3	-	-	✓	0.15	GI169	SQ020	-
25A4R033M12-SAD11E-C	25	55	12.5	-	-	-	33	M12	-	-	-	-10.2	5	4	-	-	✓	0.09	GI169	SQ025	-
32A4R043M16-SAD11E-C	32	66	17	-	-	-	43	M16	-	-	-	-9	8	4	-	-	✓	0.21	GI169	SQ020	-
32A5R043M16-SAD11E-C	32	66	17	-	-	-	43	M16	-	-	-	-9	8	5	-	-	✓	0.19	GI169	SQ025	-
40A4R043M16-SAD11E-C	40	66	17	-	-	-	43	M16	-	-	-	-8.1	11	4	-	-	✓	0.27	GI169	SQ020	-
40A6R043M16-SAD11E-C	40	66	17	-	-	-	43	M16	-	-	-	-8.1	11	6	-	-	✓	0.21	GI169	SQ020	-
40A04R-S90AD11E-C	40	-	16	14	-	-	40	-	-	8.4	5.6	-8.1	11	4	✓	19100	✓	0.16	GI169	SQ022	-
40A05R-S90AD11E-C	40	-	16	14	-	-	40	-	-	8.4	5.6	-8.1	11	5	✓	19000	✓	0.32	GI169	SQ022	-
40A06R-S90AD11E-C	40	-	16	14	-	-	40	-	-	8.4	5.6	-8.1	11	6	✓	19100	✓	0.16	GI169	SQ022	-
50A05R-S90AD11E-C	50	-	22	18	-	-	40	-	-	10.4	6.3	-7.2	12	5	✓	17000	✓	0.31	GI169	SQ023	-
50A07R-S90AD11E-C	50	-	22	18	-	-	40	-	-	10.4	6.3	-7.2	12	7	✓	17000	✓	0.45	GI169	SQ023	-
63A06R-S90AD11E-C	63	-	22	18	-	-	40	-	-	10.4	6.3	-6.5	12	6	✓	15200	✓	0.54	GI169	SQ023	-
63A09R-S90AD11E-C	63	-	22	18	-	-	40	-	-	10.4	6.3	-6.5	12	9	✓	15200	✓	0.63	GI169	SQ023	-
80A10R-S90AD11E-C	80	-	27	38	-	-	50	-	-	12.4	7	-6	12	10	✓	13500	✓	1.05	GI169	SQ021	AC001
100A11R-S90AD11E-C	100	-	32	45	-	-	50	-	-	14.4	8	-5.5	12	11	✓	12100	✓	1.89	GI169	SQ021	AC002
125A12R-S90AD11E-C	125	-	40	56	-	-	63	-	-	16.4	9	-5.2	12	12	✓	10800	✓	2.97	GI169	SQ021	AC003

GI169	ADMX 11T3..	ADEX 11T3..

SQ020	US 62506-T07P	1.2	M 2.5	6	-	-	-	Flag T07P	-
SQ021	US 62506-T07P	1.2	M 2.5	6	D-T07P/T09P	FG-15	-	-	-
SQ022	US 62506-T07P	1.2	M 2.5	6	D-T07P/T09P	FG-15	-	-	HS 0830C
SQ023	US 62506-T07P	1.2	M 2.5	6	D-T07P/T09P	FG-15	-	-	HS 1030C
SQ025	US 62505-T07P	1.2	M 2.5	5	-	-	-	Flag T07P	-

AC001		KS 1230	K.FMH27
AC002		KS 1635	K.FMH32
AC003		KS 2040	K.FMH40



ADMX 11



	W1	D1	L	S
	(mm)	(mm)	(mm)	(mm)
11T3	6.530	2.90	11.00	3.97

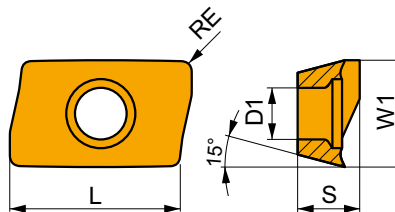

Suitability and starting values for cutting speed (vc), feed (f) and depth of cut (ap). Refer to our Machining Calculator app for further calculations.

Product	RE	P			M			K			N			S			H		
		vc	f	ap	vc	f	ap	vc	f	ap	vc	f	ap	vc	f	ap	vc	f	ap
	(mm)	(m/min)	(mm/tooth)	(mm)	(m/min)	(mm/tooth)	(mm)	(m/min)	(mm/tooth)	(mm)	(m/min)	(mm/tooth)	(mm)	(m/min)	(mm/tooth)	(mm)	(m/min)	(mm/tooth)	(mm)

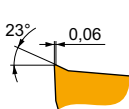

F geometry with very sharp positive design for light machining.

ADMX 11T304SR-F	8215	0.4	245	0.10	2.0	145	0.09	2.0	230	0.10	2.0	735	0.12	2.0	60	0.08	1.6	-	-	-
	M8330	0.4	240	0.10	2.0	140	0.09	2.0	225	0.10	2.0	720	0.12	2.0	60	0.08	1.6	-	-	-
	M8340	0.4	220	0.10	2.0	130	0.09	2.0	205	0.10	2.0	-	-	-	55	0.08	1.6	-	-	-
	M9340	0.4	285	0.10	2.0	170	0.09	2.0	-	-	-	-	-	-	70	0.08	1.6	-	-	-
ADMX 11T308SR-F	8215	0.8	290	0.10	2.0	170	0.09	2.0	275	0.10	2.0	870	0.12	2.0	70	0.08	1.6	-	-	-
	M8330	0.8	285	0.10	2.0	170	0.09	2.0	270	0.10	2.0	855	0.12	2.0	70	0.08	1.6	-	-	-
	M8340	0.8	260	0.10	2.0	155	0.09	2.0	245	0.10	2.0	-	-	-	65	0.08	1.6	-	-	-
	M9340	0.8	340	0.10	2.0	200	0.09	2.0	-	-	-	-	-	-	85	0.08	1.6	-	-	-

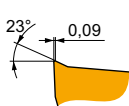

M geometry with positive design for light to medium machining.

ADMX 11T302SR-M	M8330	0.2	190	0.15	4.0	110	0.14	4.0	180	0.15	4.0	-	-	-	45	0.12	3.2	-	-	-	
	M8340	0.2	170	0.15	4.0	100	0.14	4.0	160	0.15	4.0	-	-	-	40	0.12	3.2	-	-	-	
ADMX 11T304SR-M	8215	0.4	205	0.15	4.0	120	0.14	4.0	190	0.15	4.0	-	-	-	50	0.12	3.2	-	-	-	
	M8310	0.4	220	0.15	4.0	110	0.14	4.0	205	0.15	4.0	-	-	-	-	-	-	-	-	-	
	M8330	0.4	205	0.15	4.0	120	0.14	4.0	190	0.15	4.0	-	-	-	50	0.12	3.2	-	-	-	
	M8340	0.4	185	0.15	4.0	110	0.14	4.0	175	0.15	4.0	-	-	-	45	0.12	3.2	-	-	-	
	M9325	0.4	255	0.15	4.0	-	-	-	240	0.15	4.0	-	-	-	-	-	-	-	-	-	-
	M9340	0.4	235	0.15	4.0	140	0.14	4.0	-	-	-	-	-	-	55	0.12	3.2	-	-	-	
ADMX 11T308SR-M	8215	0.8	245	0.15	4.0	145	0.14	4.0	230	0.15	4.0	-	-	-	60	0.12	3.2	-	-	-	
	M5315	0.8	335	0.15	4.0	-	-	-	315	0.15	4.0	-	-	-	-	-	-	-	-	-	
	M8310	0.8	265	0.15	4.0	135	0.14	4.0	250	0.15	4.0	-	-	-	-	-	-	-	-	-	
	M8330	0.8	245	0.15	4.0	145	0.14	4.0	230	0.15	4.0	-	-	-	60	0.12	3.2	-	-	-	
	M8340	0.8	220	0.15	4.0	130	0.14	4.0	205	0.15	4.0	-	-	-	55	0.12	3.2	-	-	-	
	M9315	0.8	330	0.15	4.0	-	-	-	310	0.15	4.0	-	-	-	-	-	-	-	-	-	
	M9325	0.8	305	0.15	4.0	-	-	-	285	0.15	4.0	-	-	-	-	-	-	-	-	-	
	M9340	0.8	275	0.15	4.0	165	0.14	4.0	-	-	-	-	-	-	65	0.12	3.2	-	-	-	
ADMX 11T310SR-M	M8330	1.0	255	0.15	4.0	150	0.14	4.0	240	0.15	4.0	-	-	-	60	0.12	3.2	-	-	-	
	M8340	1.0	230	0.15	4.0	135	0.14	4.0	215	0.15	4.0	-	-	-	55	0.12	3.2	-	-	-	
ADMX 11T312SR-M	8215	1.2	255	0.15	4.0	150	0.14	4.0	240	0.15	4.0	-	-	-	60	0.12	3.2	-	-	-	
	M8330	1.2	255	0.15	4.0	150	0.14	4.0	240	0.15	4.0	-	-	-	60	0.12	3.2	-	-	-	
	M8340	1.2	230	0.15	4.0	135	0.14	4.0	215	0.15	4.0	-	-	-	55	0.12	3.2	-	-	-	
ADMX 11T316SR-M	8215	1.6	270	0.15	4.0	160	0.14	4.0	255	0.15	4.0	-	-	-	65	0.12	3.2	-	-	-	
	M6330	1.6	230	0.15	4.0	165	0.14	4.0	-	-	-	-	-	65	0.12	3.2	-	-	-		
	M8310	1.6	295	0.15	4.0	150	0.14	4.0	280	0.15	4.0	-	-	-	-	-	-	-	-		
	M8330	1.6	270	0.15	4.0	160	0.14	4.0	255	0.15	4.0	-	-	-	65	0.12	3.2	-	-	-	
	M8340	1.6	240	0.15	4.0	140	0.14	4.0	225	0.15	4.0	-	-	-	60	0.12	3.2	-	-	-	
ADMX 11T320SR-M	M6330	2.0	240	0.15	4.0	170	0.14	4.0	-	-	-	-	-	70	0.12	3.2	-	-	-		
	M8330	2.0	280	0.15	4.0	165	0.14	4.0	265	0.15	4.0	-	-	-	70	0.12	3.2	-	-	-	
	M8340	2.0	255	0.15	4.0	150	0.14	4.0	240	0.15	4.0	-	-	-	60	0.12	3.2	-	-	-	



Suitability and starting values for cutting speed (vc), feed (f) and depth of cut (ap). Refer to our Machining Calculator app for further calculations.

Product	RE (mm)	P			M			K			N			S			H		
		vc (m/min)	f (mm/tooth)	ap (mm)	vc (m/min)	f (mm/tooth)	ap (mm)	vc (m/min)	f (mm/tooth)	ap (mm)	vc (m/min)	f (mm/tooth)	ap (mm)	vc (m/min)	f (mm/tooth)	ap (mm)	vc (m/min)	f (mm/tooth)	ap (mm)

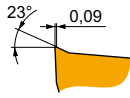

M geometry with positive design for light to medium machining.

ADMX 11T325SR-M	M6330	2.5	240	0.15	4.0	170	0.14	4.0	–	–	–	–	–	–	70	0.12	3.2	–	–	–
	M8340	2.5	255	0.15	4.0	150	0.14	4.0	240	0.15	4.0	–	–	–	60	0.12	3.2	–	–	–
ADMX 11T330SR-M	M6330	3.0	240	0.15	4.0	170	0.14	4.0	–	–	–	–	–	70	0.12	3.2	–	–	–	
	M8330	3.0	280	0.15	4.0	165	0.14	4.0	265	0.15	4.0	–	–	70	0.12	3.2	–	–	–	
	M8340	3.0	255	0.15	4.0	150	0.14	4.0	240	0.15	4.0	–	–	60	0.12	3.2	–	–	–	

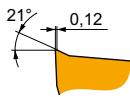
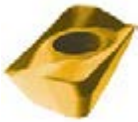

R geometry with positive design for machining conditions in less stable conditions.

ADMX 11T308PR-R	8215	0.8	230	0.18	4.0	135	0.16	4.0	215	0.18	4.0	–	–	–	55	0.16	3.2	45	0.12	0.7
	M5315	0.8	310	0.18	4.0	–	–	–	290	0.18	4.0	–	–	–	–	–	–	60	0.13	0.7
	M8310	0.8	250	0.18	4.0	125	0.16	4.0	235	0.18	4.0	–	–	–	–	–	–	50	0.12	0.7
	M8330	0.8	230	0.18	4.0	135	0.16	4.0	215	0.18	4.0	–	–	–	55	0.16	3.2	45	0.12	0.7
	M8340	0.8	210	0.18	4.0	125	0.16	4.0	195	0.18	4.0	–	–	–	50	0.16	3.2	–	–	–
	M9315	0.8	310	0.18	4.0	–	–	–	290	0.18	4.0	–	–	–	–	–	–	60	0.13	0.7
ADMX 11T316PR-R	M9325	0.8	290	0.18	4.0	–	–	–	275	0.18	4.0	–	–	–	–	–	–	55	0.13	0.7
	8215	1.6	255	0.18	4.0	150	0.16	4.0	240	0.18	4.0	–	–	–	60	0.16	3.2	50	0.12	0.7
	M8330	1.6	255	0.18	4.0	150	0.16	4.0	240	0.18	4.0	–	–	–	60	0.16	3.2	50	0.12	0.7
	M9325	1.6	320	0.18	4.0	–	–	–	300	0.18	4.0	–	–	–	–	–	–	60	0.12	0.7

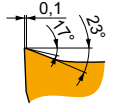

MF geometry with highly positive design for light to finish machining.

ADMX 11T304SR-MF	M6330	0.4	215	0.08	2.5	150	0.07	2.5	–	–	–	–	–	–	60	0.06	2.0	–	–	–
	M8340	0.4	220	0.08	2.5	130	0.07	2.5	–	–	–	–	–	–	55	0.06	2.0	–	–	–
ADMX 11T308SR-MF	M6330	0.8	255	0.08	2.5	180	0.07	2.5	–	–	–	–	–	–	75	0.06	2.0	–	–	–
	M8340	0.8	265	0.08	2.5	155	0.07	2.5	–	–	–	–	–	–	65	0.06	2.0	–	–	–

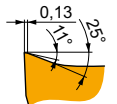

MM geometry with highly positive design for light to medium machining.

ADMX 11T304SR-MM	M6330	0.4	185	0.14	2.5	130	0.13	2.5	–	–	–	–	–	–	55	0.11	2.0	–	–	–
	M8340	0.4	195	0.14	2.5	115	0.13	2.5	–	–	–	–	–	–	45	0.11	2.0	–	–	–
ADMX 11T308SR-MM	M6330	0.8	225	0.14	2.5	155	0.13	2.5	–	–	–	–	–	–	65	0.11	2.0	–	–	–
	M8340	0.8	235	0.14	2.5	140	0.13	2.5	–	–	–	–	–	–	55	0.11	2.0	–	–	–
	M8345	0.8	190	0.14	2.5	110	0.13	2.5	–	–	–	–	–	–	45	0.11	2.0	–	–	–
	M9340	0.8	300	0.14	2.5	180	0.13	2.5	–	–	–	–	–	–	75	0.11	2.0	–	–	–
ADMX 11T312SR-MM	M6330	1.2	235	0.14	2.5	165	0.13	2.5	–	–	–	–	–	–	70	0.11	2.0	–	–	–
	M8340	1.2	245	0.14	2.5	145	0.13	2.5	–	–	–	–	–	–	60	0.11	2.0	–	–	–



ADEX 11-HF

	W1	D1	L	S
	(mm)	(mm)	(mm)	(mm)
11T3	6.450	2.90	10.67	3.82

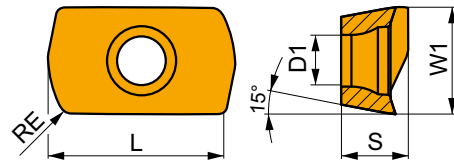

Suitability and starting values for cutting speed (vc), feed (f) and depth of cut (ap). Refer to our Machining Calculator app for further calculations.

Product	RE (mm)	P			M			K			N			S			H		
		vc (m/min)	f (mm/tooth)	ap (mm)	vc (m/min)	f (mm/tooth)	ap (mm)	vc (m/min)	f (mm/tooth)	ap (mm)	vc (m/min)	f (mm/tooth)	ap (mm)	vc (m/min)	f (mm/tooth)	ap (mm)			

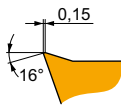

HF geometry with highly positive design for high feed machining.

Product	RE	vc	f	ap	vc	f	ap	vc	f	ap	vc	f	ap	vc	f	ap
ADEX 11T308SR-HF	0.8	215	0.68	0.4	125	0.61	0.4	-	-	-	-	-	-	-	-	-
M8215	0.8	215	0.68	0.4	125	0.61	0.4	-	-	-	-	-	-	-	-	-
M6330	0.8	185	0.68	0.4	130	0.61	0.4	-	-	-	-	-	-	-	-	-
M8310	0.8	220	0.68	0.4	110	0.52	0.4	-	-	-	-	-	-	-	-	-
M8330	0.8	215	0.68	0.4	125	0.61	0.4	-	-	-	-	-	-	-	-	-
M8340	0.8	200	0.68	0.4	120	0.61	0.4	-	-	-	-	-	-	-	-	-
M9340	0.8	220	0.68	0.4	130	0.61	0.4	-	-	-	-	-	-	-	-	-

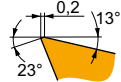

HF2 geometry with positive design for high feed machining.

Product	RE	vc	f	ap	vc	f	ap	vc	f	ap	vc	f	ap	vc	f	ap
ADEX 11T308SR-HF2	0.8	220	0.68	0.4	110	0.61	0.4	205	0.68	0.4	-	-	-	40	0.48	0.3
M8310	0.8	220	0.68	0.4	110	0.61	0.4	205	0.68	0.4	-	-	-	40	0.48	0.3
M8330	0.8	215	0.68	0.4	125	0.61	0.4	200	0.68	0.4	50	0.48	0.3	40	0.48	0.3
M8340	0.8	200	0.68	0.4	120	0.61	0.4	190	0.68	0.4	50	0.48	0.3	-	-	-
M9325	0.8	250	0.68	0.4	-	-	-	235	0.68	0.4	-	-	-	50	0.48	0.3

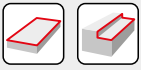

a_e DC	5 %	10 %	15 %	20 %	25 %	30 %	40 %	50 %	60 %	70 %	75 %	80 %	90 %	100 %
	1.48	1.35	1.27	1.22	1.19	1.16	1.11	1.08	1.05	1.03	1.00	1.00	1.00	1.00
	2.20	1.60	1.35	1.20	1.10	0.95	0.85	0.75	0.85	0.95	1.00	1.00	1.00	1.00
	0.64	0.64	0.64	0.64	0.64	0.65	0.65	0.67	0.68	0.71	0.72	0.74	0.79	1.00

	ADMX 11-F		ADMX 11-M								ADMX 11-R		ADMX 11-MF		
	0.4	0.8	0.2	0.4	0.8	1.0	1.2	1.6	2.0	2.5	3.0	0.8	1.6	0.4	0.8
	1.89	1.48	2.09	1.89	1.48	1.27	1.08	0.68	1.61	1.13	0.66	1.48	0.68	1.89	1.48

	ADMX 11-MM				ADEX 11-HF	ADEX 11-HF2
	0.4	0.8	1.2	1.6	0.8	0.8
	1.89	1.48	1.08	0.61	0.17	0.17

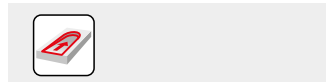
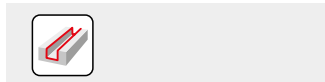
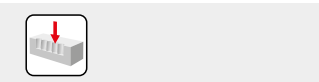
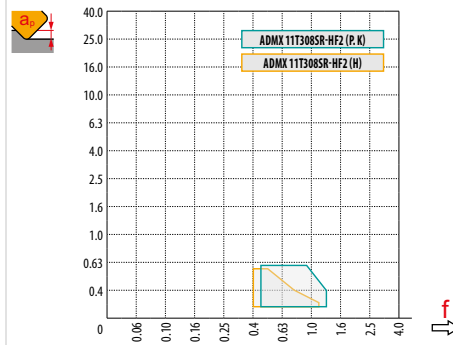
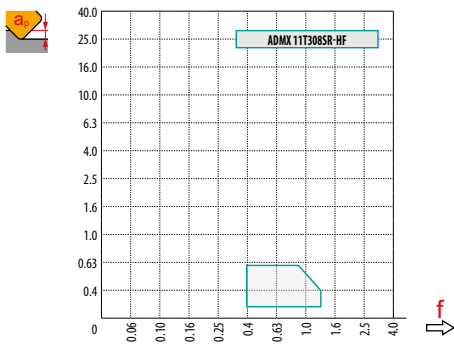
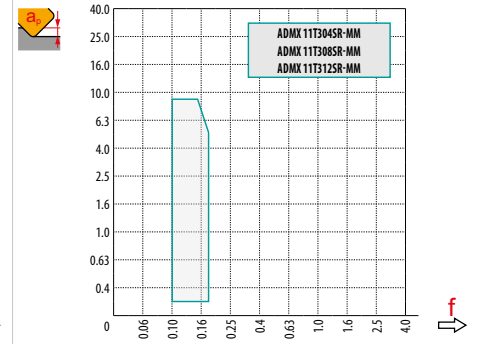
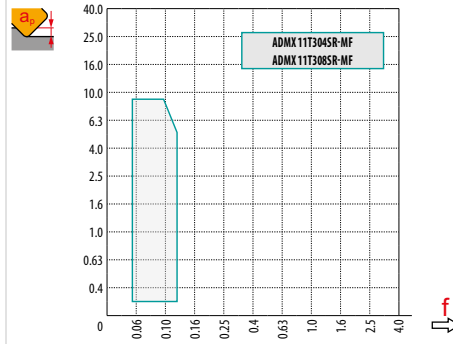
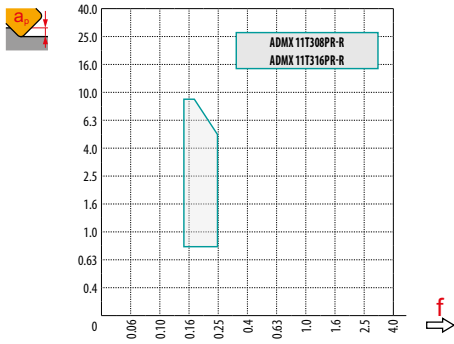
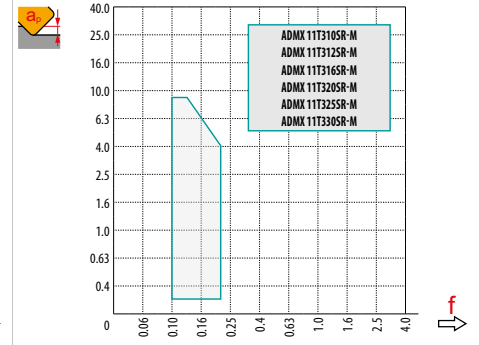
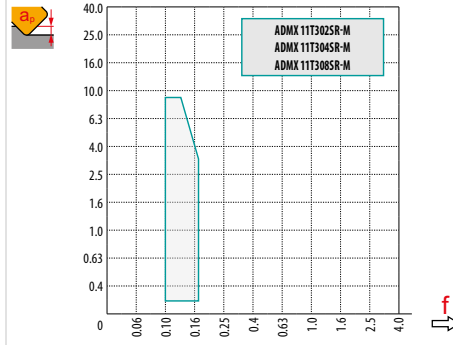
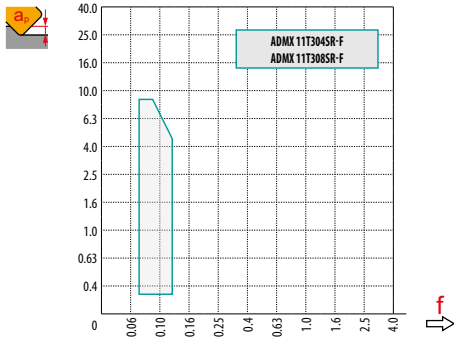

max
4.5

	1.0	5.0	9.0
	0.20	0.13	0.10

	HFC				
	RPMX	APMX/I	RPMX	RPMX	APMX/I
16	13.5	9.0/40	4.1	5.7	0.6/8
18	10.0	9.0/53	2.8	4.5	0.6/12
20	9.0	9.0/59	2.3	4.3	0.6/15
25	6.0	9.0/87	1.3	6.7	0.6/26
32	5.3	9.0/99	0.7	4.3	0.6/49
40	3.8	6.5/100	0.3	2.9	0.6/100
50	2.8	4.7/100	0.1	2.1	0.6/100
63	1.8	3.0/100	-	-	-
80	1.6	2.6/100	-	-	-

* HFC milling
** Conventional milling



DC	HFC							
	DMIN	DMAX	SMAX DMIN	SMAX DMAX	DMIN	DMAX	SMAX DMIN	SMAX DMAX
16	27.0	32.0	8.3	9.0	21.0	32.0	0.6	0.6
18	32.0	36.0	7.5	9.0	29.0	36.0	0.6	0.6
20	35.0	40.0	7.5	9.0	29.0	40.0	0.6	0.6
25	45.0	50.0	6.5	7.5	39.0	50.0	0.6	0.6
32	59.0	64.0	4.0	4.5	53.0	64.0	0.6	0.6
40	75.0	80.0	1.5	2.0	68.5	80.0	0.6	0.6
50	-	-	-	-	88.5	100.0	0.6	0.6

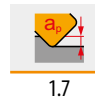

DC	μm	3	5	10	15	20	30	40	50	60	80	100
16		0.438	0.566	0.800	0.980	1.131	1.386	1.600	1.789	1.960	2.263	2.530
18		0.465	0.600	0.849	1.039	1.200	1.470	1.697	1.897	2.078	2.400	2.683
20	FE	0.490	0.632	0.894	1.095	1.265	1.549	1.789	2.000	2.191	2.530	2.828
20		0.490	0.632	0.894	1.095	1.265	1.549	1.789	2.000	2.191	2.530	2.828
25	FE	0.548	0.707	1.000	1.225	1.414	1.732	2.000	2.236	2.449	2.828	3.162
32		0.620	0.800	1.131	1.386	1.600	1.960	2.263	2.530	2.771	3.200	3.578
40	FE	0.693	0.894	1.265	1.549	1.789	2.191	2.530	2.828	3.098	3.578	4.000
50		0.775	1.000	1.414	1.732	2.000	2.449	2.828	3.162	3.464	4.000	4.472
63	FE	0.869	1.122	1.587	1.944	2.245	2.750	3.175	3.550	3.888	4.490	5.020
80		0.980	1.265	1.789	2.191	2.530	3.098	3.578	4.000	4.382	5.060	5.657

RE	μm	3	5	10	15	20	30	40	50	60	80	100
1.0	FE	0.155	0.200	0.283	0.346	0.400	0.490	0.566	0.632	0.693	0.800	0.894
1.2		0.170	0.219	0.310	0.379	0.438	0.537	0.620	0.693	0.759	0.876	0.980
1.6	FE	0.196	0.253	0.358	0.438	0.506	0.620	0.716	0.800	0.876	1.012	1.131
2.0		0.219	0.283	0.400	0.490	0.566	0.693	0.800	0.894	0.980	1.131	1.265
2.5	FE	0.245	0.316	0.447	0.548	0.632	0.775	0.894	1.000	1.095	1.265	1.414
3.0		0.268	0.346	0.490	0.600	0.693	0.849	0.980	1.095	1.200	1.386	1.549

i

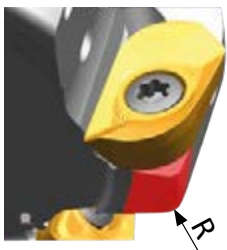

ADMX/ADEX 11	R
ADMX 11T320SR-M	1.0
ADMX 11T325SR-M	1.8
ADMX 11T330SR-M	1.8
ADEX 11T308SR-HF	1.4
ADEX 11T308SR-HF2	1.4

i

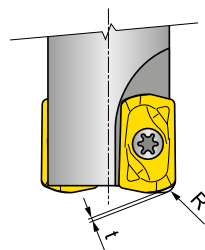

ADEX 11	R	t
ADEX 11T308SR-HF	1.42	0.35
ADEX 11T308SR-HF2	1.34	0.38



SAD16E



PRAMET

S



FORCE AD16 Square Shoulder Mill with Internal Coolant

90° end and shell mills utilising positive AD.. 16 style insert with APMX of 13 mm. Suitable for face, shoulder, slot, helical, trochoidal, ramping and plunge milling. Available in cylindrical, weldon, morse taper, modular and arbor (with differential tooth pitch) style, in Ø25 up to Ø175 mm. Body treated for longer tool life.

FORCE AD

KAPR	90°
APMX	13.0 mm

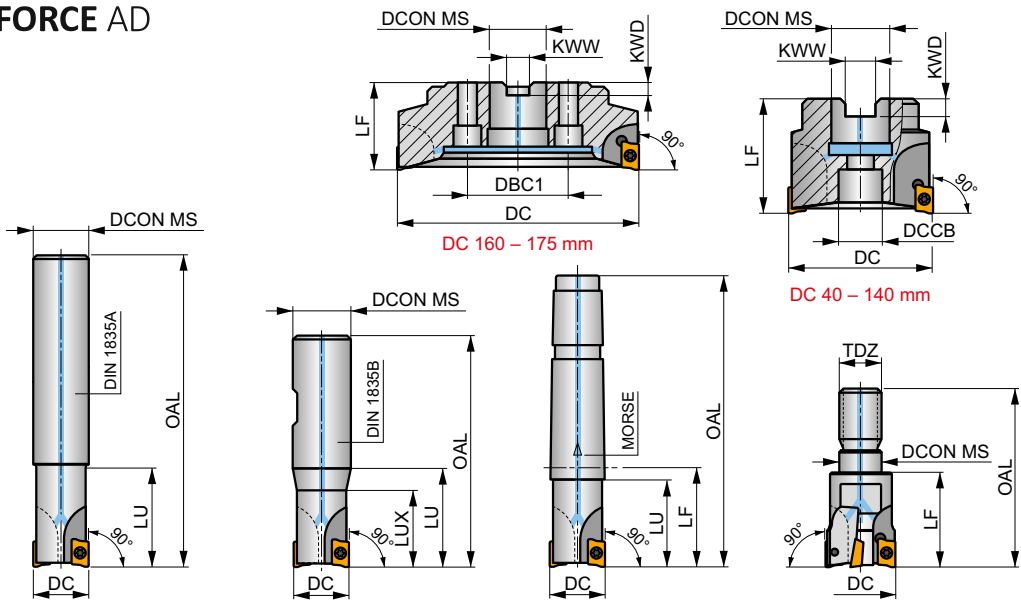
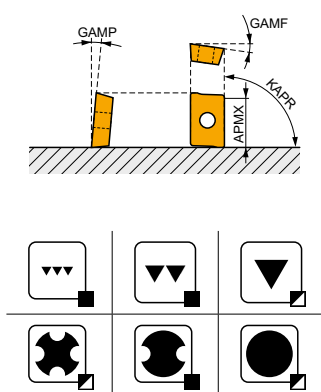

	0.06 - 0.18
	0.08 - 0.22



Product	DC	OAL	DCON MS	DCCB	DBC1	LU	LUX	LF	TDZ	CZC MS	KWW	KWD	GAMF	GAMP	max.			kg	G1165		
	(mm)	(mm)	(mm)	(mm)	(mm)	(mm)	(mm)	(mm)	(mm)	(mm)	(mm)	(mm)	(°)	(°)	rpm	m/min	kg	SQ030	AC001		
25A2R033A25-SAD16E-C	25	165	25	-	-	33	-	-	-	-	-	-	-13	5	2	-	18700	✓	0.52	G1165 SQ030	-
25A2R038A25-SAD16E-C	25	200	25	-	-	38	-	-	-	-	-	-	-13	5	2	-	18700	✓	0.71	G1165 SQ030	-
32A3R033A32-SAD16E-C	32	195	32	-	-	33	-	-	-	-	-	-	-12	7	3	-	16500	✓	1.03	G1165 SQ030	-
32A3R048A32-SAD16E-C	32	250	32	-	-	48	-	-	-	-	-	-	-12	7	3	-	16500	✓	1.37	G1165 SQ030	-
25A2R042B25-SAD16E-C	25	98	25	-	-	-	42	-	-	-	-	-	-13	5	2	-	18700	✓	0.29	G1165 SQ030	-
32A3R040B32-SAD16E-C	32	100	32	-	-	-	40	-	-	-	-	-	-12	7	3	-	16500	✓	0.50	G1165 SQ030	-
40A4R050B32-SAD16E-C	40	110	32	-	-	-	50	-	-	-	-	-	-8.2	10.5	3	-	14800	✓	0.59	G1165 SQ030	-
40A4R050B32-SAD16E-C	40	110	32	-	-	-	50	-	-	-	-	-	-8.2	10.5	4	-	14800	✓	0.65	G1165 SQ030	-
25A2R043E03-SAD16E-C	25	98	-	-	-	38	-	43	-	3	-	-	-13	5	2	-	18600	✓	0.31	G1165 SQ030	-
32A3R043E03-SAD16E-C	32	100	-	-	-	38	-	43	-	3	-	-	-12	7	3	-	16500	✓	0.33	G1165 SQ030	-
40A3R054E04-SAD16E-C	40	110	-	-	-	48	-	54	-	4	-	-	-8.2	10.5	3	-	14700	✓	0.74	G1165 SQ030	-
40A4R054E04-SAD16E-C	40	110	-	-	-	48	-	54	-	4	-	-	-8.2	10.5	4	-	14700	✓	0.70	G1165 SQ030	-
32A3R043M16-SAD16E-C	32	66	17	-	-	-	-	43	M16	-	-	-	-12	7	3	-	-	✓	0.20	G1165 SQ030	-
40A4R043M16-SAD16E-C	40	66	17	-	-	-	-	43	M16	-	-	-	-8.2	10.5	4	-	-	✓	0.27	G1165 SQ030	-
40A04R-S90AD16E-C	40	-	16	14	-	-	-	40	-	-	8.4	5.6	-8.2	10.5	4	-	14700	✓	0.21	G1165 SQ032	-
50A03R-S90AD16E-C	50	-	22	18	-	-	-	40	-	-	10.4	6.3	-7	11	3	-	13200	✓	0.43	G1165 SQ033	-
50A05R-S90AD16E-C	50	-	22	18	-	-	-	40	-	-	10.4	6.3	-7	11	5	✓	13200	✓	0.59	G1165 SQ033	-
63A04R-S90AD16E-C	63	-	22	18	-	-	-	40	-	-	10.4	6.3	-6	12	4	✓	11800	✓	0.62	G1165 SQ033	-
63A06R-S90AD16E-C	63	-	22	18	-	-	-	40	-	-	10.4	6.3	-6	12	6	✓	11800	✓	0.46	G1165 SQ033	-
80A05R-S90AD16E-C	80	-	27	38	-	-	-	50	-	-	12.4	7	-5	12	5	✓	10400	✓	1.01	G1165 SQ031 AC001	-
80A07R-S90AD16E-C	80	-	27	38	-	-	-	50	-	-	12.4	7	-5	13	7	✓	10400	✓	0.97	G1165 SQ031 AC001	-
100A06R-S90AD16E-C	100	-	32	45	-	-	-	50	-	-	14.4	8	-4	12	6	✓	9300	✓	1.89	G1165 SQ031 AC002	-
100A08R-S90AD16E-C	100	-	32	45	-	-	-	50	-	-	14.4	8	-4	12	8	✓	9300	✓	1.69	G1165 SQ031 AC002	-
125A09R-S90AD16E-C	125	-	40	56	-	-	-	63	-	-	16.4	9	-3.8	12	9	✓	8400	✓	3.46	G1165 SQ031 AC003	-
140A08R-S90AD16E-C	140	-	40	56	-	-	-	63	-	-	16.4	9	-3.8	12	8	✓	7900	✓	4.06	G1165 SQ031	-
160C10R-S90AD16E-C	160	-	40	-	66.7	-	-	63	-	-	16.4	9.2	-3.8	10	10	✓	7300	✓	6.04	G1165 SQ036	-
175C10R-S90AD16E-C	175	-	40	-	66.7	-	-	63	-	-	16.4	9.2	-3.8	12	10	✓	7000	✓	7.00	G1165 SQ036	-



GI165	ADMX 1606..	ADEX 1606..

SQ030	US 4008-T15P	3.5	M 4	8	–	–	Flag T15P	–	–	–	–
SQ031	US 4011-T15P	3.5	M 4	10.6	D-T08P/T15P	FG-15	–	–	–	–	–
SQ032	US 4008-T15P	3.5	M 4	8	D-T08P/T15P	FG-15	–	HS 0830C	–	–	–
SQ033	US 4011-T15P	3.5	M 4	10.6	D-T08P/T15P	FG-15	–	HS 1030C	–	–	–
SQ036	US 4011-T15P	3.5	M 4	10.6	D-T08P/T15P	FG-15	–	HS 1240C	CAC 160C	HSD 0825C	HXK 5

AC001	KS 1230	K.FMH27
AC002	KS 1635	K.FMH32
AC003	KS 2040	K.FMH40

ADMX 16



	W1	D1	L	S
	(mm)	(mm)	(mm)	(mm)
1606	9.950	4.50	16.00	6.25

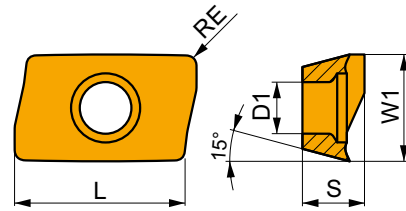

Suitability and starting values for cutting speed (vc), feed (f) and depth of cut (ap). Refer to our Machining Calculator app for further calculations.

Product	RE	P			M			K			N			S			H		
		vc	f	ap	vc	f	ap	vc	f	ap	vc	f	ap	vc	f	ap	vc	f	ap
	(mm)	(m/min)	(mm/tooth)	(mm)	(m/min)	(mm/tooth)	(mm)	(m/min)	(mm/tooth)	(mm)	(m/min)	(mm/tooth)	(mm)	(m/min)	(mm/tooth)	(mm)	(m/min)	(mm/tooth)	(mm)

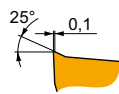
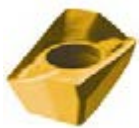

F geometry with highly positive design for light to medium machining.

ADMX 160608SR-F	8215	0.8	290	0.10	2.0	170	0.09	2.0	275	0.10	2.0	870	0.12	2.0	70	0.07	1.6	–	–	–
	M8310	0.8	320	0.10	2.0	160	0.09	2.0	300	0.10	2.0	–	–	–	–	–	–	–	–	–
	M8330	0.8	285	0.10	2.0	170	0.09	2.0	270	0.10	2.0	855	0.12	2.0	70	0.07	1.6	–	–	–
	M8340	0.8	260	0.10	2.0	155	0.09	2.0	245	0.10	2.0	–	–	–	65	0.07	1.6	–	–	–
	M9340	0.8	340	0.10	2.0	200	0.09	2.0	–	–	–	–	–	–	85	0.07	1.6	–	–	–

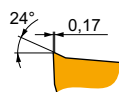
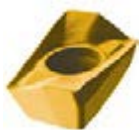

M geometry with positive design for light to medium machining.

ADMX 160604SR-M	8215	0.4	190	0.18	5.0	110	0.16	5.0	180	0.18	5.0	–	–	–	45	0.13	4.0	–	–	–
	M8330	0.4	190	0.18	5.0	110	0.16	5.0	180	0.18	5.0	–	–	–	45	0.13	4.0	–	–	–
	M8340	0.4	170	0.18	5.0	100	0.16	5.0	160	0.18	5.0	–	–	–	40	0.13	4.0	–	–	–



Suitability and starting values for cutting speed (vc), feed (f) and depth of cut (ap). Refer to our Machining Calculator app for further calculations.

Product	RE (mm)	P			M			K			N			S			H		
		vc (m/min)	f (mm/tooth)	ap (mm)	vc (m/min)	f (mm/tooth)	ap (mm)	vc (m/min)	f (mm/tooth)	ap (mm)	vc (m/min)	f (mm/tooth)	ap (mm)	vc (m/min)	f (mm/tooth)	ap (mm)	vc (m/min)	f (mm/tooth)	ap (mm)

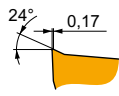

M geometry with positive design for light to medium machining.

ADMX 160608SR-M	8215	0.8	225	0.18	5.0	135	0.16	5.0	210	0.18	5.0	-	-	-	55	0.13	4.0	-	-	-
	M5315	0.8	305	0.18	5.0	-	-	-	285	0.18	5.0	-	-	-	-	-	-	-	-	-
	M8310	0.8	250	0.18	5.0	125	0.16	5.0	235	0.18	5.0	-	-	-	-	-	-	-	-	
	M8330	0.8	225	0.18	5.0	135	0.16	5.0	210	0.18	5.0	-	-	-	55	0.13	4.0	-	-	-
	M8340	0.8	205	0.18	5.0	120	0.16	5.0	190	0.18	5.0	-	-	-	50	0.13	4.0	-	-	-
	M9315	0.8	305	0.18	5.0	-	-	-	285	0.18	5.0	-	-	-	-	-	-	-	-	-
	M9325	0.8	280	0.18	5.0	-	-	-	265	0.18	5.0	-	-	-	-	-	-	-	-	-
ADMX 160616SR-M	M9340	0.8	255	0.18	5.0	150	0.16	5.0	-	-	-	-	-	60	0.13	4.0	-	-	-	
	8215	1.6	250	0.18	5.0	150	0.16	5.0	235	0.18	5.0	-	-	-	60	0.13	4.0	-	-	-
	M8310	1.6	275	0.18	5.0	140	0.16	5.0	260	0.18	5.0	-	-	-	-	-	-	-	-	
	M8330	1.6	250	0.18	5.0	150	0.16	5.0	235	0.18	5.0	-	-	-	60	0.13	4.0	-	-	-
	M8340	1.6	225	0.18	5.0	135	0.16	5.0	210	0.18	5.0	-	-	-	55	0.13	4.0	-	-	-
ADMX 160620SR-M	M9325	1.6	310	0.18	5.0	-	-	-	290	0.18	5.0	-	-	-	-	-	-	-	-	-
	M8330	2.0	265	0.18	5.0	155	0.16	5.0	250	0.18	5.0	-	-	-	65	0.13	4.0	-	-	-
ADMX 160630SR-M	M8340	2.0	240	0.18	5.0	140	0.16	5.0	225	0.18	5.0	-	-	-	60	0.13	4.0	-	-	-
	M8330	3.0	265	0.18	5.0	155	0.16	5.0	250	0.18	5.0	-	-	-	65	0.13	4.0	-	-	-
ADMX 160632SR-M	M8340	3.0	240	0.18	5.0	140	0.16	5.0	225	0.18	5.0	-	-	-	60	0.13	4.0	-	-	-
	M6330	3.2	225	0.18	5.0	155	0.16	5.0	-	-	-	-	-	65	0.13	4.0	-	-	-	
ADMX 160640SR-M	M8330	3.2	265	0.18	5.0	155	0.16	5.0	250	0.18	5.0	-	-	-	65	0.13	4.0	-	-	-
	M8340	3.2	240	0.18	5.0	140	0.16	5.0	225	0.18	5.0	-	-	-	60	0.13	4.0	-	-	-
	M9325	3.2	325	0.18	5.0	-	-	-	305	0.18	5.0	-	-	-	-	-	-	-	-	-
ADMX 160650SR-M	M8330	4.0	265	0.18	5.0	155	0.16	5.0	250	0.18	5.0	-	-	-	65	0.13	4.0	-	-	-
	M8340	4.0	240	0.18	5.0	140	0.16	5.0	225	0.18	5.0	-	-	-	60	0.13	4.0	-	-	-
ADMX 160650SR-M	M8330	5.0	265	0.18	5.0	155	0.16	5.0	250	0.18	5.0	-	-	-	65	0.13	4.0	-	-	-
	M8340	5.0	240	0.18	5.0	140	0.16	5.0	225	0.18	5.0	-	-	-	60	0.13	4.0	-	-	-

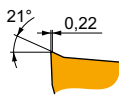

R geometry with positive design for medium to less stable machining conditions.

ADMX 160608PR-R	8215	0.8	205	0.25	6.0	120	0.23	6.0	190	0.25	6.0	-	-	-	50	0.20	4.8	40	0.16	1.1
	M5315	0.8	260	0.25	6.0	-	-	-	245	0.25	6.0	-	-	-	-	-	-	50	0.16	1.1
	M8310	0.8	220	0.25	6.0	110	0.23	6.0	205	0.25	6.0	-	-	-	-	-	-	40	0.16	1.1
	M8330	0.8	205	0.25	6.0	120	0.23	6.0	190	0.25	6.0	-	-	-	50	0.20	4.8	40	0.16	1.1
	M8340	0.8	190	0.25	6.0	110	0.23	6.0	180	0.25	6.0	-	-	-	45	0.20	4.8	-	-	-
	M9315	0.8	265	0.25	6.0	-	-	-	250	0.25	6.0	-	-	-	-	-	-	50	0.16	1.1
	M9325	0.8	250	0.25	6.0	-	-	-	235	0.25	6.0	-	-	-	-	-	-	50	0.16	1.1
ADMX 160616PR-R	M8330	1.6	225	0.25	6.0	135	0.23	6.0	210	0.25	6.0	-	-	-	55	0.20	4.8	45	0.16	1.1
	M8340	1.6	210	0.25	6.0	125	0.23	6.0	195	0.25	6.0	-	-	-	50	0.20	4.8	-	-	-
	M9315	1.6	295	0.25	6.0	-	-	-	280	0.25	6.0	-	-	-	-	-	-	55	0.16	1.1

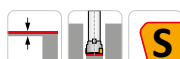
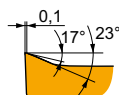

MF geometry with highly positive design for finish machining.

ADMX 160608SR-MF	M6330	0.8	215	0.08	4.0	150	0.07	4.0	-	-	-	-	-	60	0.06	3.2	-	-	-
	M8340	0.8	225	0.08	4.0	135	0.07	4.0	-	-	-	-	-	55	0.06	3.2	-	-	-
	M9340	0.8	305	0.08	4.0	180	0.07	4.0	-	-	-	-	-	75	0.06	3.2	-	-	-

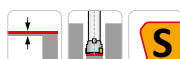
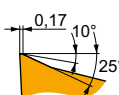

MM geometry with highly positive design for light to medium machining.

ADMX 160604SR-MM	M6330	0.4	145	0.18	4.0	105	0.16	4.0	-	-	-	-	-	40	0.14	3.2	-	-	-
	M8340	0.4	160	0.18	4.0	95	0.16	4.0	-	-	-	-	-	40	0.14	3.2	-	-	-



Suitability and starting values for cutting speed (vc), feed (f) and depth of cut (ap). Refer to our Machining Calculator app for further calculations.

Product	RE (mm)	P			M			K			N			S			H		
		vc (m/min)	f (mm/tooth)	ap (mm)	vc (m/min)	f (mm/tooth)	ap (mm)	vc (m/min)	f (mm/tooth)	ap (mm)	vc (m/min)	f (mm/tooth)	ap (mm)	vc (m/min)	f (mm/tooth)	ap (mm)	vc (m/min)	f (mm/tooth)	ap (mm)

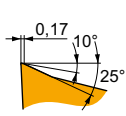

MM geometry with highly positive design for light to medium machining.

ADMX 160608SR-MM	M6330	0.8	175	0.18	4.0	125	0.16	4.0	—	—	—	—	—	—	50	0.14	3.2	—	—	—
	M8340	0.8	190	0.18	4.0	110	0.16	4.0	—	—	—	—	—	—	45	0.14	3.2	—	—	—
	M8345	0.8	150	0.18	4.0	90	0.16	4.0	—	—	—	—	—	—	35	0.14	3.2	—	—	—
ADMX 160616SR-MM	M9340	0.8	235	0.18	4.0	140	0.16	4.0	—	—	—	—	—	—	55	0.14	3.2	—	—	—
	M6330	1.6	195	0.18	4.0	140	0.16	4.0	—	—	—	—	—	—	55	0.14	3.2	—	—	—
	M8340	1.6	210	0.18	4.0	125	0.16	4.0	—	—	—	—	—	—	50	0.14	3.2	—	—	—
	M8345	1.6	165	0.18	4.0	95	0.16	4.0	—	—	—	—	—	—	40	0.14	3.2	—	—	—
	M9340	1.6	260	0.18	4.0	155	0.16	4.0	—	—	—	—	—	—	65	0.14	3.2	—	—	—

ADEX 16



	W1 (mm)	D1 (mm)	L (mm)	S (mm)
1606	9.950	4.50	16.00	6.25

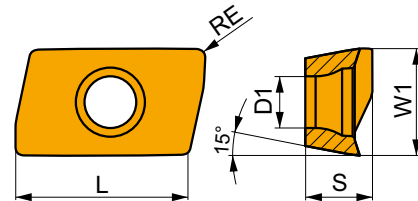

Suitability and starting values for cutting speed (vc), feed (f) and depth of cut (ap). Refer to our Machining Calculator app for further calculations.

Product	RE (mm)	P			M			K			N			S			H		
		vc (m/min)	f (mm/tooth)	ap (mm)	vc (m/min)	f (mm/tooth)	ap (mm)	vc (m/min)	f (mm/tooth)	ap (mm)	vc (m/min)	f (mm/tooth)	ap (mm)	vc (m/min)	f (mm/tooth)	ap (mm)	vc (m/min)	f (mm/tooth)	ap (mm)

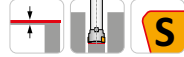
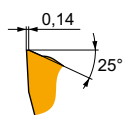

FM geometry with highly positive design for medium machining.

ADEX 160608SR-FM	8215	0.8	260	0.16	2.0	155	0.14	2.0	245	0.16	2.0	—	—	—	65	0.11	1.6	—	—	—
	M8330	0.8	255	0.16	2.0	150	0.14	2.0	240	0.16	2.0	—	—	—	60	0.11	1.6	—	—	—
	M8340	0.8	235	0.16	2.0	140	0.14	2.0	220	0.16	2.0	—	—	—	55	0.11	1.6	—	—	—



ADEX 16-HF

	W1	D1	L	S
	(mm)	(mm)	(mm)	(mm)
1606	9.950	4.50	16.00	5.88

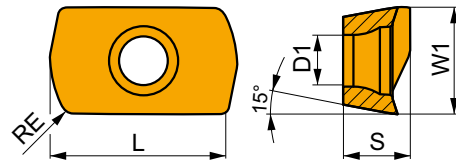

Suitability and starting values for cutting speed (vc), feed (f) and depth of cut (ap). Refer to our Machining Calculator app for further calculations.

Product	RE (mm)	P			M			K			N			S			H		
		vc (m/min)	f (mm/tooth)	ap (mm)	vc (m/min)	f (mm/tooth)	ap (mm)	vc (m/min)	f (mm/tooth)	ap (mm)	vc (m/min)	f (mm/tooth)	ap (mm)	vc (m/min)	f (mm/tooth)	ap (mm)	vc (m/min)	f (mm/tooth)	ap (mm)

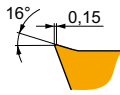

HF geometry with highly positive design for high feed machining.

ADEX 160612SR-HF	8215	1.2	■	195	1.00	0.6	▣	115	0.90	0.6	■	-	-	-	-	-	-	-	-
	M8310	1.2	■	205	1.00	0.6	▣	100	0.77	0.6	■	-	-	-	-	-	-	-	-
	M8330	1.2	■	200	1.00	0.6	▣	120	0.90	0.6	■	-	-	-	-	-	-	-	-
	M8340	1.2	■	185	1.00	0.6	▣	110	0.90	0.6	■	-	-	-	-	-	-	-	-
	M9340	1.2	■	195	1.00	0.6	▣	115	0.90	0.6	■	-	-	-	-	-	-	-	-

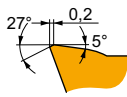

HF2 geometry with positive design for high feed machining.

ADEX 160612SR-HF2	M8310	1.2	■	205	0.90	0.6	▣	100	0.81	0.6	■	190	0.90	0.6	-	-	-	▣	40	0.63	0.5
	M8330	1.2	■	205	0.90	0.6	▣	120	0.81	0.6	■	190	0.90	0.6	-	-	-	▣	50	0.81	0.5
	M8340	1.2	■	190	0.90	0.6	▣	110	0.81	0.6	■	180	0.90	0.6	-	-	-	▣	45	0.81	0.5
	M9325	1.2	■	230	0.90	0.6	▣	-	-	-	■	215	0.90	0.6	-	-	-	▣	45	0.63	0.5

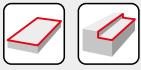

a_e DC	5 %	10 %	15 %	20 %	25 %	30 %	40 %	50 %	60 %	70 %	75 %	80 %	90 %	100 %
X.V	1.48	1.35	1.27	1.22	1.19	1.16	1.11	1.08	1.05	1.03	1.00	1.00	1.00	1.00
x.f	2.20	1.60	1.35	1.20	1.10	0.95	0.85	0.75	0.85	0.95	1.00	1.00	1.00	1.00
x.f	0.64	0.64	0.64	0.64	0.64	0.65	0.65	0.67	0.68	0.71	0.72	0.74	0.79	1.00

RE	ADMX 16-F	ADEX 16-FM	ADMX 16-M								ADMX 16-R	
RE	0.8	0.8	0.4	0.8	1.6	2.0	3.0	3.2	4.0	5.0	0.8	1.6
BS	2.99	2.18	3.39	2.99	1.62	1.23	0.28	0.09	2.69	1.52	2.99	1.62

RE	ADMX 16-MF	ADMX 16-MM			ADEX 16-HF	ADEX 16-HF2
RE	0.8	0.4	0.8	1.6	1.2	1.2
BS	2.99	3.39	2.99	1.62	0.52	0.52

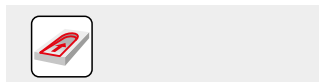
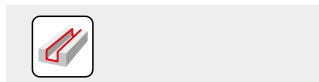
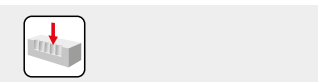
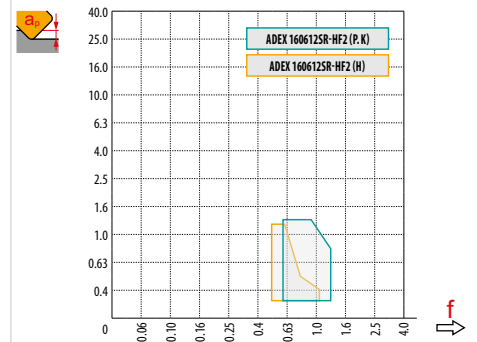
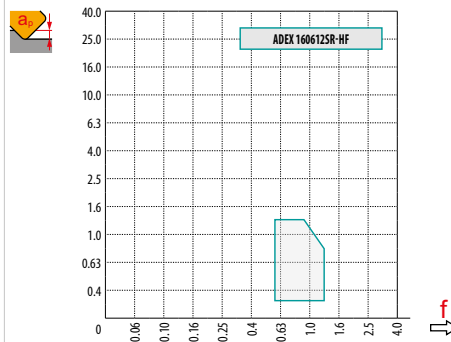
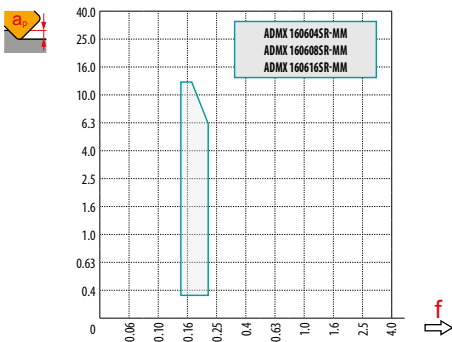
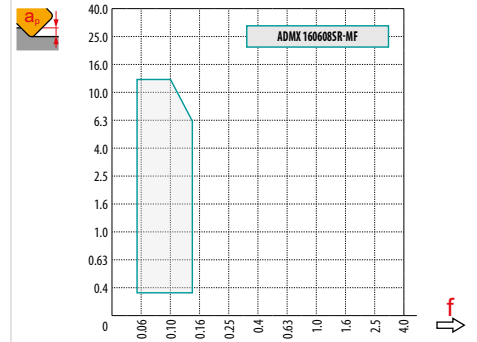
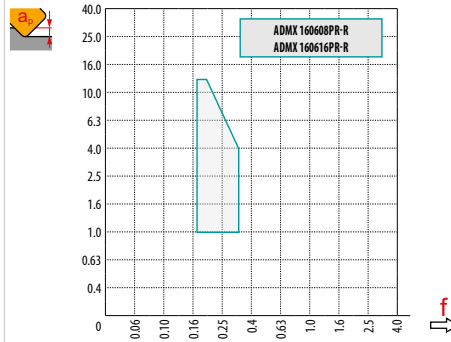
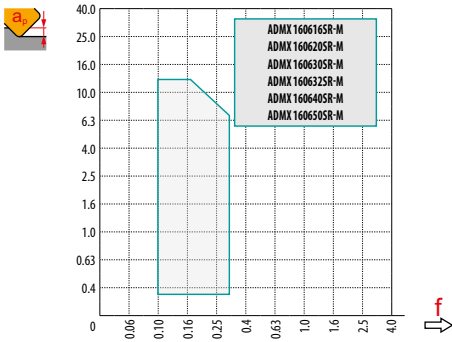
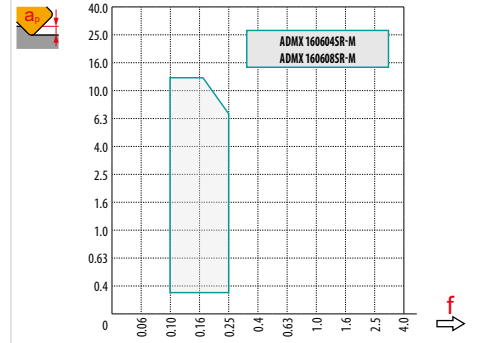
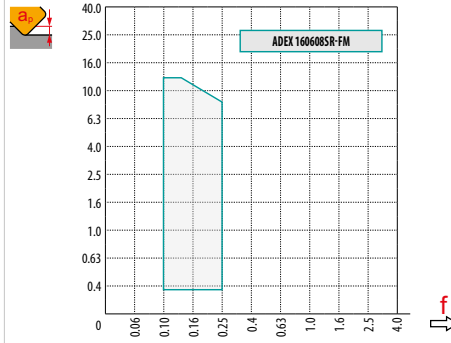
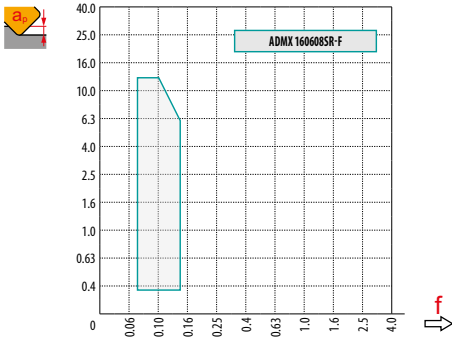

max
7.5

	1.0	6.0	13.0
	0.28	0.19	0.10

DC	HFC				
	RPMX	APMX/I	RPMX	RPMX	APMX/I
25	12.5	13.0/60	4.0	8.0	1.3/19
32	7.5	13.0/100	2.0	7.5	1.3/38
40	5.0	8.6/100	1.2	4.5	1.3/65
50	3.5	6.0/100	0.8	3.0	1.3/100
63	2.5	4.2/100	0.5	2.0	0.8/100
80	2.0	3.3/100	0.4	1.5	0.6/100

* HFC milling
** Conventional milling



DC	HFC							
	DMIN	DMAX	SMAX DMIN	SMAX DMAX	DMIN	DMAX	SMAX DMIN	SMAX DMAX
25	42.0	50.0	10.0	12.5	42.0	50.0	1.3	1.3
32	55.0	64.0	6.5	9.0	55.0	64.0	1.3	1.3
40	72.0	80.0	5.0	8.0	72.0	80.0	1.3	1.3
50	92.0	100.0	4.5	6.0	92.0	100.0	1.3	1.3
63	118.0	126.0	4.0	5.0	118.0	126.0	1.3	1.3
80	136.0	160.0	1.5	2.0	136.0	160.0	1.3	1.3



DC	μm	3	5	10	15	20	30	40	50	60	80	100
25		0.548	0.707	1.000	1.225	1.414	1.732	2.000	2.236	2.449	2.828	3.162
32		0.620	0.800	1.131	1.386	1.600	1.960	2.263	2.530	2.771	3.200	3.578
40		0.693	0.894	1.265	1.549	1.789	2.191	2.530	2.828	3.098	3.578	4.000
50		0.775	1.000	1.414	1.732	2.000	2.449	2.828	3.162	3.464	4.000	4.472
63		0.869	1.122	1.587	1.944	2.245	2.750	3.175	3.550	3.888	4.490	5.020
80		0.980	1.265	1.789	2.191	2.530	3.098	3.578	4.000	4.382	5.060	5.657

RE	μm	3	5	10	15	20	30	40	50	60	80	100
1.6		0.196	0.253	0.358	0.438	0.506	0.620	0.716	0.800	0.876	1.012	1.131
2.0		0.219	0.283	0.400	0.490	0.566	0.693	0.800	0.894	0.980	1.131	1.265
3.0		0.268	0.346	0.490	0.600	0.693	0.849	0.980	1.095	1.200	1.386	1.549
3.2		0.277	0.358	0.506	0.620	0.716	0.876	1.012	1.131	1.239	1.431	1.600
4.0		0.310	0.400	0.566	0.693	0.800	0.980	1.131	1.265	1.386	1.600	1.789
5.0		0.346	0.447	0.632	0.775	0.894	1.095	1.265	1.414	1.549	1.789	2.000

i

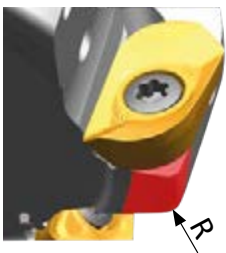

ADMX/ADEX 16	R
ADMX 160630SR-M	2.5
ADMX 160632SR-M	2.5
ADMX 160640SR-M	4.0
ADMX 160650SR-M	4.5
ADEX 160612SR-HF	3.0
ADEX 160612SR-HF2	3.0

i

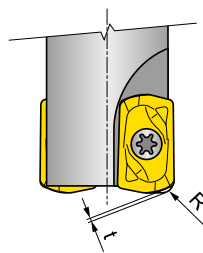

ADEX 16	R	t
ADEX 160612SR-HF	2.59	0.56
ADEX 160612SR-HF2	2.48	0.57



SLN12



PRAMET

S



ECON LN12 Square Shoulder Mill with Internal Coolant

90° end and shell mills utilising double sided LN.. 12 inserts with APMX of 9 mm. Suitable for a wide range of applications. Available in cylindrical, weldon, modular and arbor (with differential tooth pitch) style, in Ø25 up to Ø125 mm. Body treated for longer tool life.

ECON LN

KAPR	90°
APMX	9.0 mm

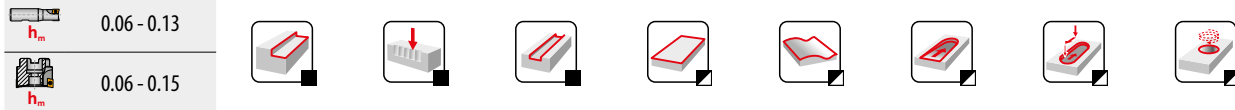
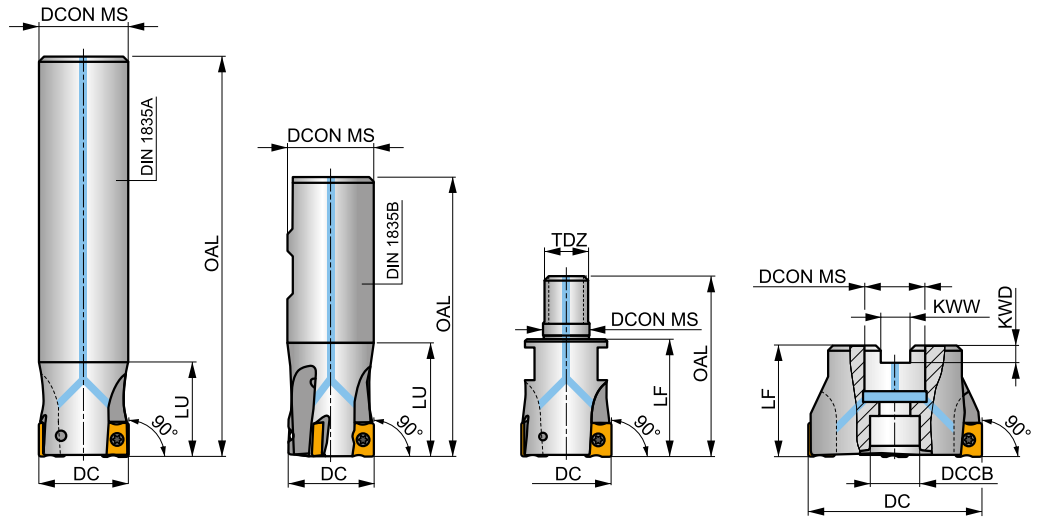
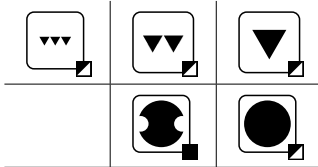
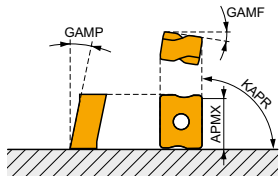

Product	DC	OAL	DCON MS	DCCB	LU	LF	TDZ	KWW	KWD	GAMF	GAMP	max.	kg	G	S	AC	
	(mm)	(mm)	(mm)	(mm)	(mm)	(mm)	(mm)	(mm)	(mm)	(°)	(°)						
25A2R034A25-SLN12-C	25	170	25	-	34	-	-	-	-	-23	-8	2	-	19500	✓	0.58	GI205 SQ340 -
25A2R080A25-SLN12-C	25	170	25	-	80	-	-	-	-	-23	-8	2	-	19500	✓	0.51	GI205 SQ340 -
32A2R034A32-SLN12-C	32	195	32	-	34	-	-	-	-	-15	-6	2	-	17300	✓	1.05	GI205 SQ340 -
32A2R090A32-SLN12-C	32	195	32	-	90	-	-	-	-	-15	-6	2	-	17300	✓	0.98	GI205 SQ340 -
25A2R042B25-SLN12-C	25	99	25	-	42	-	-	-	-	-23	-8	2	-	19500	✓	0.30	GI205 SQ340 -
32A3R042B32-SLN12-C	32	103	32	-	42	-	-	-	-	-15	-6	3	-	17300	✓	0.50	GI205 SQ340 -
40A4R050B32-SLN12-C	40	111	32	-	50	-	-	-	-	-15	-6	4	✓	15500	✓	0.62	GI205 SQ340 -
25A2R033M12-SLN12-C	25	55	12.5	-	-	33	-	-	-	-22	-6	2	-	-	✓	0.12	GI205 SQ340 -
32A2R043M16-SLN12-C	32	66	17	-	-	43	-	-	-	-15	-6	2	-	-	✓	0.22	GI205 SQ340 -
32A3R043M16-SLN12-C	32	66	17	-	-	43	-	-	-	-15	-6	3	-	-	✓	0.23	GI205 SQ340 -
40A3R043M16-SLN12-C	40	66	17	-	-	43	-	-	-	-15	-6	3	-	-	✓	0.30	GI205 SQ340 -
40A04R-S90LN12-C	40	-	16	14	-	40	-	8.4	5.6	-15	-6	4	✓	15500	✓	0.23	GI205 SQ342 -
50A04R-S90LN12-C	50	-	22	18	-	40	-	10.4	6.3	-14.5	-6	4	✓	13800	✓	0.35	GI205 SQ343 -
50A05R-S90LN12-C	50	-	22	18	-	40	-	10.4	6.3	-14.5	-6	5	✓	13800	✓	0.11	GI205 SQ343 -
63A04R-S90LN12-C	63	-	22	18	-	40	-	10.4	6.3	-14	-6	4	✓	12300	✓	0.55	GI205 SQ343 -
63A06R-S90LN12-C	63	-	22	18	-	40	-	10.4	6.3	-14	-6	6	✓	12300	✓	0.50	GI205 SQ343 -
80A05R-S90LN12-C	80	-	27	38	-	50	-	12.4	7	-14	-6	5	✓	10900	✓	1.18	GI205 SQ341 AC001
80A07R-S90LN12-C	80	-	27	38	-	50	-	12.4	7	-14	-6	7	✓	10900	✓	1.02	GI205 SQ341 AC001
100A06R-S90LN12-C	100	-	32	45	-	50	-	14.4	8	-14	-6	6	✓	9800	✓	1.78	GI205 SQ341 AC002
100A08R-S90LN12-C	100	-	32	45	-	50	-	14.4	8	-14	-6	8	✓	9800	✓	2.01	GI205 SQ341 AC002
110A06R-S90LN12-C	110	-	32	45	-	50	-	14.4	8	-14	-6	6	✓	9300	✓	2.09	GI205 SQ341 AC002
125A07R-S90LN12-C	125	-	40	56	-	63	-	16.4	9	-14	-6	7	✓	8700	✓	3.44	GI205 SQ341 AC003
125A09R-S90LN12-C	125	-	40	56	-	63	-	16.4	9	-14	-6	9	✓	8700	✓	3.38	GI205 SQ341 AC003



GI205



LNGX 1205..



LNGU 1205..



SQ340	US 44012-T15P	3.5	M 4	12	–	–	–	Flag T15P	–
SQ341	US 44012-T15P	3.5	M 4	12	D-T08P/T15P	FG-15	–	–	–
SQ342	US 44012-T15P	3.5	M 4	12	D-T08P/T15P	FG-15	–	–	HS 0830C
SQ343	US 44012-T15P	3.5	M 4	12	D-T08P/T15P	FG-15	–	–	HS 1030C

AC001		KS 1230	K.FMH27
AC002		KS 1635	K.FMH32
AC003		KS 2040	K.FMH40

LNGX 12



	W1	D1	L	S
	(mm)	(mm)	(mm)	(mm)
1205	9.500	4.50	12.00	5.96

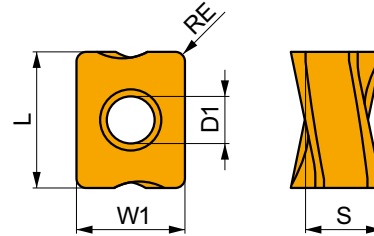

Suitability and starting values for cutting speed (vc), feed (f) and depth of cut (ap). Refer to our Machining Calculator app for further calculations.

Product	RE	P			M			K			N			S			H		
		vc	f	ap	vc	f	ap	vc	f	ap	vc	f	ap	vc	f	ap	vc	f	ap
	(mm)	(m/min)	(mm/tooth)	(mm)	(m/min)	(mm/tooth)	(mm)	(m/min)	(mm/tooth)	(mm)	(m/min)	(mm/tooth)	(mm)	(m/min)	(mm/tooth)	(mm)	(m/min)	(mm/tooth)	(mm)

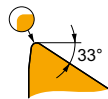

F geometry with highly positive design for light machining.

LNGX 120504ER-F	8215	0.4	■	200	0.15	1.5	–	–	–	■	190	0.15	1.5	–	–	–	–	–	–	–
	M8330	0.4	■	200	0.15	1.5	–	–	–	■	190	0.15	1.5	–	–	–	–	–	–	–
	M8340	0.4	■	180	0.15	1.5	–	–	–	■	170	0.15	1.5	–	–	–	–	–	–	–
LNGX 120508ER-F	8215	0.8	■	240	0.15	1.5	–	–	–	■	225	0.15	1.5	–	–	–	–	–	–	–
	M8310	0.8	■	260	0.15	1.5	–	–	–	■	245	0.15	1.5	–	–	–	–	–	–	–
	M8330	0.8	■	235	0.15	1.5	–	–	–	■	220	0.15	1.5	–	–	–	–	–	–	–
	M8340	0.8	■	215	0.15	1.5	–	–	–	■	200	0.15	1.5	–	–	–	–	–	–	–

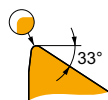

M geometry with positive design for light to medium machining.

LNGX 120504ER-M	M8330	0.4	■	185	0.15	3.0	–	–	–	■	175	0.15	3.0	–	–	–	–	–	–
	M8340	0.4	■	170	0.15	3.0	–	–	–	■	160	0.15	3.0	–	–	–	–	–	–
LNGX 120508ER-M	8215	0.8	■	220	0.15	3.0	–	–	–	■	205	0.15	3.0	–	–	–	–	–	–
	M8310	0.8	■	240	0.15	3.0	–	–	–	■	225	0.15	3.0	–	–	–	–	–	–
	M8330	0.8	■	220	0.15	3.0	–	–	–	■	205	0.15	3.0	–	–	–	–	–	–
	M8340	0.8	■	200	0.15	3.0	–	–	–	■	190	0.15	3.0	–	–	–	–	–	–
	M9315	0.8	■	300	0.15	3.0	–	–	–	■	285	0.15	3.0	–	–	–	–	–	–
	M9325	0.8	■	280	0.15	3.0	–	–	–	■	265	0.15	3.0	–	–	–	–	–	–
	M9340	0.8	■	250	0.15	3.0	–	–	–	■	–	–	–	–	–	–	–	–	–
LNGX 120510ER-M	M8330	1.0	■	230	0.15	3.0	–	–	–	■	215	0.15	3.0	–	–	–	–	–	–



Suitability and starting values for cutting speed (vc), feed (f) and depth of cut (ap). Refer to our Machining Calculator app for further calculations.

Product	RE (mm)	P			M			K			N			S			H		
		vc (m/min)	f (mm/tooth)	ap (mm)	vc (m/min)	f (mm/tooth)	ap (mm)	vc (m/min)	f (mm/tooth)	ap (mm)	vc (m/min)	f (mm/tooth)	ap (mm)	vc (m/min)	f (mm/tooth)	ap (mm)	vc (m/min)	f (mm/tooth)	ap (mm)

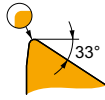

M geometry with positive design for light to medium machining.

LNGX 120512ER-M	M8330	1.2	230	0.15	3.0	—	—	—	215	0.15	3.0	—	—	—	—	—	—	—
	M8340	1.2	210	0.15	3.0	—	—	—	195	0.15	3.0	—	—	—	—	—	—	—
LNGX 120516ER-M	M8330	1.6	240	0.15	3.0	—	—	—	225	0.15	3.0	—	—	—	—	—	—	—
	M8340	1.6	220	0.15	3.0	—	—	—	205	0.15	3.0	—	—	—	—	—	—	—
LNGX 120520ER-M	M8310	2.0	280	0.15	3.0	—	—	—	265	0.15	3.0	—	—	—	—	—	—	—
	M8330	2.0	255	0.15	3.0	—	—	—	240	0.15	3.0	—	—	—	—	—	—	—
	M8340	2.0	230	0.15	3.0	—	—	—	215	0.15	3.0	—	—	—	—	—	—	—

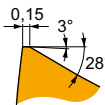

R geometry with positive design for unstable cutting conditions.

LNGX 120508SR-R	8215	0.8	205	0.20	3.5	—	—	—	190	0.20	3.5	—	—	—	—	—	—	—	
	M5315	0.8	265	0.20	3.5	—	—	—	250	0.20	3.5	—	—	—	—	—	—	—	
	M8310	0.8	220	0.20	3.5	—	—	—	205	0.20	3.5	—	—	—	—	—	—	—	
	M8330	0.8	205	0.20	3.5	—	—	—	190	0.20	3.5	—	—	—	—	—	—	—	
	M8340	0.8	185	0.20	3.5	—	—	—	175	0.20	3.5	—	—	—	—	—	—	—	
	M9315	0.8	265	0.20	3.5	—	—	—	250	0.20	3.5	—	—	—	—	—	—	—	—
	M9325	0.8	250	0.20	3.5	—	—	—	235	0.20	3.5	—	—	—	—	—	—	—	—
	M9340	0.8	225	0.20	3.5	—	—	—	—	—	—	—	—	—	—	—	—	—	—
LNGX 120516SR-R	8215	1.6	225	0.20	3.5	—	—	—	210	0.20	3.5	—	—	—	—	—	—	—	
	M8330	1.6	225	0.20	3.5	—	—	—	210	0.20	3.5	—	—	—	—	—	—	—	
	M8340	1.6	205	0.20	3.5	—	—	—	190	0.20	3.5	—	—	—	—	—	—	—	
	M9325	1.6	275	0.20	3.5	—	—	—	260	0.20	3.5	—	—	—	—	—	—	—	

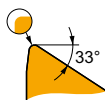

MF geometry with highly positive design for light machining.

LNGX 120504ER-MF	M6330	0.4	175	0.15	1.0	125	0.14	1.0	—	—	—	—	—	—	—	—	—
	M9340	0.4	240	0.15	1.0	140	0.14	1.0	—	—	—	—	—	—	—	—	—
LNGX 120508ER-MF	M6330	0.8	210	0.15	1.0	150	0.14	1.0	—	—	—	—	—	—	—	—	—
	M8340	0.8	225	0.15	1.0	135	0.14	1.0	—	—	—	—	—	—	—	—	—
	M9340	0.8	285	0.15	1.0	170	0.14	1.0	—	—	—	—	—	—	—	—	—

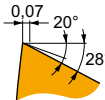

MM geometry with positive design for light to medium machining.

LNGX 120508SR-MM	M6330	0.8	190	0.15	2.8	135	0.14	2.8	—	—	—	—	—	—	—	—	—
	M8340	0.8	200	0.15	2.8	120	0.14	2.8	—	—	—	—	—	—	—	—	—
	M8345	0.8	160	0.15	2.8	95	0.14	2.8	—	—	—	—	—	—	—	—	—
	M9340	0.8	255	0.15	2.8	150	0.14	2.8	—	—	—	—	—	—	—	—	—



LNGU 12



	W1	D1	L	S
	(mm)	(mm)	(mm)	(mm)
1205	9.500	4.50	12.00	5.96

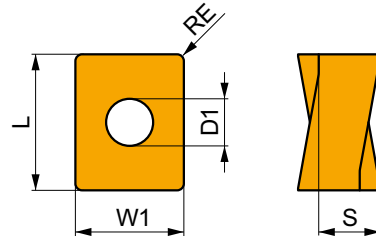

Suitability and starting values for cutting speed (vc), feed (f) and depth of cut (ap). Refer to our Machining Calculator app for further calculations.

Product	RE (mm)	P			M			K			N			S			H		
		vc (m/min)	f (mm/tooth)	ap (mm)	vc (m/min)	f (mm/tooth)	ap (mm)	vc (m/min)	f (mm/tooth)	ap (mm)	vc (m/min)	f (mm/tooth)	ap (mm)	vc (m/min)	f (mm/tooth)	ap (mm)	vc (m/min)	f (mm/tooth)	ap (mm)



M geometry with positive design for medium machining.

LNGU 120525ER-M	M8330	2.5	■	255	0.15	3.0	■	—	—	—	■	240	0.15	3.0	■	—	—	—	■	—	—	—	■	—	—	—
	M8340	2.5	■	230	0.15	3.0	■	—	—	—	■	215	0.15	3.0	■	—	—	—	■	—	—	—	■	—	—	—
LNGU 120530ER-M	M8330	3.0	■	255	0.15	3.0	■	—	—	—	■	240	0.15	3.0	■	—	—	—	■	—	—	—	■	—	—	—
	M8340	3.0	■	230	0.15	3.0	■	—	—	—	■	215	0.15	3.0	■	—	—	—	■	—	—	—	■	—	—	—

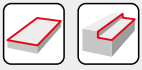

a_s DC	5 %	10 %	15 %	20 %	25 %	30 %	40 %	50 %	60 %	70 %	75 %	80 %	90 %	100 %
	1.48	1.35	1.27	1.22	1.19	1.16	1.11	1.08	1.05	1.03	1.00	1.00	1.00	1.00
	2.20	1.60	1.35	1.20	1.10	0.95	0.85	0.75	0.85	0.95	1.00	1.00	1.00	1.00
	0.64	0.64	0.64	0.64	0.64	0.65	0.65	0.67	0.68	0.71	0.72	0.74	0.79	1.00

	LNGX 12-F	LNGX 12-M						LNGU 12-M		
	0.4	0.8	0.4	0.8	1.0	1.2	1.6	2.0	2.5	3.0
	2.29	1.89	2.29	1.89	1.69	1.49	1.09	0.68	0.87	0.36

	LNGX 12-R	LNGX 12-MF		LNGX 12-MM	
	0.8	1.6	0.4	0.8	0.8
	1.88	1.08	2.28	1.88	1.88

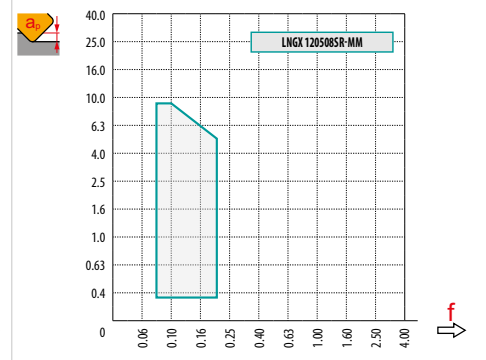
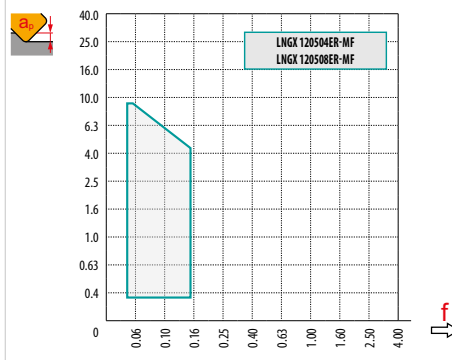
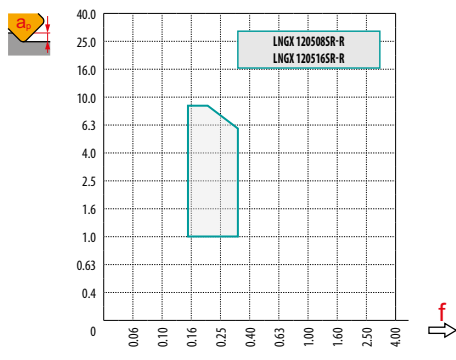
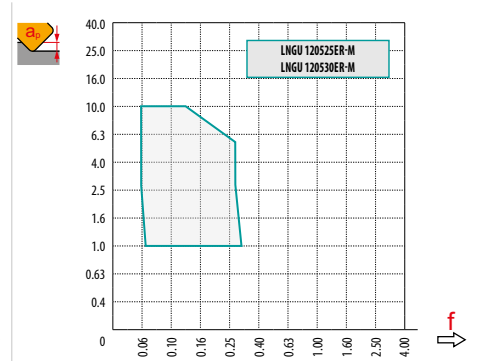
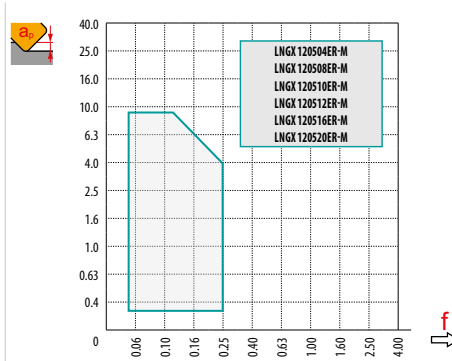
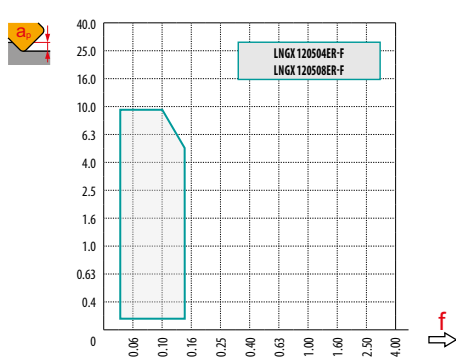

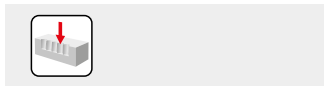

3.5

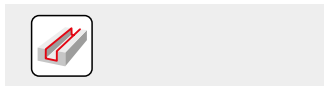

	1.0	5.0	9.0
	0.19	0.13	0.08

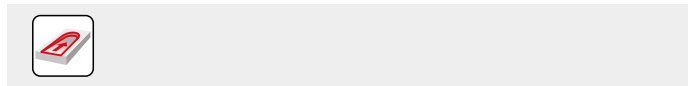

LNGX 12		
	RPMX	APMX/I
25	1.3	2.1/100
32	0.7	1.1/100
40	0.5	0.7/100
50	0.4	0.5/100
63	0.2	0.3/100
80	0.2	0.2/100

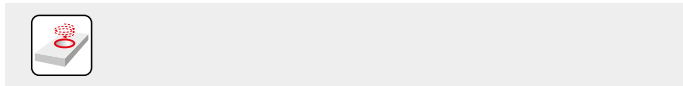

LNGX 12				
	DMIN	DMAX		
			DMIN	DMAX
25	35.0	50.0	0.7	1.7
32	49.0	64.0	0.6	1.2
40	65.0	80.0	0.6	1.0
50	85.0	100.0	0.7	1.0
63	111.0	126.0	0.6	0.8
80	145.0	160.0	0.7	0.8

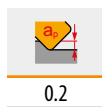
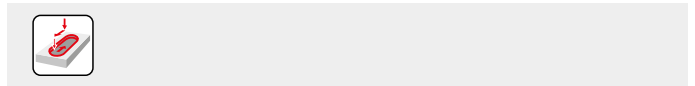

0.2

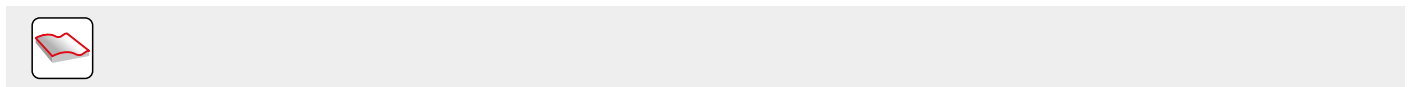

		3	5	10	15	20	30	40	50	60	80	100
25		0.548	0.707	1.000	1.225	1.414	1.732	2.000	2.236	2.449	2.828	3.162
32		0.620	0.800	1.131	1.386	1.600	1.960	2.263	2.530	2.771	3.200	3.578
40		0.693	0.894	1.265	1.549	1.789	2.191	2.530	2.828	3.098	3.578	4.000
50		0.775	1.000	1.414	1.732	2.000	2.449	2.828	3.162	3.464	4.000	4.472
63		0.869	1.122	1.587	1.944	2.245	2.750	3.175	3.550	3.888	4.490	5.020
80	0.980	1.265	1.789	2.191	2.530	3.098	3.578	4.000	4.382	5.060	5.657	

		3	5	10	15	20	30	40	50	60	80	100
1.6		0.196	0.253	0.358	0.438	0.506	0.620	0.716	0.800	0.876	1.012	1.131
2.0		0.219	0.283	0.400	0.490	0.566	0.693	0.800	0.894	0.980	1.131	1.265
2.5		0.245	0.316	0.447	0.548	0.632	0.775	0.894	1.000	1.095	1.265	1.414
3.0		0.268	0.346	0.490	0.600	0.693	0.849	0.980	1.095	1.200	1.386	1.549



SLN16

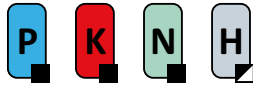

PRAMET



ECON LN16 Square Shoulder Mill with Internal Coolant

90° shell mill utilising double sided LN.. 16 inserts with APMX of 13 mm. Suitable for a wide range of applications. Available in arbor style in Ø63 up to Ø175 mm with differential tooth pitch. Body treated for longer tool life.

ECON LN

KAPR	90°
APMX	13.0 mm

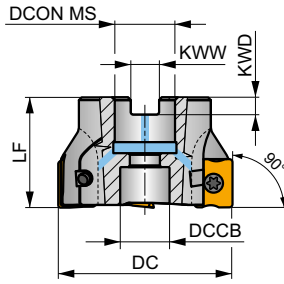
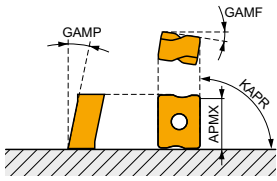

DC 63 – 140 mm

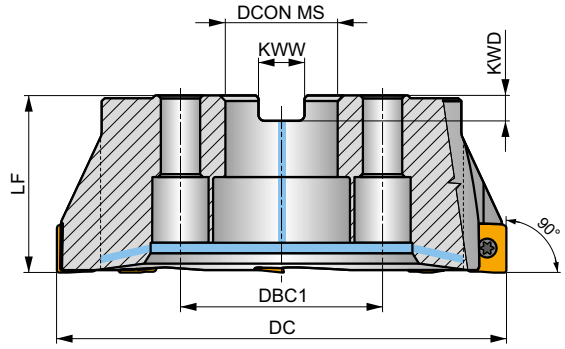

DC 160 – 175 mm

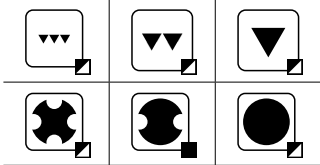

Product	DC (mm)	LF (mm)	DCON MS (mm)	DCCB (mm)	DBC1 (mm)	KWW (mm)	KWD (mm)	GAMF (°)	GAMP (°)	max.	kg	GI207	SQ351	SQ353	AC001	AC002	AC003	
63A04R-S90LN16-C	63	40	22	18	-	10.4	6.3	-10.5	-6	4	✓	7600	✓	0.46	GI207	SQ353	-	-
63A05R-S90LN16-C	63	40	22	18	-	10.4	6.3	-10.5	-6	5	✓	7600	✓	0.46	GI207	SQ353	-	-
80A04R-S90LN16-C	80	50	27	38	-	12.4	7	-10.5	-6	4	✓	6800	✓	0.98	GI207	SQ351	AC001	-
80A06R-S90LN16-C	80	50	27	38	-	12.4	7	-10.5	-6	6	✓	6800	✓	0.89	GI207	SQ351	AC001	-
100A05R-S90LN16-C	100	50	32	45	-	14.4	8	-10.5	-6	5	✓	6100	✓	0.98	GI207	SQ351	AC002	-
100A07R-S90LN16-C	100	50	32	45	-	14.4	8	-10.5	-6	7	✓	6100	✓	1.84	GI207	SQ351	AC002	-
125A06R-S90LN16-C	125	63	40	56	-	16.4	9	-10.5	-6	6	✓	5400	✓	3.44	GI207	SQ351	AC003	-
125A08R-S90LN16-C	125	63	40	56	-	16.4	9	-10.5	-6	8	✓	5400	✓	3.33	GI207	SQ351	AC003	-
140A06R-S90LN16-C	140	63	40	56	-	16.4	9	-10.5	-6	6	✓	5100	✓	3.91	GI207	SQ351	AC003	-
160C08R-S90LN16-C	160	63	40	-	66.7	16.4	9	-10.5	-6	8	✓	4700	✓	6.19	GI207	SQ356	-	-
175C08R-S90LN16-C	175	63	40	-	66.7	16.4	9	-10.5	-6	8	✓	4500	✓	7.11	GI207	SQ356	-	-

GI207	LNMU 1607..	LNGU 1607..
-------	-------------	-------------

SQ351	US 45012-T20P	5.0	M 5	12	SDR T20P-T	-	-	-	-
SQ353	US 45012-T20P	5.0	M 5	12	SDR T20P-T	HS 1030C	-	-	-
SQ356	US 45012-T20P	5.0	M 5	12	SDR T20P-T	HS 1240C	CAC 160C	HSD 0825C	HXK 5



AC001	KS 1230	K.FMH27
AC002	KS 1635	K.FMH32
AC003	KS 2040	K.FMH40

LNMU 16



	W1	D1	L	S
	(mm)	(mm)	(mm)	(mm)
1607	13.200	5.70	16.60	7.50

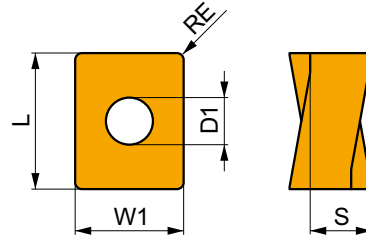

Suitability and starting values for cutting speed (vc), feed (f) and depth of cut (ap). Refer to our Machining Calculator app for further calculations.

Product	RE (mm)	P			M			K			N			S			H		
		vc (m/min)	f (mm/tooth)	ap (mm)	vc (m/min)	f (mm/tooth)	ap (mm)	vc (m/min)	f (mm/tooth)	ap (mm)	vc (m/min)	f (mm/tooth)	ap (mm)	vc (m/min)	f (mm/tooth)	ap (mm)	vc (m/min)	f (mm/tooth)	ap (mm)



F geometry with highly positive design for light machining.

LNMU 160708ER-F	M8330	0.8	230	0.16	1.7	–	–	–	–	–	–	–	–	–	–	–	–	–
	M8340	0.8	210	0.16	1.7	–	–	–	–	–	–	–	–	–	–	–	–	–

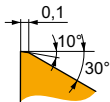

M geometry with positive design for medium machining.

LNMU 160708SR-M	8215	0.8	200	0.18	5.0	–	–	–	190	0.18	5.0	–	–	–	–	–	–	–
	M6330	0.8	170	0.18	5.0	–	–	–	–	–	–	–	–	–	–	–	–	–
	M8330	0.8	200	0.18	5.0	–	–	–	190	0.18	5.0	–	–	–	–	–	–	–
	M8340	0.8	180	0.18	5.0	–	–	–	170	0.18	5.0	–	–	–	–	–	–	–
	M9325	0.8	250	0.18	5.0	–	–	–	235	0.18	5.0	–	–	–	–	–	–	–
LNMU 160720SR-M	M8330	2.0	230	0.18	5.0	–	–	–	215	0.18	5.0	–	–	–	–	–	–	–
	M8340	2.0	210	0.18	5.0	–	–	–	195	0.18	5.0	–	–	–	–	–	–	–
LNMU 160730SR-M	M8330	3.0	230	0.18	5.0	–	–	–	215	0.18	5.0	–	–	–	–	–	–	–
	M8340	3.0	210	0.18	5.0	–	–	–	195	0.18	5.0	–	–	–	–	–	–	–
LNMU 160740SR-M	M8340	4.0	210	0.18	5.0	–	–	–	195	0.18	5.0	–	–	–	–	–	–	–

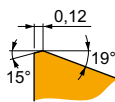

R geometry with positive stable design for medium machining.

LNMU 160708SR-R	M5315	0.8	265	0.18	6.3	–	–	–	250	0.18	6.3	–	–	–	50	0.12	1.0
	M8330	0.8	195	0.18	6.3	–	–	–	185	0.18	6.3	–	–	–	35	0.12	1.0
	M8340	0.8	175	0.18	6.3	–	–	–	165	0.18	6.3	–	–	–	–	–	–
	M9315	0.8	260	0.18	6.3	–	–	–	245	0.18	6.3	–	–	–	50	0.12	1.0
	M9325	0.8	240	0.18	6.3	–	–	–	225	0.18	6.3	–	–	–	45	0.12	1.0
LNMU 160716SR-R	M8330	1.6	215	0.18	6.3	–	–	–	200	0.18	6.3	–	–	–	40	0.12	1.1
	M8340	1.6	195	0.18	6.3	–	–	–	185	0.18	6.3	–	–	–	–	–	–
	M9315	1.6	285	0.18	6.3	–	–	–	270	0.18	6.3	–	–	–	55	0.12	1.1
	M9325	1.6	265	0.18	6.3	–	–	–	250	0.18	6.3	–	–	–	50	0.12	1.1



LNGU 16

	W1	D1	L	S
	(mm)	(mm)	(mm)	(mm)
1607	13.200	5.70	16.60	7.50

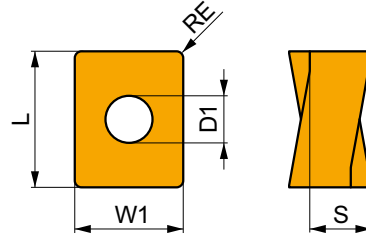

Suitability and starting values for cutting speed (vc), feed (f) and depth of cut (ap). Refer to our Machining Calculator app for further calculations.

Product	RE (mm)	P			M			K			N			S			H		
		vc (m/min)	f (mm/tooth)	ap (mm)	vc (m/min)	f (mm/tooth)	ap (mm)	vc (m/min)	f (mm/tooth)	ap (mm)	vc (m/min)	f (mm/tooth)	ap (mm)	vc (m/min)	f (mm/tooth)	ap (mm)	vc (m/min)	f (mm/tooth)	ap (mm)

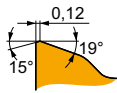

M geometry with highly positive design for medium machining.

LNGU 160708SR-M	8215	0.8	■	200	0.18	5.0	■	–	–	–	■	190	0.18	5.0	■	–	–	–	■	40	0.12	1.0
	M8340	0.8	■	180	0.18	5.0	■	–	–	–	■	170	0.18	5.0	■	–	–	–	■	–	–	–
	M9315	0.8	■	265	0.18	5.0	■	–	–	–	■	250	0.18	5.0	■	–	–	–	■	50	0.12	1.0
	M9325	0.8	■	250	0.18	5.0	■	–	–	–	■	235	0.18	5.0	■	–	–	–	■	50	0.12	1.0

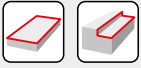

a_e / DC	5 %	10 %	15 %	20 %	25 %	30 %	40 %	50 %	60 %	70 %	75 %	80 %	90 %	100 %
	1.48	1.35	1.27	1.22	1.19	1.16	1.11	1.08	1.05	1.03	1.00	1.00	1.00	1.00
	2.20	1.60	1.35	1.20	1.10	0.95	0.85	0.75	0.85	0.95	1.00	1.00	1.00	1.00
	0.64	0.64	0.64	0.64	0.64	0.65	0.65	0.67	0.68	0.71	0.72	0.74	0.79	1.00

	LNMU 16-F	LNMU 16-M					LNMU 16-R		LNGU 16-M
	0.8	0.8	2.0	3.0	4.0	0.8	1.6	0.8	
	3.30	3.30	2.11	1.12	0.10	3.30	2.50	3.24	

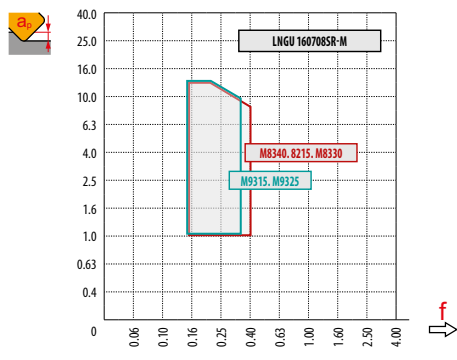
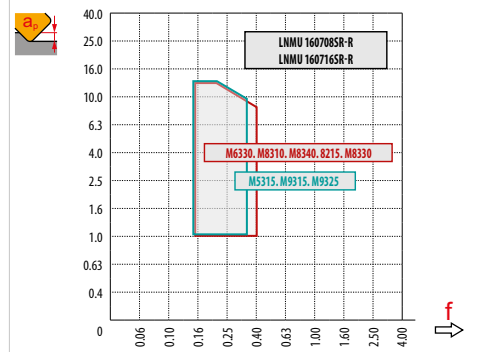
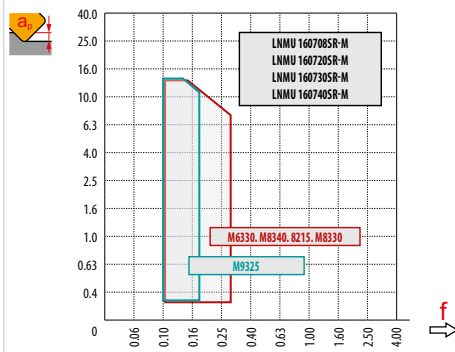
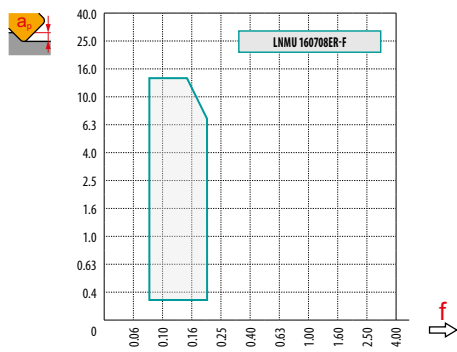

max
7.0

















	1.0	6.0	13.0
	0.31	0.24	0.13



INDEXABLE MILLS – NAVIGATOR

DEEP SHOULDER MILLING



	J(T)-SAD11E		J(T)-SAD16E		J(T)-SLSN		J(T)-SSAP																					
	90°		90°		90°		90°																					
	APMX (mm)	37.0 – 56.0	APMX (mm)	40.0 – 108.0	APMX (mm)	104.0 – 134.0	APMX (mm)	58.0 – 95.0																				
	DC (mm)	25 – 50	DC (mm)	50 – 100	DC (mm)	63 – 80	DC (mm)	50 – 80																				
Weldon			DC = 25 – 40 (mm)																									
Morse taper			DC = 25 – 40 (mm)																									
Arbor					DC = 50 – 80 (mm)																							
Shell mill			DC = 50 (mm)				DC = 50 – 100 (mm)																					
Page	344		349		356		360																					
ISO	P	M	K	N	S	H	P	M	K	N	S	H	P	K			P	M	K	N	S	H						
Insert shape																												
Inserts	AD 11T3		AD.. 1606		LNET 1606 SN.. 1305		APE. 150412 SPE. 1204																					
No. of cutting edges	2		2		2/8		2/4																					
Deep shoulder milling 	■		■		■		■																					
Deep slot milling 	■		■		■		■																					
Face milling 	▣		▣		▣		▣																					
Plunge milling 	▣		▣		▣		▣																					



J(T)-SAD11E

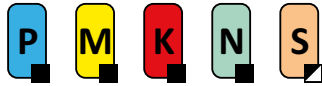

PRAMET

S



HELICAL AD11 Long Edge Mill with Internal Coolant

90° long edge end mill utilising positive ADMX 11 inserts with APMX of 36 up to 56 mm with internal coolant. Suitable for shoulder, slot, face or plunge milling. Available in weldon, morse taper and arbor style in Ø25 up to Ø50 mm. Body treated for longer tool life.

FORCE AD

KAPR	90°
APMX	37.0 - 56.0 mm

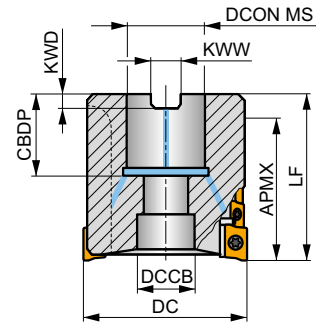
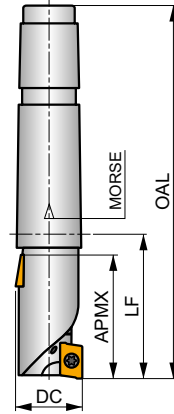
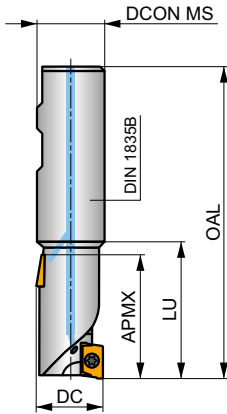
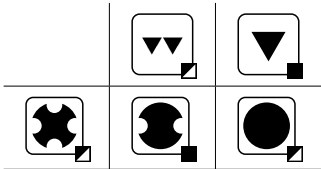
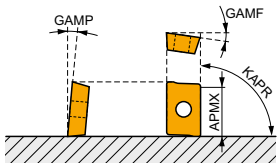

0.05 - 0.08

0.05 - 0.08



Product	DC (mm)	OAL (mm)	DCON MS (mm)	DCCB (mm)	LU (mm)	LF (mm)	APMX (mm)	CBDP (mm)	CZC MS	GAMF (°)	GAMP (°)	NOF											
25J2R50B25-SAD11E38-C	25	106	25	-	50	-	38.00	-	-	-10.5	5	2	8	-	24100	✓	0.32	G184	SQ210				
32J2R60B32-SAD11E47-C	32	120	32	-	60	-	47.00	-	-	-9	8	2	10	-	21300	✓	0.60	G184	SQ210				
40J2R60B40-SAD11E47-C	40	130	40	-	60	-	47.00	-	-	-8.1	11	2	10	-	19100	✓	1.12	G184	SQ210				
40J3R70B32-SAD11E56-C	40	130	32	-	70	-	56.00	-	-	-8.1	11	3	18	-	19100	✓	0.76	G184	SQ210				
40J3R70B40-SAD11E56-C	40	140	40	-	70	-	56.00	-	-	-8.1	11	3	18	-	19100	✓	1.12	G184	SQ210				
25J2R55E03-SAD11E38-C	25	136	-	-	-	55	38.00	-	3	-10.5	5	2	8	-	24100	✓	0.38	G184	SQ210				
32J2R65E04-SAD11E47-C	32	167.5	-	-	-	65	47.00	-	4	-9	8	2	10	-	21300	✓	0.72	G184	SQ210				
40J3R75E04-SAD11E56-C	40	177.5	-	-	-	75	56.00	-	4	-8.1	11	3	18	-	19100	✓	0.85	G184	SQ210				
50T03R-S90AD11E37-C	50	-	22	18	-	58	37.00	21	-	-7.2	12	3	12	-	17000	✓	0.67	G184	SQ903				

G184	ADMX 11T3..	ADEX 11T3...-FA

SQ210	US 2506-T07P	1.2	M 2.5	6.3	-	-	Flag T07P	-
SQ903	US 2506-T07P	1.2	M 2.5	6.3	D-T07P/T09P	FG-15	-	HS 1030C



ADMX 11



	W1	D1	L	S
	(mm)	(mm)	(mm)	(mm)
11T3	6.530	2.90	11.00	3.97

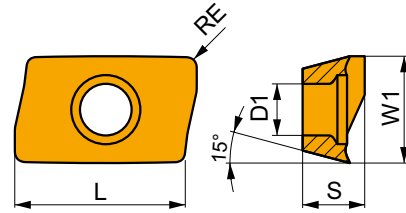

Suitability and starting values for cutting speed (vc), feed (f) and depth of cut (ap). Refer to our Machining Calculator app for further calculations.

Product	RE	P			M			K			N			S			H		
		vc	f	ap	vc	f	ap	vc	f	ap	vc	f	ap	vc	f	ap	vc	f	ap
	(mm)	(m/min)	(mm/tooth)	(mm)	(m/min)	(mm/tooth)	(mm)	(m/min)	(mm/tooth)	(mm)	(m/min)	(mm/tooth)	(mm)	(m/min)	(mm/tooth)	(mm)	(m/min)	(mm/tooth)	(mm)

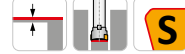
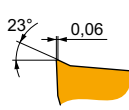
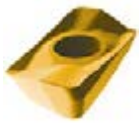

F geometry with very sharp positive design for light machining.

ADMX 11T304SR-F	8215	0.4	245	0.10	2.0	145	0.09	2.0	230	0.10	2.0	735	0.12	2.0	60	0.08	1.6	-	-	-
	M8330	0.4	240	0.10	2.0	140	0.09	2.0	225	0.10	2.0	720	0.12	2.0	60	0.08	1.6	-	-	-
	M8340	0.4	220	0.10	2.0	130	0.09	2.0	205	0.10	2.0	-	-	-	55	0.08	1.6	-	-	-
	M9340	0.4	285	0.10	2.0	170	0.09	2.0	-	-	-	-	-	-	70	0.08	1.6	-	-	-
ADMX 11T308SR-F	8215	0.8	290	0.10	2.0	170	0.09	2.0	275	0.10	2.0	870	0.12	2.0	70	0.08	1.6	-	-	-
	M8330	0.8	285	0.10	2.0	170	0.09	2.0	270	0.10	2.0	855	0.12	2.0	70	0.08	1.6	-	-	-
	M8340	0.8	260	0.10	2.0	155	0.09	2.0	245	0.10	2.0	-	-	-	65	0.08	1.6	-	-	-
	M9340	0.8	340	0.10	2.0	200	0.09	2.0	-	-	-	-	-	-	85	0.08	1.6	-	-	-

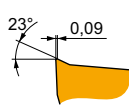

M geometry with positive design for light to medium machining.

ADMX 11T302SR-M	M8330	0.2	190	0.15	4.0	110	0.14	4.0	180	0.15	4.0	-	-	-	45	0.12	3.2	-	-	-
	M8340	0.2	170	0.15	4.0	100	0.14	4.0	160	0.15	4.0	-	-	-	40	0.12	3.2	-	-	-
ADMX 11T304SR-M	8215	0.4	205	0.15	4.0	120	0.14	4.0	190	0.15	4.0	-	-	-	50	0.12	3.2	-	-	-
	M8310	0.4	220	0.15	4.0	110	0.14	4.0	205	0.15	4.0	-	-	-	-	-	-	-	-	-
	M8330	0.4	205	0.15	4.0	120	0.14	4.0	190	0.15	4.0	-	-	-	50	0.12	3.2	-	-	-
	M8340	0.4	185	0.15	4.0	110	0.14	4.0	175	0.15	4.0	-	-	-	45	0.12	3.2	-	-	-
	M9325	0.4	255	0.15	4.0	-	-	-	240	0.15	4.0	-	-	-	-	-	-	-	-	-
ADMX 11T308SR-M	M9340	0.4	235	0.15	4.0	140	0.14	4.0	-	-	-	-	-	-	55	0.12	3.2	-	-	-
	8215	0.8	245	0.15	4.0	145	0.14	4.0	230	0.15	4.0	-	-	-	60	0.12	3.2	-	-	-
	M5315	0.8	335	0.15	4.0	-	-	-	315	0.15	4.0	-	-	-	-	-	-	-	-	-
	M8310	0.8	265	0.15	4.0	135	0.14	4.0	250	0.15	4.0	-	-	-	-	-	-	-	-	-
	M8330	0.8	245	0.15	4.0	145	0.14	4.0	230	0.15	4.0	-	-	-	60	0.12	3.2	-	-	-
	M8340	0.8	220	0.15	4.0	130	0.14	4.0	205	0.15	4.0	-	-	-	55	0.12	3.2	-	-	-
	M9315	0.8	330	0.15	4.0	-	-	-	310	0.15	4.0	-	-	-	-	-	-	-	-	-
ADMX 11T310SR-M	M9325	0.8	305	0.15	4.0	-	-	-	285	0.15	4.0	-	-	-	-	-	-	-	-	-
	M9340	0.8	275	0.15	4.0	165	0.14	4.0	-	-	-	-	-	-	65	0.12	3.2	-	-	-
ADMX 11T312SR-M	M8330	1.0	255	0.15	4.0	150	0.14	4.0	240	0.15	4.0	-	-	-	60	0.12	3.2	-	-	-
	M8340	1.0	230	0.15	4.0	135	0.14	4.0	215	0.15	4.0	-	-	-	55	0.12	3.2	-	-	-
ADMX 11T316SR-M	8215	1.2	255	0.15	4.0	150	0.14	4.0	240	0.15	4.0	-	-	-	60	0.12	3.2	-	-	-
	M8330	1.2	255	0.15	4.0	150	0.14	4.0	240	0.15	4.0	-	-	-	60	0.12	3.2	-	-	-
	M8340	1.2	230	0.15	4.0	135	0.14	4.0	215	0.15	4.0	-	-	-	55	0.12	3.2	-	-	-
ADMX 11T320SR-M	8215	1.6	270	0.15	4.0	160	0.14	4.0	255	0.15	4.0	-	-	-	65	0.12	3.2	-	-	-
	M6330	1.6	230	0.15	4.0	165	0.14	4.0	-	-	-	-	-	65	0.12	3.2	-	-	-	
	M8310	1.6	295	0.15	4.0	150	0.14	4.0	280	0.15	4.0	-	-	-	-	-	-	-	-	
	M8330	1.6	270	0.15	4.0	160	0.14	4.0	255	0.15	4.0	-	-	-	65	0.12	3.2	-	-	-
	M8340	1.6	240	0.15	4.0	140	0.14	4.0	225	0.15	4.0	-	-	-	60	0.12	3.2	-	-	-
ADMX 11T320SR-M	M6330	2.0	240	0.15	4.0	170	0.14	4.0	-	-	-	-	-	70	0.12	3.2	-	-	-	
	M8330	2.0	280	0.15	4.0	165	0.14	4.0	265	0.15	4.0	-	-	-	70	0.12	3.2	-	-	-
	M8340	2.0	255	0.15	4.0	150	0.14	4.0	240	0.15	4.0	-	-	-	60	0.12	3.2	-	-	-



Suitability and starting values for cutting speed (vc), feed (f) and depth of cut (ap). Refer to our Machining Calculator app for further calculations.

Product	RE (mm)	P			M			K			N			S			H		
		vc (m/min)	f (mm/tooth)	ap (mm)	vc (m/min)	f (mm/tooth)	ap (mm)	vc (m/min)	f (mm/tooth)	ap (mm)	vc (m/min)	f (mm/tooth)	ap (mm)	vc (m/min)	f (mm/tooth)	ap (mm)	vc (m/min)	f (mm/tooth)	ap (mm)

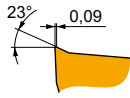

M geometry with positive design for light to medium machining.

ADMX 11T325SR-M	M6330	2.5	240	0.15	4.0	170	0.14	4.0	–	–	–	–	–	–	70	0.12	3.2	–	–	–
	M8340	2.5	255	0.15	4.0	150	0.14	4.0	240	0.15	4.0	–	–	–	60	0.12	3.2	–	–	–
ADMX 11T330SR-M	M6330	3.0	240	0.15	4.0	170	0.14	4.0	–	–	–	–	–	70	0.12	3.2	–	–	–	
	M8330	3.0	280	0.15	4.0	165	0.14	4.0	265	0.15	4.0	–	–	–	70	0.12	3.2	–	–	–
	M8340	3.0	255	0.15	4.0	150	0.14	4.0	240	0.15	4.0	–	–	–	60	0.12	3.2	–	–	–

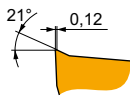
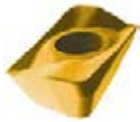

R geometry with positive design for machining conditions in less stable conditions.

ADMX 11T308PR-R	8215	0.8	230	0.18	4.0	135	0.16	4.0	215	0.18	4.0	–	–	–	55	0.16	3.2	45	0.12	0.7
	M5315	0.8	310	0.18	4.0	–	–	–	290	0.18	4.0	–	–	–	–	–	–	60	0.13	0.7
	M8310	0.8	250	0.18	4.0	125	0.16	4.0	235	0.18	4.0	–	–	–	–	–	–	50	0.12	0.7
	M8330	0.8	230	0.18	4.0	135	0.16	4.0	215	0.18	4.0	–	–	–	55	0.16	3.2	45	0.12	0.7
	M8340	0.8	210	0.18	4.0	125	0.16	4.0	195	0.18	4.0	–	–	–	50	0.16	3.2	–	–	–
	M9315	0.8	310	0.18	4.0	–	–	–	290	0.18	4.0	–	–	–	–	–	–	60	0.13	0.7
	M9325	0.8	290	0.18	4.0	–	–	–	275	0.18	4.0	–	–	–	–	–	–	55	0.13	0.7
ADMX 11T316PR-R	8215	1.6	255	0.18	4.0	150	0.16	4.0	240	0.18	4.0	–	–	–	60	0.16	3.2	50	0.12	0.7
	M8330	1.6	255	0.18	4.0	150	0.16	4.0	240	0.18	4.0	–	–	–	60	0.16	3.2	50	0.12	0.7
	M9325	1.6	320	0.18	4.0	–	–	–	300	0.18	4.0	–	–	–	–	–	–	60	0.12	0.7

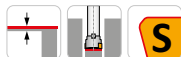
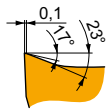

MF geometry with highly positive design for light to finish machining.

ADMX 11T304SR-MF	M6330	0.4	215	0.08	2.5	150	0.07	2.5	–	–	–	–	–	–	60	0.06	2.0	–	–	–
	M8340	0.4	220	0.08	2.5	130	0.07	2.5	–	–	–	–	–	–	55	0.06	2.0	–	–	–
ADMX 11T308SR-MF	M6330	0.8	255	0.08	2.5	180	0.07	2.5	–	–	–	–	–	–	75	0.06	2.0	–	–	–
	M8340	0.8	265	0.08	2.5	155	0.07	2.5	–	–	–	–	–	–	65	0.06	2.0	–	–	–

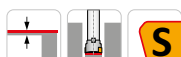
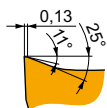

MM geometry with highly positive design for light to medium machining.

ADMX 11T304SR-MM	M6330	0.4	185	0.14	2.5	130	0.13	2.5	–	–	–	–	–	–	55	0.11	2.0	–	–	–
	M8340	0.4	195	0.14	2.5	115	0.13	2.5	–	–	–	–	–	–	45	0.11	2.0	–	–	–
ADMX 11T308SR-MM	M6330	0.8	225	0.14	2.5	155	0.13	2.5	–	–	–	–	–	–	65	0.11	2.0	–	–	–
	M8340	0.8	235	0.14	2.5	140	0.13	2.5	–	–	–	–	–	–	55	0.11	2.0	–	–	–
	M8345	0.8	190	0.14	2.5	110	0.13	2.5	–	–	–	–	–	–	45	0.11	2.0	–	–	–
	M9340	0.8	300	0.14	2.5	180	0.13	2.5	–	–	–	–	–	–	75	0.11	2.0	–	–	–
ADMX 11T312SR-MM	M6330	1.2	235	0.14	2.5	165	0.13	2.5	–	–	–	–	–	–	70	0.11	2.0	–	–	–
	M8340	1.2	245	0.14	2.5	145	0.13	2.5	–	–	–	–	–	–	60	0.11	2.0	–	–	–



ADEX 11-HF

	W1	D1	L	S
	(mm)	(mm)	(mm)	(mm)
11T3	6.450	2.90	10.67	3.82

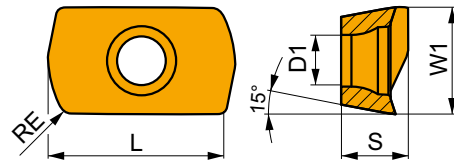

Suitability and starting values for cutting speed (vc), feed (f) and depth of cut (ap). Refer to our Machining Calculator app for further calculations.

Product	RE (mm)	P			M			K			N			S			H		
		vc (m/min)	f (mm/tooth)	ap (mm)	vc (m/min)	f (mm/tooth)	ap (mm)	vc (m/min)	f (mm/tooth)	ap (mm)	vc (m/min)	f (mm/tooth)	ap (mm)	vc (m/min)	f (mm/tooth)	ap (mm)	vc (m/min)	f (mm/tooth)	ap (mm)

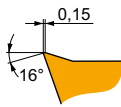

HF geometry with highly positive design for high feed machining.

Product	RE	vc	f	ap	vc	f	ap	vc	f	ap	vc	f	ap	vc	f	ap
ADEX 11T308SR-HF	0.8	215	0.68	0.4	125	0.61	0.4	-	-	-	-	-	-	-	-	-
M8215	0.8	215	0.68	0.4	125	0.61	0.4	-	-	-	-	-	-	-	-	-
M6330	0.8	185	0.68	0.4	130	0.61	0.4	-	-	-	-	-	-	-	-	-
M8310	0.8	220	0.68	0.4	110	0.52	0.4	-	-	-	-	-	-	-	-	-
M8330	0.8	215	0.68	0.4	125	0.61	0.4	-	-	-	-	-	-	-	-	-
M8340	0.8	200	0.68	0.4	120	0.61	0.4	-	-	-	-	-	-	-	-	-
M9340	0.8	220	0.68	0.4	130	0.61	0.4	-	-	-	-	-	-	-	-	-

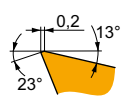

HF2 geometry with positive design for high feed machining.

Product	RE	vc	f	ap	vc	f	ap	vc	f	ap	vc	f	ap	vc	f	ap
ADEX 11T308SR-HF2	0.8	220	0.68	0.4	110	0.61	0.4	205	0.68	0.4	-	-	-	-	-	-
M8310	0.8	220	0.68	0.4	110	0.61	0.4	205	0.68	0.4	-	-	-	40	0.48	0.3
M8330	0.8	215	0.68	0.4	125	0.61	0.4	200	0.68	0.4	50	0.48	0.3	40	0.48	0.3
M8340	0.8	200	0.68	0.4	120	0.61	0.4	190	0.68	0.4	50	0.48	0.3	-	-	-
M9325	0.8	250	0.68	0.4	-	-	-	235	0.68	0.4	-	-	-	50	0.48	0.3



a_e / DC	5 %	10 %	15 %	20 %	25 %	30 %	40 %	50 %	60 %	70 %	75 %	80 %	90 %	100 %
	0.89	0.81	0.76	0.73	0.71	0.70	0.67	0.65	0.63	0.62	0.60	0.60	0.60	0.45



	1		2.5		5		7.5		10		15		20	
	f_{min}	f_{max}	f_{min}	f_{max}	f_{min}	f_{max}	f_{min}	f_{max}	f_{min}	f_{max}	f_{min}	f_{max}	f_{min}	f_{max}
25	0.25	0.40	0.16	0.26	0.12	0.19	0.10	0.15	0.09	0.14	0.07	0.12	0.07	0.11
32	0.28	0.45	0.18	0.29	0.13	0.21	0.11	0.17	0.09	0.15	0.08	0.13	0.07	0.12
40	0.32	0.51	0.20	0.32	0.14	0.23	0.12	0.19	0.10	0.17	0.09	0.14	0.08	0.13
50	0.35	0.57	0.23	0.36	0.16	0.26	0.13	0.21	0.12	0.19	0.10	0.15	0.09	0.14

	25		32		40		50	
	f_{min}	f_{max}	f_{min}	f_{max}	f_{min}	f_{max}	f_{min}	f_{max}
25	0.08	0.13	-	-	-	-	-	-
32	0.07	0.11	0.08	0.13	-	-	-	-
40	0.07	0.12	0.07	0.11	0.08	0.13	-	-
50	0.08	0.13	0.07	0.12	0.07	0.11	0.08	0.13

	ADMX 11-F		ADMX 11-M									ADMX 11-R		ADMX 11-MF		ADMX 11-MM		
RE	0.4	0.8	0.2	0.4	0.8	1.0	1.2	1.6	2.0	2.5	3.0	0.8	1.6	0.4	0.8	0.4	0.8	1.2
BS	1.89	1.48	2.09	1.89	1.48	1.27	1.08	0.68	1.61	1.13	0.66	1.48	0.68	1.89	1.48	1.89	1.48	1.08



ISO					
25J2R50B25-SAD11E38-C	25	2	38	34.5	4.5
32J2R60B32-SAD11E47-C	32	2	47	43.5	
40J2R60B40-SAD11E47-C	40	2	47	43.5	
40J3R70B32-SAD11E56-C	40	3	56	52.5	
40J3R70B40-SAD11E56-C	40	3	56	52.5	
25J2R55E03-SAD11E38-C	25	2	38	34.5	
32J2R65E04-SAD11E47-C	32	2	47	43.5	
40J3R75E04-SAD11E56-C	40	3	56	52.5	
50T03R-S90AD11E37-C	50	3	37	33.5	

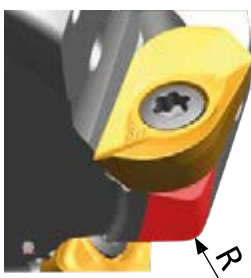

ADMX/ADEX 11	R
ADMX 11T320SR-M	1.0
ADMX 11T325SR-M	1.8
ADMX 11T330SR-M	1.8



J(T)-SAD16E

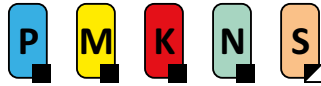

PRAMET

S



HELICAL AD16 Long Edge Mill with Internal Coolant

90° long edge end mill utilising positive AD.. 16 inserts with APMX of 40 up to 108 mm with internal coolant. Suitable for shoulder, slot, face or plunge milling. Available in arbor, DIN 69871, BT and DIN 2080 taper style, in Ø50 up to Ø100 mm, with or without differential tooth pitch. Body treated for longer tool life.

FORCE AD

KAPR	90°
APMX	40.0 - 108.0 mm

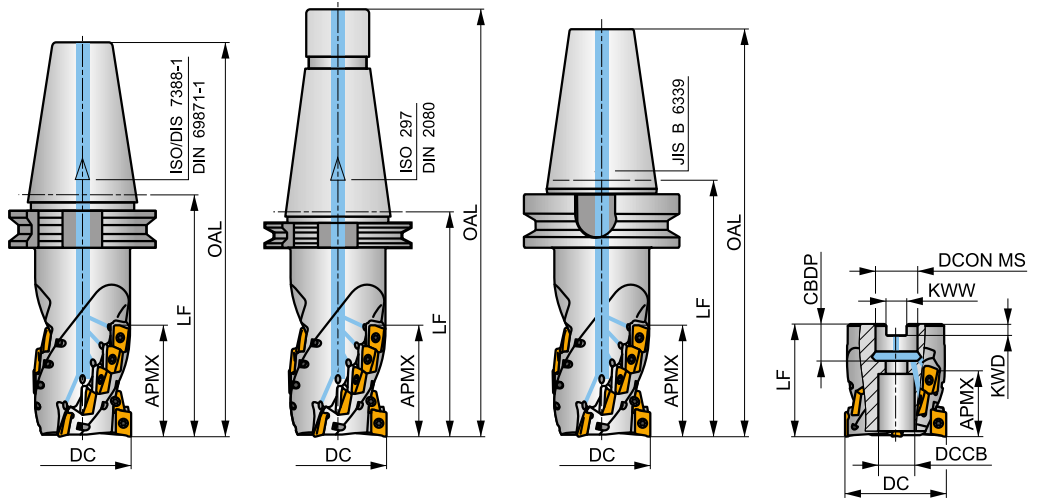
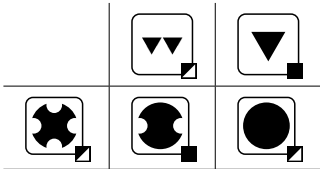
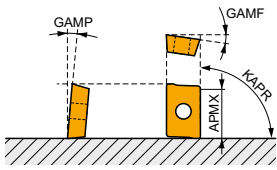

	0.08 - 0.1
	0.08 - 0.1

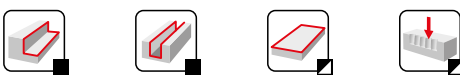

Product	DC	OAL	DCON MS	DCCB	LU	LF	APMX	CBDP	CZC MS	GAMF	GAMP	NOF						
	(mm)	(mm)	(mm)	(mm)	(mm)	(mm)	(mm)	(mm)	(mm)	(°)	(°)							
50J3R100H50-SAD16E54-C	50	202	-	-	-	100	54.00	-	50	-6	12	3	-	13200	✓	4.08	GI282 SQ031	
50J3R140H50-SAD16E80-C	50	242	-	-	-	140	80.00	-	50	-6	12	3	18	13200	✓	4.38	GI282 SQ031	
63J3R140H50-SAD16E68-C	63	242	-	-	-	140	68.00	-	50	-6	12	3	15	11700	✓	5.34	GI282 SQ031	
63J3R155H50-SAD16E95-C	63	257	-	-	-	155	95.00	-	50	-6	12	3	21	11700	✓	5.43	GI282 SQ031	
80J4R165H50-SAD16E108-C	80	257	-	-	-	165	108.00	-	50	-6	12	4	32	10400	✓	7.37	GI282 SQ031	
50J3R140G50-SAD16E80-C	50	267	-	-	-	140	80.00	-	50	-6	12	3	18	13200	✓	4.48	GI282 SQ031	
63J3R155G50-SAD16E95-C	63	282	-	-	-	155	95.00	-	50	-6	12	3	21	11700	✓	5.52	GI282 SQ031	
80J4R165G50-SAD16E108-C	80	292	-	-	-	165	108.00	-	50	-6	12	4	32	10400	✓	7.51	GI282 SQ031	
50J3R140X50-SAD16E68-C	50	242	-	-	-	140	68.00	-	50	-6	12	3	15	13200	✓	5.28	GI282 SQ031	
63J3R155X50-SAD16E80-C	63	257	-	-	-	155	80.00	-	50	-6	12	3	18	11700	✓	6.19	GI282 SQ031	
80J4R165X50-SAD16E95-C	80	267	-	-	-	165	95.00	-	50	-6	12	4	28	10400	✓	7.84	GI282 SQ031	
50T03R-S90AD16E40-C	50	-	22	18	-	70	40.00	21	-	-6	12	3	9	13200	✓	1.11	GI282 SQ913	
63T04R-S90AD16E40-C	63	-	27	22	-	70	40.00	22	-	-6	12	4	12	11700	✓	1.50	GI282 SQ914	
63T04R-S90AD16E68-C	63	-	27	22	-	100	68.00	22	-	-6	12	4	20	11700	✓	1.86	GI282 SQ914	
80T04R-S90AD16E55-C	80	-	32	30	-	85	55.00	25	-	-6	12	4	16	10400	✓	2.56	GI282 SQ915	
80T04R-S90AD16E80-C	80	-	32	30	-	115	80.00	25	-	-6	12	4	24	10400	✓	3.17	GI282 SQ915	
100T05R-S90AD16E80-C	100	-	40	36	-	120	80.00	30	-	-6	12	5	30	9300	✓	5.73	GI282 SQ916	

GI282	ADMX 1606..	ADEX 1606..-FA
		ADEX 1606..-FM



SQ031	US 4011-T15P	3.5	M 4	10.6	D-T08P/T15P	FG-15	–
SQ913	US 4011-T15P	3.5	M 4	10.6	D-T08P/T15P	FG-15	HS 1030C
SQ914	US 4011-T15P	3.5	M 4	10.6	D-T08P/T15P	FG-15	HS 1230C
SQ915	US 4011-T15P	3.5	M 4	10.6	D-T08P/T15P	FG-15	HS 1630C
SQ916	US 4011-T15P	3.5	M 4	10.6	D-T08P/T15P	FG-15	HS 2040C

ADMX 16



	W1	D1	L	S
	(mm)	(mm)	(mm)	(mm)
1606	9.950	4.50	16.00	6.25

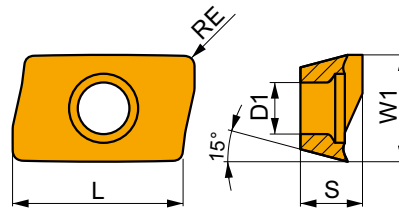

Suitability and starting values for cutting speed (vc), feed (f) and depth of cut (ap). Refer to our Machining Calculator app for further calculations.

Product	RE (mm)	P			M			K			N			S			H		
		vc (m/min)	f (mm/tooth)	ap (mm)	vc (m/min)	f (mm/tooth)	ap (mm)	vc (m/min)	f (mm/tooth)	ap (mm)	vc (m/min)	f (mm/tooth)	ap (mm)	vc (m/min)	f (mm/tooth)	ap (mm)	vc (m/min)	f (mm/tooth)	ap (mm)

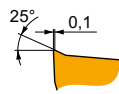

F geometry with highly positive design for light to medium machining.

ADMX 160608SR-F	8215	0.8	290	0.10	2.0	170	0.09	2.0	275	0.10	2.0	870	0.12	2.0	70	0.07	1.6	–	–	–
	M8310	0.8	320	0.10	2.0	160	0.09	2.0	300	0.10	2.0	–	–	–	–	–	–	–	–	–
	M8330	0.8	285	0.10	2.0	170	0.09	2.0	270	0.10	2.0	855	0.12	2.0	70	0.07	1.6	–	–	–
	M8340	0.8	260	0.10	2.0	155	0.09	2.0	245	0.10	2.0	–	–	–	65	0.07	1.6	–	–	–
	M9340	0.8	340	0.10	2.0	200	0.09	2.0	–	–	–	–	–	85	0.07	1.6	–	–	–	

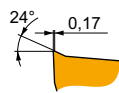

M geometry with positive design for light to medium machining.

ADMX 160604SR-M	8215	0.4	190	0.18	5.0	110	0.16	5.0	180	0.18	5.0	–	–	–	45	0.13	4.0	–	–	–
	M8330	0.4	190	0.18	5.0	110	0.16	5.0	180	0.18	5.0	–	–	–	45	0.13	4.0	–	–	–
	M8340	0.4	170	0.18	5.0	100	0.16	5.0	160	0.18	5.0	–	–	–	40	0.13	4.0	–	–	–
	M9325	0.4	310	0.18	5.0	–	–	–	290	0.18	5.0	–	–	–	–	–	–	–	–	–
ADMX 160608SR-M	8215	0.8	225	0.18	5.0	135	0.16	5.0	210	0.18	5.0	–	–	–	55	0.13	4.0	–	–	–
	M5315	0.8	305	0.18	5.0	–	–	–	285	0.18	5.0	–	–	–	–	–	–	–	–	–
	M8310	0.8	250	0.18	5.0	125	0.16	5.0	235	0.18	5.0	–	–	–	–	–	–	–	–	–
	M8330	0.8	225	0.18	5.0	135	0.16	5.0	210	0.18	5.0	–	–	–	55	0.13	4.0	–	–	–
	M8340	0.8	205	0.18	5.0	120	0.16	5.0	190	0.18	5.0	–	–	–	50	0.13	4.0	–	–	–
ADMX 160616SR-M	8215	1.6	250	0.18	5.0	150	0.16	5.0	235	0.18	5.0	–	–	–	60	0.13	4.0	–	–	–
	M8310	1.6	275	0.18	5.0	140	0.16	5.0	260	0.18	5.0	–	–	–	–	–	–	–	–	–
	M8330	1.6	250	0.18	5.0	150	0.16	5.0	235	0.18	5.0	–	–	–	60	0.13	4.0	–	–	–
	M8340	1.6	225	0.18	5.0	135	0.16	5.0	210	0.18	5.0	–	–	–	55	0.13	4.0	–	–	–
	M9325	1.6	310	0.18	5.0	–	–	–	290	0.18	5.0	–	–	–	–	–	–	–	–	–
ADMX 160620SR-M	M8330	2.0	265	0.18	5.0	155	0.16	5.0	250	0.18	5.0	–	–	–	65	0.13	4.0	–	–	–
	M8340	2.0	240	0.18	5.0	140	0.16	5.0	225	0.18	5.0	–	–	–	60	0.13	4.0	–	–	–
ADMX 160630SR-M	M8330	3.0	265	0.18	5.0	155	0.16	5.0	250	0.18	5.0	–	–	–	65	0.13	4.0	–	–	–
	M8340	3.0	240	0.18	5.0	140	0.16	5.0	225	0.18	5.0	–	–	–	60	0.13	4.0	–	–	–



Suitability and starting values for cutting speed (vc), feed (f) and depth of cut (ap). Refer to our Machining Calculator app for further calculations.

Product	RE (mm)	P			M			K			N			S			H		
		vc (m/min)	f (mm/tooth)	ap (mm)	vc (m/min)	f (mm/tooth)	ap (mm)	vc (m/min)	f (mm/tooth)	ap (mm)	vc (m/min)	f (mm/tooth)	ap (mm)	vc (m/min)	f (mm/tooth)	ap (mm)	vc (m/min)	f (mm/tooth)	ap (mm)

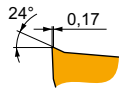

M geometry with positive design for light to medium machining.

ADMX 160632SR-M	M6330	3.2	225	0.18	5.0	155	0.16	5.0	250	0.18	5.0	-	-	-	65	0.13	4.0	-	-	-
	M8330	3.2	265	0.18	5.0	155	0.16	5.0	250	0.18	5.0	-	-	-	65	0.13	4.0	-	-	-
	M8340	3.2	240	0.18	5.0	140	0.16	5.0	225	0.18	5.0	-	-	-	60	0.13	4.0	-	-	-
	M9325	3.2	325	0.18	5.0	-	-	-	305	0.18	5.0	-	-	-	-	-	-	-	-	-
ADMX 160640SR-M	M8330	4.0	265	0.18	5.0	155	0.16	5.0	250	0.18	5.0	-	-	-	65	0.13	4.0	-	-	-
	M8340	4.0	240	0.18	5.0	140	0.16	5.0	225	0.18	5.0	-	-	-	60	0.13	4.0	-	-	-
ADMX 160650SR-M	M8330	5.0	265	0.18	5.0	155	0.16	5.0	250	0.18	5.0	-	-	-	65	0.13	4.0	-	-	-
	M8340	5.0	240	0.18	5.0	140	0.16	5.0	225	0.18	5.0	-	-	-	60	0.13	4.0	-	-	-

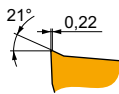

R geometry with positive design for medium to less stable machining conditions.

ADMX 160608PR-R	8215	0.8	205	0.25	6.0	120	0.23	6.0	190	0.25	6.0	-	-	-	50	0.20	4.8	40	0.16	1.1
	M5315	0.8	260	0.25	6.0	-	-	-	245	0.25	6.0	-	-	-	-	-	-	50	0.16	1.1
	M8310	0.8	220	0.25	6.0	110	0.23	6.0	205	0.25	6.0	-	-	-	-	-	-	40	0.16	1.1
	M8330	0.8	205	0.25	6.0	120	0.23	6.0	190	0.25	6.0	-	-	-	50	0.20	4.8	40	0.16	1.1
	M8340	0.8	190	0.25	6.0	110	0.23	6.0	180	0.25	6.0	-	-	-	45	0.20	4.8	-	-	-
	M9315	0.8	265	0.25	6.0	-	-	-	250	0.25	6.0	-	-	-	-	-	-	50	0.16	1.1
	M9325	0.8	250	0.25	6.0	-	-	-	235	0.25	6.0	-	-	-	-	-	-	50	0.16	1.1
ADMX 160616PR-R	M8330	1.6	225	0.25	6.0	135	0.23	6.0	210	0.25	6.0	-	-	-	55	0.20	4.8	45	0.16	1.1
	M8340	1.6	210	0.25	6.0	125	0.23	6.0	195	0.25	6.0	-	-	-	50	0.20	4.8	-	-	-
	M9315	1.6	295	0.25	6.0	-	-	-	280	0.25	6.0	-	-	-	-	-	-	55	0.16	1.1

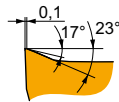

MF geometry with highly positive design for finish machining.

ADMX 160608SR-MF	M6330	0.8	215	0.08	4.0	150	0.07	4.0	-	-	-	-	-	-	60	0.06	3.2	-	-	-
	M8340	0.8	225	0.08	4.0	135	0.07	4.0	-	-	-	-	-	-	55	0.06	3.2	-	-	-
	M9340	0.8	305	0.08	4.0	180	0.07	4.0	-	-	-	-	-	-	75	0.06	3.2	-	-	-

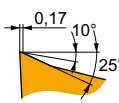

MM geometry with highly positive design for light to medium machining.

ADMX 160604SR-MM	M6330	0.4	145	0.18	4.0	105	0.16	4.0	-	-	-	-	-	-	40	0.14	3.2	-	-	-
	M8340	0.4	160	0.18	4.0	95	0.16	4.0	-	-	-	-	-	-	40	0.14	3.2	-	-	-
ADMX 160608SR-MM	M6330	0.8	175	0.18	4.0	125	0.16	4.0	-	-	-	-	-	-	50	0.14	3.2	-	-	-
	M8340	0.8	190	0.18	4.0	110	0.16	4.0	-	-	-	-	-	-	45	0.14	3.2	-	-	-
	M8345	0.8	150	0.18	4.0	90	0.16	4.0	-	-	-	-	-	-	35	0.14	3.2	-	-	-
	M9340	0.8	235	0.18	4.0	140	0.16	4.0	-	-	-	-	-	-	55	0.14	3.2	-	-	-
ADMX 160616SR-MM	M6330	1.6	195	0.18	4.0	140	0.16	4.0	-	-	-	-	-	-	55	0.14	3.2	-	-	-
	M8340	1.6	210	0.18	4.0	125	0.16	4.0	-	-	-	-	-	-	50	0.14	3.2	-	-	-
	M8345	1.6	165	0.18	4.0	95	0.16	4.0	-	-	-	-	-	-	40	0.14	3.2	-	-	-
	M9340	1.6	260	0.18	4.0	155	0.16	4.0	-	-	-	-	-	-	65	0.14	3.2	-	-	-



ADEX 16

PRAMET

	W1	D1	L	S
	(mm)	(mm)	(mm)	(mm)
1606	9.950	4.50	16.00	6.25

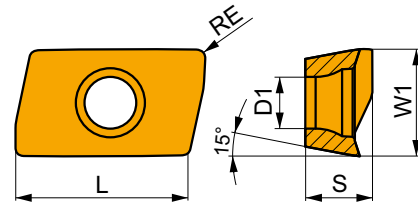

Suitability and starting values for cutting speed (vc), feed (f) and depth of cut (ap). Refer to our Machining Calculator app for further calculations.

Product	RE	P			M			K			N			S			H		
		vc	f	ap	vc	f	ap	vc	f	ap	vc	f	ap	vc	f	ap	vc	f	ap
	(mm)	(m/min)	(mm/tooth)	(mm)	(m/min)	(mm/tooth)	(mm)	(m/min)	(mm/tooth)	(mm)	(m/min)	(mm/tooth)	(mm)	(m/min)	(mm/tooth)	(mm)	(m/min)	(mm/tooth)	(mm)

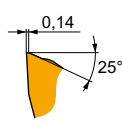

FM geometry with highly positive design for medium machining.

ADEX 160608SR-FM	8215	0.8	■	260	0.16	2.0	☑	155	0.14	2.0	■	245	0.16	2.0	–	–	–	☑	65	0.11	1.6	–	–	–
	M8330	0.8	■	255	0.16	2.0	☑	150	0.14	2.0	■	240	0.16	2.0	–	–	–	☑	60	0.11	1.6	–	–	–
	M8340	0.8	■	235	0.16	2.0	☑	140	0.14	2.0	■	220	0.16	2.0	–	–	–	☑	55	0.11	1.6	–	–	–

ADEX 16-HF

PRAMET

	W1	D1	L	S
	(mm)	(mm)	(mm)	(mm)
1606	9.950	4.50	16.00	5.88

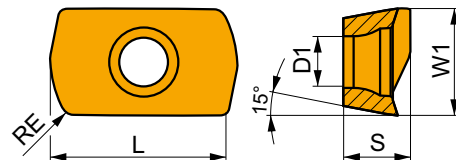

Suitability and starting values for cutting speed (vc), feed (f) and depth of cut (ap). Refer to our Machining Calculator app for further calculations.

Product	RE	P			M			K			N			S			H		
		vc	f	ap	vc	f	ap	vc	f	ap	vc	f	ap	vc	f	ap	vc	f	ap
	(mm)	(m/min)	(mm/tooth)	(mm)	(m/min)	(mm/tooth)	(mm)	(m/min)	(mm/tooth)	(mm)	(m/min)	(mm/tooth)	(mm)	(m/min)	(mm/tooth)	(mm)	(m/min)	(mm/tooth)	(mm)

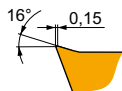

HF geometry with highly positive design for high feed machining.

ADEX 160612SR-HF	8215	1.2	■	195	1.00	0.6	☑	115	0.90	0.6	–	–	–	–	–	–	–	–	–	–	–	–	–
	M8310	1.2	■	205	1.00	0.6	☑	100	0.77	0.6	–	–	–	–	–	–	–	–	–	–	–	–	–
	M8330	1.2	■	200	1.00	0.6	☑	120	0.90	0.6	–	–	–	–	–	–	–	–	–	–	–	–	–
	M8340	1.2	■	185	1.00	0.6	☑	110	0.90	0.6	–	–	–	–	–	–	–	–	–	–	–	–	–
	M9340	1.2	■	195	1.00	0.6	☑	115	0.90	0.6	–	–	–	–	–	–	–	–	–	–	–	–	–



Suitability and starting values for cutting speed (vc), feed (f) and depth of cut (ap). Refer to our Machining Calculator app for further calculations.

Product	RE (mm)	P			M			K			N			S			H		
		vc (m/min)	f (mm/tooth)	ap (mm)	vc (m/min)	f (mm/tooth)	ap (mm)	vc (m/min)	f (mm/tooth)	ap (mm)	vc (m/min)	f (mm/tooth)	ap (mm)	vc (m/min)	f (mm/tooth)	ap (mm)	vc (m/min)	f (mm/tooth)	ap (mm)

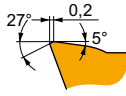

HF2 geometry with positive design for high feed machining.

ADEX 160612SR-HF2	M8310	1.2	■	205	0.90	0.6	☑	100	0.81	0.6	☑	190	0.90	0.6	—	—	—	—	—	—	☑	40	0.63	0.5	
	M8330	1.2	■	205	0.90	0.6	☑	120	0.81	0.6	☑	190	0.90	0.6	—	—	—	☑	50	0.81	0.5	☑	40	0.63	0.5
	M8340	1.2	■	190	0.90	0.6	☑	110	0.81	0.6	☑	180	0.90	0.6	—	—	—	☑	45	0.81	0.5	—	—	—	—
	M9325	1.2	■	230	0.90	0.6	—	—	—	—	☑	215	0.90	0.6	—	—	—	—	—	—	—	☑	45	0.63	0.5



a_s DC	5 %	10 %	15 %	20 %	25 %	30 %	40 %	50 %	60 %	70 %	75 %	80 %	90 %	100 %
	0.89	0.81	0.76	0.73	0.71	0.70	0.66	0.65	0.63	0.62	0.60	0.60	0.60	0.45







	1		2.5		5		7.5		10		15		20	
DC	f_{min}	f_{max}	f_{min}	f_{max}	f_{min}	f_{max}	f_{min}	f_{max}	f_{min}	f_{max}	f_{min}	f_{max}	f_{min}	f_{max}
50	0.57	0.71	0.36	0.45	0.26	0.32	0.21	0.27	0.19	0.23	0.15	0.19	0.14	0.17
63	0.64	0.80	0.40	0.51	0.29	0.36	0.24	0.30	0.21	0.26	0.17	0.21	0.15	0.19
80	0.72	0.90	0.45	0.57	0.32	0.40	0.27	0.33	0.23	0.29	0.19	0.24	0.17	0.21
100	0.80	1.00	0.51	0.64	0.36	0.45	0.30	0.37	0.26	0.32	0.21	0.27	0.19	0.23

	25		32		40		50		63		80		100	
DC	f_{min}	f_{max}	f_{min}	f_{max}	f_{min}	f_{max}	f_{min}	f_{max}	f_{min}	f_{max}	f_{min}	f_{max}	f_{min}	f_{max}
50	0.13	0.16	0.12	0.14	0.11	0.14	0.13	0.16	-	-	-	-	-	-
63	0.14	0.17	0.12	0.16	0.12	0.15	0.11	0.14	0.13	0.16	-	-	-	-
80	0.15	0.19	0.14	0.17	0.13	0.16	0.12	0.15	0.11	0.14	0.13	0.16	-	-
100	0.17	0.21	0.15	0.19	0.14	0.17	0.13	0.16	0.12	0.15	0.11	0.14	0.13	0.16

	ADMX 16-F	ADEX 16-FM	ADMX 16-M								ADMX 16-R	
	0.8	0.8	0.4	0.8	1.6	2.0	3.0	3.2	4.0	5.0	0.8	1.6
	2.99	2.18	3.39	2.99	1.62	1.23	0.28	0.09	2.69	1.52	2.99	1.62

	ADMX 16-MF	ADMX 16-MM		
	0.8	0.4	0.8	1.6
	2.99	3.39	2.99	1.62



ISO				
50J3R100H50-SAD16E54-C	50	3	54	50.5
50J3R140H50-SAD16E80-C	50	3	80	76.5
63J3R140H50-SAD16E68-C	63	3	68	64.5
63J3R155H50-SAD16E95-C	63	3	95	91.5
80J4R165H50-SAD16E108-C	80	4	108	104.5
50J3R140G50-SAD16E80-C	50	3	80	76.5
63J3R155G50-SAD16E95-C	63	3	95	91.5
80J4R165G50-SAD16E108-C	80	4	108	104.5
50J3R140X50-SAD16E68-C	50	3	68	64.5
63J3R155X50-SAD16E80-C	63	3	80	76.5
80J4R165X50-SAD16E95-C	80	4	95	91.5
50T03R-S90AD16E40-C	50	3	40	36.5
63T04R-S90AD16E40-C	63	4	40	36.5
63T04R-S90AD16E68-C	63	4	68	64.5
80T04R-S90AD16E55-C	80	4	55	51.5
80T04R-S90AD16E80-C	80	4	80	76.5
100T05R-S90AD16E80-C	100	5	80	76.5

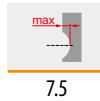

ADMX/ADEX 16	R
ADMX 160630SR-M	2.5
ADMX 160632SR-M	2.5
ADMX 160640SR-M	4.0
ADMX 160650SR-M	4.5



J(T)-SLSN

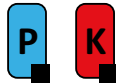

PRAMET

S



ROUGH SN Long Edge Mill for Heavy Milling with Internal Coolant

90° long edge end mill utilising LNET 16 and SN.. 13 inserts with APMX of 104 up to 134 mm. Body has exchangeable end piece. Suitable for shoulder, slot, face and plunge milling. Available in DIN 69871, BT and DIN 2080 50 taper style, in Ø63 and Ø80 mm. Body treated for longer tool life.

ROUGH SN

KAPR	90°
APMX	104.0 - 134.0 mm

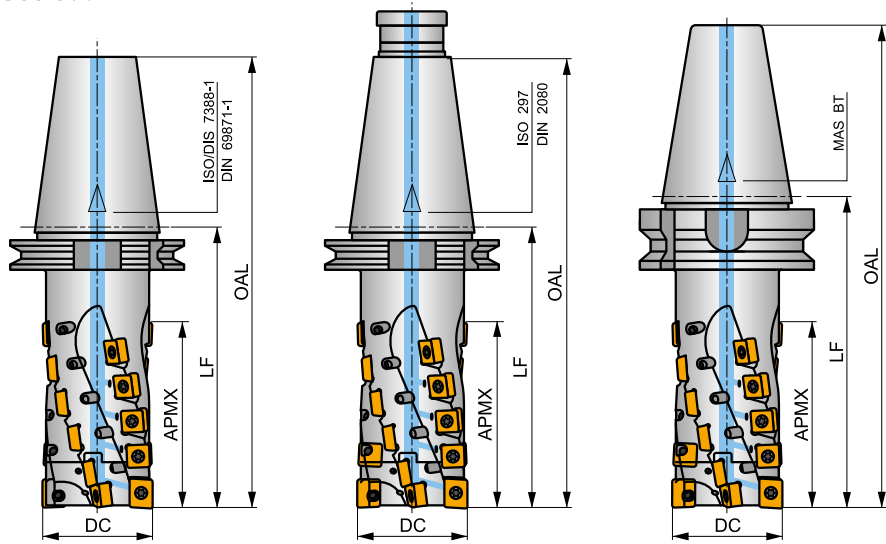
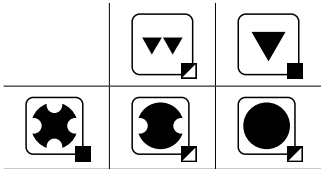
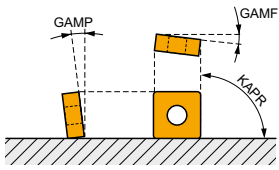

h_m 0.08 - 0.22



Product	DC	OAL	APMX	LF	GAMF	GAMP	CZCMS	NOF	LN	SN	max.	kg	GI209	SQ934		
	(mm)	(mm)	(mm)	(mm)	(°)	(°)										
63J2R155H50-SLSN104-C	63	257	104.00	155	-9	-10	50	4	2	20	-	8500	✓	5.03	GI209	SQ934
80J2R190H50-SLSN134-C	80	292	134.00	190	-9	-10	50	4	2	26	-	7500	✓	7.45	GI209	SQ935
63J2R155G50-SLSN104-C	63	282	104.00	155	-9	-10	50	4	2	20	-	8500	✓	5.20	GI209	SQ934
80J2R190G50-SLSN134-C	80	317	134.00	190	-9	-10	50	4	2	26	-	7500	✓	7.40	GI209	SQ935
63J2R175X50-SLSN104-C	63	277	104.00	175	-9	-10	50	4	2	20	-	8500	✓	6.10	GI209	SQ934
80J2R210X50-SLSN134-C	80	312	134.00	210	-9	-10	50	4	2	26	-	7500	✓	8.50	GI209	SQ935

GI209	LNET 1606..	SN.. 1305..

SQ934	EH6326-SL-C	HS 1230	HXK 10	US 45012-T20P	5.0	M 5	12	SDRT20P-T
SQ935	EH8036-SL-C	HS 1640	HXK 14	US 45012-T20P	5.0	M 5	12	SDRT20P-T



LNET 16

PRAMET

	W1	D1	L	S
	(mm)	(mm)	(mm)	(mm)
1606	13.200	5.90	16.40	6.38

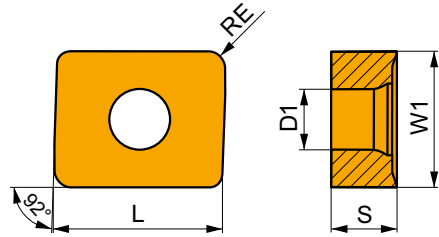

Suitability and starting values for cutting speed (vc), feed (f) and depth of cut (ap). Refer to our Machining Calculator app for further calculations.

Product	RE	P			M			K			N			S			H		
		vc	f	ap	vc	f	ap	vc	f	ap	vc	f	ap	vc	f	ap	vc	f	ap
	(mm)	(m/min)	(mm/tooth)	(mm)	(m/min)	(mm/tooth)	(mm)	(m/min)	(mm/tooth)	(mm)	(m/min)	(mm/tooth)	(mm)	(m/min)	(mm/tooth)	(mm)	(m/min)	(mm/tooth)	(mm)

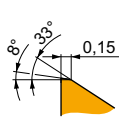
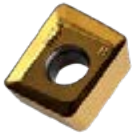

M geometry with highly positive design for medium machining.

LNET 160616SR-M	M8340	1.6	■	105	0.15	15.0	—	—	—	▣	95	0.15	15.0	—	—	—	—	—	—	—	—	—
------------------------	--------------	-----	---	-----	------	------	---	---	---	---	----	------	------	---	---	---	---	---	---	---	---	---

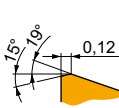
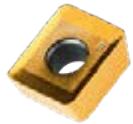

R geometry with highly positive design for medium machining.

LNET 160616SR-R	M8330	1.6	■	100	0.15	15.0	—	—	—	■	95	0.15	15.0	—	—	—	—	—	—	—	—	—
	M8340	1.6	■	95	0.15	15.0	—	—	—	▣	90	0.15	15.0	—	—	—	—	—	—	—	—	—

SNGX 13

PRAMET

	IC	D1	S
	(mm)	(mm)	(mm)
1305	13.200	5.90	5.96

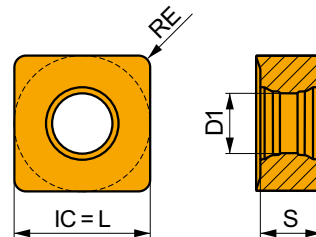

Suitability and starting values for cutting speed (vc), feed (f) and depth of cut (ap). Refer to our Machining Calculator app for further calculations.

Product	RE	P			M			K			N			S			H		
		vc	f	ap	vc	f	ap	vc	f	ap	vc	f	ap	vc	f	ap	vc	f	ap
	(mm)	(m/min)	(mm/tooth)	(mm)	(m/min)	(mm/tooth)	(mm)	(m/min)	(mm/tooth)	(mm)	(m/min)	(mm/tooth)	(mm)	(m/min)	(mm/tooth)	(mm)	(m/min)	(mm/tooth)	(mm)

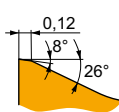

M geometry with positive design for light machining.

SNGX 130512SN-M	M8330	1.2	■	105	0.15	12.0	—	—	—	▣	95	0.15	12.0	—	—	—	—	—	—	—	—	—
	M8340	1.2	■	105	0.15	12.0	—	—	—	▣	95	0.15	12.0	—	—	—	—	—	—	—	—	—



Suitability and starting values for cutting speed (vc), feed (f) and depth of cut (ap). Refer to our Machining Calculator app for further calculations.

Product	RE (mm)	P			M			K			N			S			H		
		vc (m/min)	f (mm/tooth)	ap (mm)	vc (m/min)	f (mm/tooth)	ap (mm)	vc (m/min)	f (mm/tooth)	ap (mm)	vc (m/min)	f (mm/tooth)	ap (mm)	vc (m/min)	f (mm/tooth)	ap (mm)	vc (m/min)	f (mm/tooth)	ap (mm)

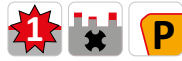
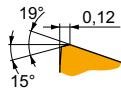

R geometry with positive design for rough machining and unstable conditions.

SNGX 130512PN-R	M8330	1.2	95	0.15	12.0	—	—	—	90	0.15	12.0	—	—	—	—	—	—	—	—
	M8340	1.2	95	0.15	12.0	—	—	—	90	0.15	12.0	—	—	—	—	—	—	—	—

SNET 13



	IC (mm)	D1 (mm)	L (mm)	S (mm)
1305	13.200	5.90	13.20	6.33

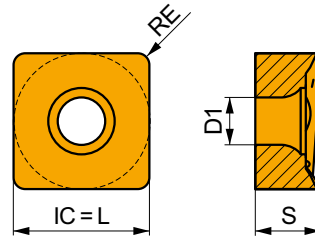

Egnethet og startverdier for skjærehastighet (vc), mating (f) og skjæredybde (ap). Se vår Machining Calculator-app for ytterligere beregninger.

Product	RE (mm)	P			M			K			N			S			H		
		vc (m/min)	f (mm/tooth)	ap (mm)	vc (m/min)	f (mm/tooth)	ap (mm)	vc (m/min)	f (mm/tooth)	ap (mm)	vc (m/min)	f (mm/tooth)	ap (mm)	vc (m/min)	f (mm/tooth)	ap (mm)	vc (m/min)	f (mm/tooth)	ap (mm)

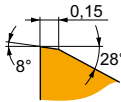

M geometri med positiv design for lett til middels maskinering.

SNET 130512SR-M	M8330	1.2	105	0.15	12.0	—	—	—	95	0.15	12.0	—	—	—	—	—	—	—
	M8340	1.2	105	0.15	12.0	—	—	—	95	0.15	12.0	—	—	—	—	—	—	—



a_s DC	5%	10%	15%	20%	25%	30%	40%	50%	60%	70%	75%	80%	90%	100%
	1.48	1.35	1.27	1.22	1.19	1.16	1.11	1.08	1.05	1.03	1.00	1.00	1.00	1.00



	1	2.5	5	7.5	10	15	20
	f_{min} ↔	f_{min} ↔	f_{min} ↔	f_{min} ↔	f_{min} ↔	f_{min} ↔	f_{min} ↔
63	0.64	1.75	0.40	1.11	0.29	0.79	0.24
80	0.72	1.97	0.45	1.25	0.32	0.89	0.27

	25	32	40	50	63	80
	f_{min} ↔	f_{min} ↔	f_{min} ↔	f_{min} ↔	f_{min} ↔	f_{min} ↔
63	0.14	0.38	0.12	0.34	0.12	0.32
80	0.15	0.42	0.14	0.38	0.13	0.35

	LNET 16-M	LNET 16-R	SNGX 13-M	SNGX 13-R	SNET 13-M
RE	1.6	1.6	1.2	1.2	1.2
BS	-	-	-	-	-



ISO				
63J2R155H50-SLSN104-C	63	2+2	104	101.2
80J2R190H50-SLSN134-C	80	2+2	134	131.2
63J2R155G50-SLSN104-C	63	2+2	104	101.2
80J2R190G50-SLSN134-C	80	2+2	134	131.2
63J2R175X50-SLSN104-C	63	2+2	104	101.2
80J2R210X50-SLSN134-C	80	2+2	134	131.2



J(T)-SSAP

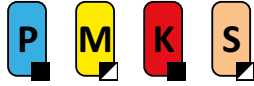

PRAMET

S



Long Edge End Mill for Medium Milling for AP.. 15 and SP.. 12 Inserts

90° long edge end mill utilising AP.. 15 and SP.. 12 inserts with APMX of 58 up to 95 mm. Body has exchangeable end piece. Suitable for shoulder, slot, face and plunge milling. Available in DIN 69871 and DIN 2080 50 taper style, in Ø50 up to Ø80 mm. Body treated for longer tool life.

KAPR	90°
APMX	58.0 - 95.0 mm

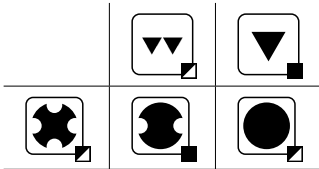
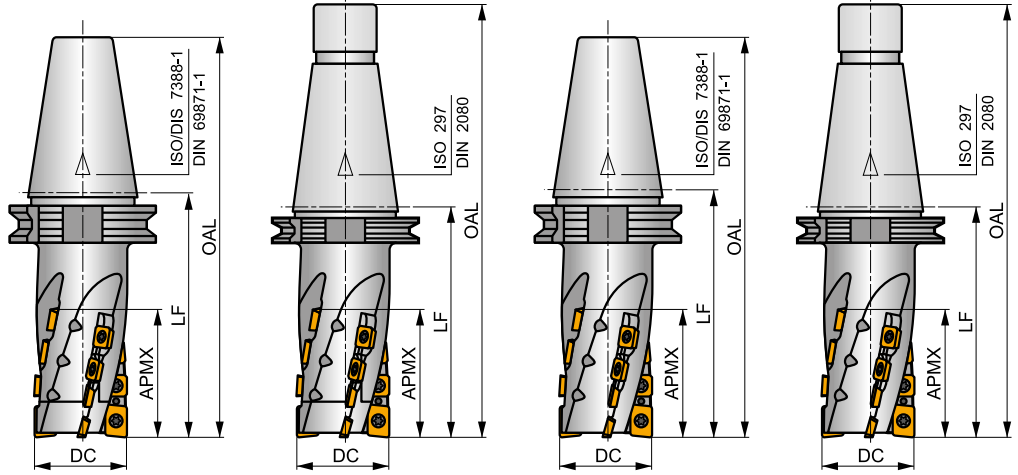
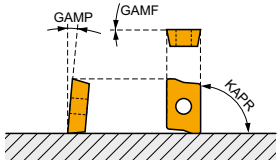

h_m 0.07 - 0.1



Product	DC	OAL	APMX	LF	GAMF	GAMP	CZC MS	NOF	AP	SP	max.	kg	GI128	SQ941	SQ942	SQ943
	(mm)	(mm)	(mm)	(mm)	(°)	(°)										
50J4R110H50-SSAP37+21	50	212	58.00	110	0	7	50	4	2	12	9500	3.65	GI128	SQ942		
50J4R128H50-SSAP55+21	50	230	76.00	128	0	7	50	4	2	16	9500	3.80	GI128	SQ942		
63J4R150H50-SSAP74+21	63	252	95.00	150	0	7	50	4	2	20	8500	4.50	GI128	SQ943		
50J4R124X50-SSAP55+21	50	251	76.00	124	0	7	50	4	2	16	9500	4.43	GI128	SQ942		
63J4R146X50-SSAP74+21	63	273	95.00	146	0	7	50	4	2	20	8500	4.75	GI128	SQ943		
63J4R150H50-SSAP95-A	63	252	95.00	150	0	7	50	4	2	20	8500	4.50	GI128	SQ941		
80J6R155H50-SSAP95-A	80	257	95.00	155	0	7	50	6	3	30	7500	6.30	GI128	SQ941		
50J4R124X50-SSAP76-A	50	251	76.00	124	0	7	50	4	2	16	9500	3.80	GI128	SQ941		
63J4R146X50-SSAP95-A	63	273	95.00	146	0	7	50	4	2	20	8500	4.50	GI128	SQ941		
80J6R151X50-SSAP95-A	80	275	95.00	151	0	7	50	6	3	30	7500	6.20	GI128	SQ941		

GI128	APE. 1504..	SPE. 1204..

SQ941	SQ942	SQ943	US 4511-T20	5.0	M 4.5	11	SDR T20-T
-	P50X21	SR 25	HXX 6	US 4511-T20	5.0	M 4.5	SDR T20-T
-	P63X21	SR 26	HXX 8	US 4511-T20	5.0	M 4.5	SDR T20-T



APET 15

	W1	D1	L	S
	(mm)	(mm)	(mm)	(mm)
1504	12.700	5.50	15.90	4.76

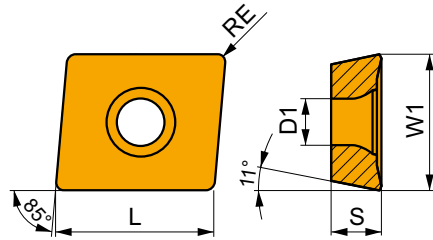

Suitability and starting values for cutting speed (vc), feed (f) and depth of cut (ap). Refer to our Machining Calculator app for further calculations.

Product	RE	P			M			K			N			S			H		
		vc	f	ap	vc	f	ap	vc	f	ap	vc	f	ap	vc	f	ap	vc	f	ap
	(mm)	(m/min)	(mm/tooth)	(mm)	(m/min)	(mm/tooth)	(mm)	(m/min)	(mm/tooth)	(mm)	(m/min)	(mm/tooth)	(mm)	(m/min)	(mm/tooth)	(mm)	(m/min)	(mm/tooth)	(mm)

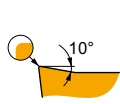
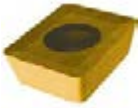

EN edge preparation, positive geometry for light to medium machining.

APET 150412EN	M8330	1.2	■ 225	0.20	12.0	■ 135	0.18	12.0	■ 210	0.20	12.0	■ -	-	-	■ 55	0.14	9.6	■ -	-	-
----------------------	--------------	-----	-------	------	------	-------	------	------	-------	------	------	-----	---	---	------	------	-----	-----	---	---

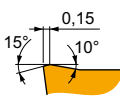
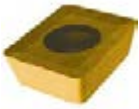

SN edge preparation, positive geometry for medium to heavy machining.

APET 150412SN	M8330	1.2	■ 215	0.25	12.0	■ 125	0.23	12.0	■ 200	0.25	12.0	■ -	-	-	■ 50	0.25	9.6	■ -	-	-
	M8340	1.2	■ 190	0.25	12.0	■ 110	0.23	12.0	■ 180	0.25	12.0	■ -	-	-	■ 45	0.25	9.6	■ -	-	-

APEW 15

	W1	D1	L	M	S
	(mm)	(mm)	(mm)	(mm)	(mm)
1504	12.700	5.50	15.90	4	4.76

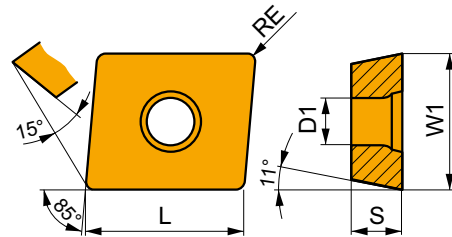

Suitability and starting values for cutting speed (vc), feed (f) and depth of cut (ap). Refer to our Machining Calculator app for further calculations.

Product	RE	P			M			K			N			S			H		
		vc	f	ap	vc	f	ap	vc	f	ap	vc	f	ap	vc	f	ap	vc	f	ap
	(mm)	(m/min)	(mm/tooth)	(mm)	(m/min)	(mm/tooth)	(mm)	(m/min)	(mm/tooth)	(mm)	(m/min)	(mm/tooth)	(mm)	(m/min)	(mm/tooth)	(mm)	(m/min)	(mm/tooth)	(mm)

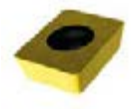

ER edge preparation, zero rake angle geometry for light to medium machining.

APEW 150412ER	M8330	1.2	■ 200	0.20	12.0	■ -	-	-	■ 190	0.20	12.0	■ -	-	-	■ -	-	-	■ 40	0.13	1.0
----------------------	--------------	-----	-------	------	------	-----	---	---	-------	------	------	-----	---	---	-----	---	---	------	------	-----

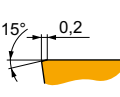
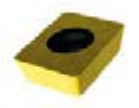

SR edge preparation, zero rake angle geometry for medium to heavy machining.

APEW 150412SR	M8330	1.2	■ 200	0.20	12.0	■ -	-	-	■ 190	0.20	12.0	■ -	-	-	■ -	-	-	■ 40	0.13	1.0
----------------------	--------------	-----	-------	------	------	-----	---	---	-------	------	------	-----	---	---	-----	---	---	------	------	-----



SPET 12



	IC	D1	L	M	S
	(mm)	(mm)	(mm)	(mm)	(mm)
1204	12.700	5.50	12.70	2	4.76

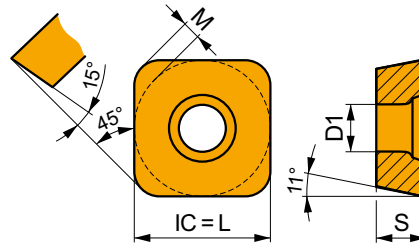

Suitability and starting values for cutting speed (vc), feed (f) and depth of cut (ap). Refer to our Machining Calculator app for further calculations.

Product	RE	P			M			K			N			S			H		
		vc	f	ap	vc	f	ap	vc	f	ap	vc	f	ap	vc	f	ap	vc	f	ap
	(mm)	(m/min)	(mm/tooth)	(mm)	(m/min)	(mm/tooth)	(mm)	(m/min)	(mm/tooth)	(mm)	(m/min)	(mm/tooth)	(mm)	(m/min)	(mm/tooth)	(mm)	(m/min)	(mm/tooth)	(mm)

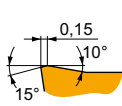
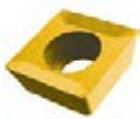

S edge preparation, positive general purpose geometry.

SPET 120408S	M8330	0.8	215	0.20	12.0	125	0.18	12.0	200	0.20	12.0	-	-	-	50	0.18	9.6	-	-	-
	M8340	0.8	190	0.20	12.0	110	0.18	12.0	180	0.20	12.0	-	-	-	45	0.18	9.6	-	-	-

SPET 12 AD



	IC	D1	L	M	S
	(mm)	(mm)	(mm)	(mm)	(mm)
1204	12.700	5.50	12.70	2	4.76

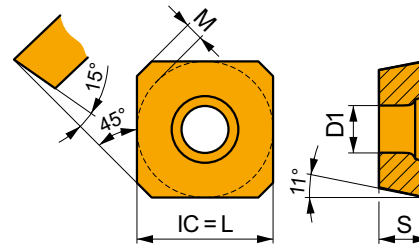

Suitability and starting values for cutting speed (vc), feed (f) and depth of cut (ap). Refer to our Machining Calculator app for further calculations.

Product	RE	P			M			K			N			S			H		
		vc	f	ap	vc	f	ap	vc	f	ap	vc	f	ap	vc	f	ap	vc	f	ap
	(mm)	(m/min)	(mm/tooth)	(mm)	(m/min)	(mm/tooth)	(mm)	(m/min)	(mm/tooth)	(mm)	(m/min)	(mm/tooth)	(mm)	(m/min)	(mm/tooth)	(mm)	(m/min)	(mm/tooth)	(mm)

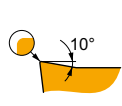
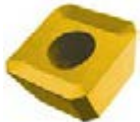

ADEN edge preparation, positive geometry for light to medium machining.

SPET 1204ADEN	M8330	-	245	0.20	12.0	145	0.18	12.0	230	0.20	12.0	-	-	-	60	0.14	9.6	-	-	-
	M8340	-	220	0.20	12.0	130	0.18	12.0	205	0.20	12.0	-	-	-	55	0.14	9.6	-	-	-

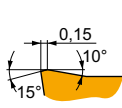
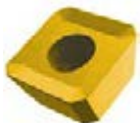

ADSN edge preparation, positive geometry for medium machining.

SPET 1204ADSN	M8330	-	245	0.20	12.0	145	0.18	12.0	230	0.20	12.0	-	-	-	60	0.14	9.6	-	-	-
	M8340	-	220	0.20	12.0	130	0.18	12.0	205	0.20	12.0	-	-	-	55	0.14	9.6	-	-	-



SPEW 12 AD

	IC	D1	L	M	S
	(mm)	(mm)	(mm)	(mm)	(mm)
1204	12.700	5.50	12.70	2	4.76

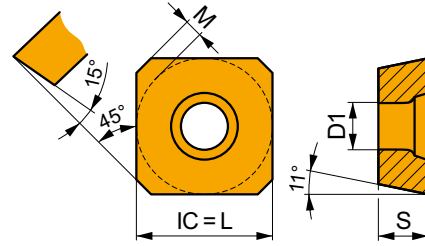

Suitability and starting values for cutting speed (vc), feed (f) and depth of cut (ap). Refer to our Machining Calculator app for further calculations.

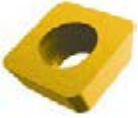
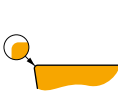
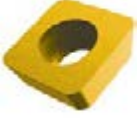
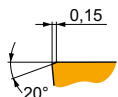
Product	RE (mm)	P			M			K			N			S			H			
		vc (m/min)	f (mm/tooth)	ap (mm)	vc (m/min)	f (mm/tooth)	ap (mm)	vc (m/min)	f (mm/tooth)	ap (mm)	vc (m/min)	f (mm/tooth)	ap (mm)	vc (m/min)	f (mm/tooth)	ap (mm)	vc (m/min)	f (mm/tooth)	ap (mm)	
  <p>ADEN edge preparation, zero rake angle geometry for light to medium machining.</p>																				
SPEW 1204ADEN	M8330	-	220	0.20	12.0	-	-	-	205	0.20	12.0	-	-	-	-	-	-	40	0.10	1.0
  <p>ADSN edge preparation, zero rake angle geometry for medium machining.</p>																				
SPEW 1204ADSN	M8330	-	220	0.20	12.0	-	-	-	205	0.20	12.0	-	-	-	-	-	-	40	0.13	1.0



a_e / DC	5 %	10 %	15 %	20 %	25 %	30 %	40 %	50 %	60 %	70 %	75 %	80 %	90 %	100 %
	0.89	0.81	0.76	0.73	0.71	0.70	0.67	0.65	0.63	0.62	0.60	0.60	0.60	0.45



	1	2.5		5		7.5		10		15		20		
	f_{min} ⇐	f_{max} ⇒	f_{min} ⇐	f_{max} ⇒	f_{min} ⇐	f_{max} ⇒	f_{min} ⇐	f_{max} ⇒	f_{min} ⇐	f_{max} ⇒	f_{min} ⇐	f_{max} ⇒	f_{min} ⇐	f_{max} ⇒
50	0.50	0.71	0.32	0.45	0.23	0.32	0.19	0.27	0.16	0.23	0.14	0.19	0.12	0.17
63	0.56	0.80	0.35	0.51	0.25	0.36	0.21	0.30	0.18	0.26	0.15	0.21	0.13	0.19
80	0.63	0.90	0.40	0.57	0.28	0.40	0.23	0.33	0.20	0.29	0.17	0.24	0.15	0.21

	25	32		40		50		63		80		
	f_{min} ⇐	f_{max} ⇒	f_{min} ⇐	f_{max} ⇒	f_{min} ⇐	f_{max} ⇒	f_{min} ⇐	f_{max} ⇒	f_{min} ⇐	f_{max} ⇒	f_{min} ⇐	f_{max} ⇒
50	0.11	0.16	0.10	0.14	0.10	0.14	0.11	0.16	-	-	-	-
63	0.12	0.17	0.11	0.16	0.10	0.15	0.10	0.14	0.11	0.16	-	-
80	0.13	0.19	0.12	0.17	0.11	0.16	0.10	0.15	0.10	0.14	0.11	0.16

	APET 15	APEW 15	SPET 12	SPET 12AD	SPEW 12AD
	1.2	1.2	0.8	-	-
	-	-	-	-	-













ISO			
50J4R110H50-SSAP37+21	50	2+2	58
50J4R128H50-SSAP55+21	50	2+2	76
63J4R150H50-SSAP74+21	63	2+2	95
50J4R106X50-SSAP37+21	50	2+2	58
50J4R124X50-SSAP55+21	50	2+2	76
63J4R146X50-SSAP74+21	63	2+2	95
50J4R110H50-SSAP58-A	50	2+2	58
50J4R128H50-SSAP76-A	50	2+2	76
63J4R150H50-SSAP95-A	63	2+2	95
80J6R155H50-SSAP95-A	80	3+3	95
50J4R106X50-SSAP58-A	50	2+2	58
50J4R124X50-SSAP76-A	50	2+2	76
63J4R146X50-SSAP95-A	63	2+2	95
80J6R151X50-SSAP95-A	80	3+3	95



INDEXABLE MILLS – NAVIGATOR

SLOT MILLING

	S90SN		S90CN(XN)																
	90°		90°																
	APMX (mm)	4.0 – 14.0	APMX (mm)	14.0 – 30.5															
	DC (mm)	80 – 200	DC (mm)	125 – 315															
Disc		DC = 80 – 200 (mm)		DC = 125 – 315 (mm)															
Shell mill			DC = 63 – 160 (mm)			DC = 125 – 200 (mm)													
Page	366		372																
ISO	P	M	K		P	M	K												
Insert shape																			
Inserts	SNHQ 11 SNHQ 12		CNHQ 1005 XNHQ 1205 XNHQ 1606																
No. of cutting edges	4		2																
Deep slot milling 	■		■																
Deep shoulder milling 	▣		▣																
Face milling 	▣		▣																
Rear face milling 	▣		▣																



S90SN

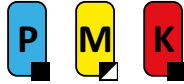

PRAMET

S



Side and Face Disk Milling Cutter

90° side and face cutter utilising SNHQ 11, 12 inserts with APMX (slotting depth) of 10,5 up to 62 mm. Suitable for shoulder, slot, rear side and face milling. Available in arbor or stub arbor style, in range Ø63 up to Ø200 mm. Body treated for longer tool life.

KAPR	90°
CW	4.0 - 14.0 mm

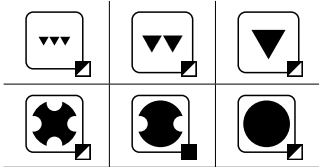
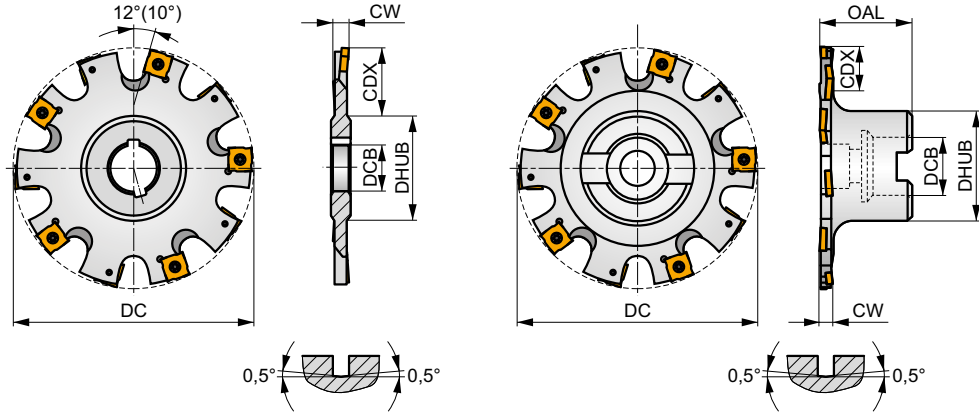
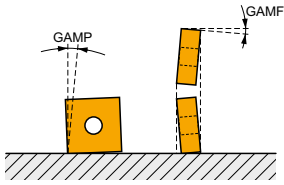

	0.07 - 0.09
	0.07 - 0.09



Product	DC	OAL	DCB	DHUB	CDX	CW		GAMF	GAMP									
	(mm)	(mm)	(mm)	(mm)	(mm)	(mm)												
80F8N-S90SN11N4	80	-	27	42	16	4.00	-	2.5	-0.5	8	-	12300	-	0.23	GI151	DI011	-	
80F8N-S90SN11N5	80	-	27	42	16	5.00	-	2.5	-0.5	8	-	12300	-	0.22	GI152	DI019	-	
80F8N-S90SN12N6	80	-	27	42	16	6.00	-	2.5	-0.5	8	-	8400	-	0.25	GI153	DI012	-	
80F8N-S90SN12N8	80	-	27	42	16	8.00	-	2.5	-0.5	8	-	8400	-	0.28	GI157	DI013	-	
100G10N-S90SN12N6	100	-	32	48	24	6.00	-	2.5	-0.5	10	-	7500	-	0.43	GI153	DI012	-	
100G10N-S90SN12N8	100	-	32	48	24	8.00	-	2.5	-0.5	10	-	7500	-	0.42	GI157	DI013	-	
100G10N-S90SN12N10	100	-	32	48	24	10.00	-	2.5	-0.5	10	-	7500	-	0.46	GI154	DI014	-	
100G10N-S90SN12N12	100	-	32	48	24	12.00	-	2.5	-0.5	10	-	7500	-	0.66	GI158	DI015	-	
125H12N-S90SN12N6	125	-	40	58	31	6.00	-	2.5	-0.5	12	-	6700	-	0.62	GI153	DI012	-	
125H12N-S90SN12N8	125	-	40	58	31	8.00	-	2.5	-0.5	12	-	6700	-	0.73	GI157	DI013	-	
125H12N-S90SN12N10	125	-	40	58	31	10.00	-	2.5	-0.5	12	-	6700	-	0.66	GI154	DI014	-	
125H12N-S90SN12N12	125	-	40	58	31	12.00	-	2.5	-0.5	12	-	6700	-	0.76	GI158	DI015	-	
160H16N-S90SN12N6	160	-	40	58	43	6.00	-	2.5	-0.5	16	-	5900	-	0.86	GI153	DI012	-	
160H16N-S90SN12N8	160	-	40	58	43	8.00	-	2.5	-0.5	16	-	5900	-	1.10	GI157	DI013	-	
160H16N-S90SN12N10	160	-	40	58	43	10.00	-	2.5	-0.5	16	-	5900	-	1.14	GI154	DI014	-	
160H16N-S90SN12N12	160	-	40	58	43	12.00	-	2.5	-0.5	16	-	5900	-	1.30	GI158	DI015	-	
160H15N-S90SN12N14	160	-	40	58	43	14.00	-	2.5	-0.5	15	-	5900	-	1.40	GI158	DI015	-	
200J18N-S90SN12N6	200	-	50	72	62	6.00	-	2.5	-0.5	18	-	5300	-	1.40	GI153	DI012	-	
200J18N-S90SN12N8	200	-	50	72	62	8.00	-	2.5	-0.5	18	-	5300	-	1.78	GI157	DI013	-	
200J18N-S90SN12N10	200	-	50	72	62	10.00	-	2.5	-0.5	18	-	5300	-	1.89	GI154	DI014	-	
200J18N-S90SN12N12	200	-	50	72	62	12.00	-	2.5	-0.5	18	-	5300	-	2.23	GI158	DI015	-	
200J18N-S90SN12N14	200	-	50	72	62	14.00	-	2.5	-0.5	18	-	5300	-	2.67	GI158	DI015	-	
63A03R-S90SN11N4	63	40	16	34	10.5	4.00	3	2.5	-0.5	6	-	13900	-	0.39	GI151	DI021	-	
63A03R-S90SN11N5	63	40	16	34	10.5	5.00	3	2.5	-0.5	6	-	13900	-	0.36	GI152	DI021	-	
63A03R-S90SN12N6	63	40	16	34	10.5	6.00	3	2.5	-0.5	6	-	9500	-	0.37	GI153	DI022	-	
80A04R-S90SN11N5	80	40	22	40	17.5	5.00	4	2.5	-0.5	8	-	12300	-	0.48	GI152	DI023	-	
80A04R-S90SN12N6	80	40	22	40	17.5	6.00	4	2.5	-0.5	8	-	8400	-	0.50	GI153	DI024	-	



Product	DC	OAL	DCB	DHUB	CDX	CW		GAMF	GAMP								
	(mm)	(mm)	(mm)	(mm)	(mm)	(mm)		(°)	(°)								
100A05R-S90SN12N6	100	50	27	48	23.5	6.00	5	2.5	-0.5	10	-	7500	-	0.86	GI153	DI025	-
125B06R-S90SN12N6	125	50	40	56	24	6.00	6	2.5	-0.5	12	-	6700	-	1.20	GI153	DI012	AC003
160B08R-S90SN12N10	160	50	40	70	41	10.00	8	2.5	-0.5	16	-	5900	-	2.03	GI154	DI014	-

GI151	SNHQ 1102..
GI152	SNHQ 1103..
GI153	SNHQ 1203..
GI154	SNHQ 1205..
GI157	SNHQ 1204..
GI158	SNHQ 1207

DI011	US 3504-T09P	3.0	M 3.5	4	D-T07P/T09P	FG-15	-
DI012	US 70	5.0	M 4	5	D-T07/T15	FG-15	-
DI013	US 71	5.0	M 4	7	D-T07/T15	FG-15	-
DI014	US 72	5.0	M 4	9	D-T07/T15	FG-15	-
DI015	US 73	5.0	M 4	11	D-T07/T15	FG-15	-
DI019	US 3505-T09P	3.0	M 3.5	5	D-T07P/T09P	FG-15	HS 0830
DI021	US 3504-T09P	3.0	M 3.5	4	D-T07P/T09P	FG-15	HS 0830
DI022	US 70	5.0	M 4	5	D-T07/T15	FG-15	HS 0830
DI023	US 3505-T09P	3.0	M 3.5	5	D-T07P/T09P	FG-15	HS 1030
DI024	US 70	5.0	M 4	5	D-T07/T15	FG-15	HS 1030
DI025	US 70	5.0	M 4	5	D-T07/T15	FG-15	HS 1230

AC003	KS 2040	K.FMH40



SNHQ AZ



	IC (mm)	D1 (mm)	W1 (mm)
1102	11.000	4.30	2.300
1103	11.000	4.30	2.700
1203	12.700	5.00	3.200
1204	12.700	5.00	4.500
1205	12.700	5.00	5.400
1207	12.700	5.00	7.000

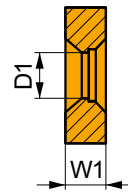
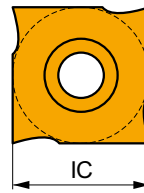

Suitability and starting values for cutting speed (vc), feed (f) and depth of cut (ap). Refer to our Machining Calculator app for further calculations.

Product	RE (mm)	P			M			K			N			S			H		
		vc (m/min)	f (mm/tooth)	ap (mm)	vc (m/min)	f (mm/tooth)	ap (mm)	vc (m/min)	f (mm/tooth)	ap (mm)	vc (m/min)	f (mm/tooth)	ap (mm)	vc (m/min)	f (mm/tooth)	ap (mm)	vc (m/min)	f (mm/tooth)	ap (mm)

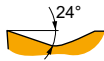

EN geometry with special design for slot milling.

SNHQ 1203AZEN	8215	–	■ 415	0.10	–	▣ 245	0.10	–	■ 390	0.10	–	–	–	–	–	–	–	–	–
	M8340	–	■ 370	0.10	–	▣ 220	0.10	–	■ 350	0.10	–	–	–	–	–	–	–	–	–
SNHQ 1204AZEN	8215	–	■ 405	0.10	–	▣ 240	0.10	–	■ 380	0.10	–	–	–	–	–	–	–	–	–
	M8340	–	■ 355	0.10	–	▣ 210	0.10	–	■ 335	0.10	–	–	–	–	–	–	–	–	–
SNHQ 1205AZEN	8215	–	■ 390	0.10	–	▣ 230	0.10	–	■ 370	0.10	–	–	–	–	–	–	–	–	–
	M8340	–	■ 345	0.10	–	▣ 205	0.10	–	■ 325	0.10	–	–	–	–	–	–	–	–	–
SNHQ 1207AZEN	8215	–	■ 380	0.10	–	▣ 225	0.10	–	■ 360	0.10	–	–	–	–	–	–	–	–	–
	M8340	–	■ 335	0.10	–	▣ 200	0.10	–	■ 315	0.10	–	–	–	–	–	–	–	–	–

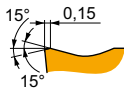

TN geometry with special design for slot milling.

SNHQ 1102AZTN	M8330	–	■ 365	0.20	–	▣ 215	0.18	–	■ 345	0.20	–	–	–	–	–	–	–	–	–
	M8340	–	■ 335	0.20	–	▣ 200	0.18	–	■ 315	0.20	–	–	–	–	–	–	–	–	–
SNHQ 1103AZTN	M8330	–	■ 345	0.20	–	▣ 205	0.18	–	■ 325	0.20	–	–	–	–	–	–	–	–	–
	M8340	–	■ 315	0.20	–	▣ 185	0.18	–	■ 295	0.20	–	–	–	–	–	–	–	–	–

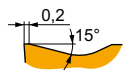

TN geometry with special design for slot milling.

SNHQ 1203AZTN	M8330	–	■ 345	0.20	–	▣ 205	0.18	–	■ 325	0.20	–	–	–	–	–	–	–	–	–
	M8340	–	■ 315	0.20	–	▣ 185	0.18	–	■ 295	0.20	–	–	–	–	–	–	–	–	–
SNHQ 1204AZTN	M8330	–	■ 335	0.20	–	▣ 200	0.20	–	■ 315	0.20	–	–	–	–	–	–	–	–	–
	M8340	–	■ 300	0.20	–	▣ 180	0.20	–	■ 285	0.20	–	–	–	–	–	–	–	–	–
SNHQ 1205AZTN	M8330	–	■ 330	0.20	–	▣ 195	0.20	–	■ 310	0.20	–	–	–	–	–	–	–	–	–
	M8340	–	■ 295	0.20	–	▣ 175	0.20	–	■ 280	0.20	–	–	–	–	–	–	–	–	–
SNHQ 1207AZTN	M8330	–	■ 320	0.20	–	▣ 190	0.20	–	■ 300	0.20	–	–	–	–	–	–	–	–	–
	M8340	–	■ 290	0.20	–	▣ 170	0.20	–	■ 275	0.20	–	–	–	–	–	–	–	–	–



SNHQ TRL

	IC (mm)	D1 (mm)	L (mm)	W1 (mm)
1203	12.700	5.00	12.70	3.200
1204	12.700	5.00	12.70	4.500
1205	12.700	5.00	12.70	5.400
1207	12.700	5.00	12.70	7.000

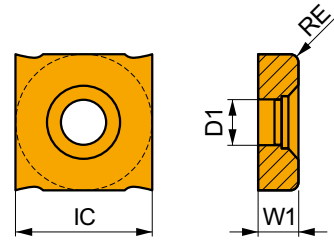

Suitability and starting values for cutting speed (vc), feed (f) and depth of cut (ap). Refer to our Machining Calculator app for further calculations.

Product	RE (mm)	P			M			K			N			S			H		
		vc (m/min)	f (mm/tooth)	ap (mm)	vc (m/min)	f (mm/tooth)	ap (mm)	vc (m/min)	f (mm/tooth)	ap (mm)	vc (m/min)	f (mm/tooth)	ap (mm)	vc (m/min)	f (mm/tooth)	ap (mm)	vc (m/min)	f (mm/tooth)	ap (mm)

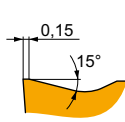

TRL geometry with special design for slot milling.

SNHQ 120305TRL	M8340	0.5	230	0.20	–	135	0.18	–	215	0.20	–	–	–	–	–	–	–	–	–
SNHQ 120310TRL	M8340	1.0	285	0.20	–	170	0.18	–	270	0.20	–	–	–	–	–	–	–	–	–
SNHQ 120315TRL	M8340	1.5	300	0.20	–	180	0.18	–	285	0.20	–	–	–	–	–	–	–	–	–
SNHQ 120405TRL	M8340	0.5	220	0.20	–	130	0.20	–	205	0.20	–	–	–	–	–	–	–	–	–
SNHQ 120415TRL	M8340	1.5	290	0.20	–	170	0.20	–	275	0.20	–	–	–	–	–	–	–	–	–
SNHQ 120505TRL	M8340	0.5	215	0.20	–	125	0.20	–	200	0.20	–	–	–	–	–	–	–	–	–
SNHQ 120515TRL	M8340	1.5	280	0.20	–	165	0.20	–	265	0.20	–	–	–	–	–	–	–	–	–
SNHQ 120705TRL	M8340	0.5	210	0.20	–	125	0.20	–	195	0.20	–	–	–	–	–	–	–	–	–
SNHQ 120710TRL	M8340	1.0	265	0.20	–	155	0.20	–	250	0.20	–	–	–	–	–	–	–	–	–



a_e DC	0.05	0.10	0.15	0.20	0.25	0.30	0.40	0.50	0.60	0.70	0.75	0.80	0.90	1.00
	1.48	1.35	1.27	1.22	1.19	1.16	1.11	1.08	1.05	1.03	1.00	1.00	1.00	1.00

	SNHQ AZEN	SNHQ AZTN	SNHQ 12TRL
	-	-	0.5-1.5
	-	-	-

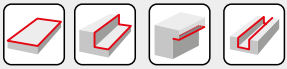
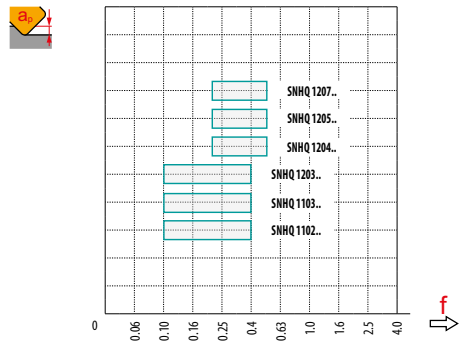

	80	4	16	16
	100	5	24	24
	125	6	31	31
	160	5	43	43
	200	9	62	62
	63	3	10.5	63
	80	4	17.5	80
	100	5	23.5	100
	125	6	24	125
	160	8	41	160



	a_e	5		10		15		20		25	
		f_{min}	f_{max}	f_{min}	f_{max}	f_{min}	f_{max}	f_{min}	f_{max}	f_{min}	f_{max}
	80	0.28	0.36	0.20	0.26	0.17	0.21	-	-	-	-
	100	0.32	0.41	0.23	0.29	0.19	0.24	0.16	0.21	-	-
	125	0.35	0.45	0.25	0.32	0.21	0.27	0.18	0.23	0.16	0.21
	160	0.40	0.51	0.28	0.36	0.23	0.30	0.20	0.26	0.18	0.23
	200	0.44	0.57	0.32	0.41	0.26	0.33	0.23	0.29	0.20	0.26
	63	0.25	0.32	0.18	0.23	0.15	0.19	0.13	0.17	0.12	0.15
	80	0.28	0.36	0.20	0.26	0.17	0.21	0.15	0.19	0.13	0.17
	100	0.32	0.41	0.23	0.29	0.19	0.24	0.16	0.21	0.15	0.19
	125	0.35	0.45	0.25	0.32	0.21	0.27	0.18	0.23	0.16	0.21
	160	0.40	0.51	0.28	0.36	0.23	0.30	0.20	0.26	0.18	0.23



	a _e	32		40		50		63		80	
		f _{min} ⇨	f _{max} ⇨	f _{min} ⇨	f _{max} ⇨	f _{min} ⇨	f _{max} ⇨	f _{min} ⇨	f _{max} ⇨	f _{min} ⇨	f _{max} ⇨
	80	-	-	-	-	-	-	-	-	-	-
	100	-	-	-	-	-	-	-	-	-	-
	125	-	-	-	-	-	-	-	-	-	-
	160	0.16	0.21	0.15	0.19	-	-	-	-	-	-
	200	0.18	0.23	0.16	0.21	0.15	0.19	-	-	-	-
	63	0.11	0.14	0.10	0.13	0.10	0.12	0.10	0.11	-	-
	80	0.12	0.15	0.11	0.14	0.10	0.13	0.10	0.12	0.10	0.11
	100	0.13	0.17	0.12	0.15	0.11	0.14	0.10	0.13	0.10	0.12
	125	0.15	0.19	0.13	0.17	0.12	0.15	0.11	0.14	0.10	0.13
	160	0.16	0.21	0.15	0.19	0.13	0.17	0.12	0.16	0.11	0.14

	a _e	100		125		160	
		f _{min} ⇨	f _{max} ⇨	f _{min} ⇨	f _{max} ⇨	f _{min} ⇨	f _{max} ⇨
	80	-	-	-	-	-	-
	100	-	-	-	-	-	-
	125	-	-	-	-	-	-
	160	-	-	-	-	-	-
	200	-	-	-	-	-	-
	63	-	-	-	-	-	-
	80	-	-	-	-	-	-
	100	0.10	0.11	-	-	-	-
	125	0.10	0.12	0.10	0.11	-	-
	160	0.10	0.13	0.10	0.12	0.10	0.11



S90CN(XN)

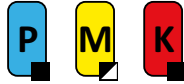

PRAMET

S

Side and Face Disk Milling Cutter with Adjustable Width

90° side and face cutter utilising CNHQ 10 and XNHQ 12, 16 inserts with APMX (slotting depth) of 25 up to 110 mm. Suitable for shoulder, slot, rear side and face milling. Available in arbor or stub arbor style, in range Ø125 up to Ø315 mm. Body treated for longer tool life.



KAPR	90°
CW	14.0 - 30.5 mm

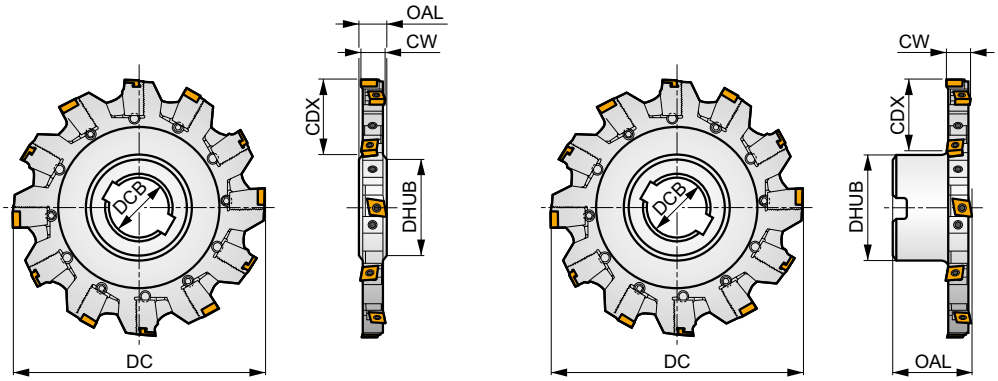
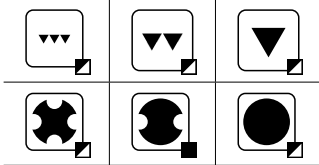
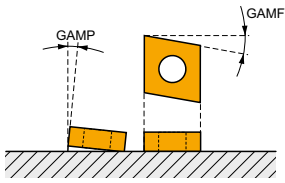

	0.07 - 0.09
	0.07 - 0.09



Product	DC	OAL	DCB	DHUB	CDX	CW	GAMF	GAMP									
	(mm)	(mm)	(mm)	(mm)	(mm)	(mm)	(°)	(°)									
125H04N-S90CN10N18	125	18	40	56	34	14.0 ÷ 18.5	-10	4	4	8	-	7800	-	1.50	GI195	DI051	-
160H06N-S90CN10N18	160	18	40	56	50	14.0 ÷ 18.5	-8	4	6	12	-	6900	-	1.80	GI195	DI052	-
160H05N-S90XN12N24	160	24	40	56	50	19.0 ÷ 24.3	-8	5	5	10	-	5200	-	2.50	GI196	DI056	-
200J07N-S90CN10N18	200	18	50	71	60	14.0 ÷ 18.5	-8	4	7	14	-	6100	-	2.85	GI195	DI053	-
200J06N-S90XN12N24	200	24	50	71	60	19.0 ÷ 24.3	-8	5	6	12	-	4700	-	3.60	GI196	DI057	-
200J06N-S90XN16N30	200	30	50	71	60	24.5 ÷ 30.5	-9	5	6	12	-	4000	-	6.00	GI197	DI060	-
250J09N-S90CN10N18	250	18	50	71	85	14.0 ÷ 18.5	-8	4	9	18	-	5500	-	5.30	GI195	DI054	-
250J08N-S90XN12N24	250	24	50	71	85	19.0 ÷ 24.3	-8	5	8	16	-	4200	-	7.50	GI196	DI058	-
250J08N-S90XN16N30	250	30	50	71	85	24.5 ÷ 30.5	-8	5	8	16	-	3600	-	8.00	GI197	DI061	-
315J12N-S90CN10N18	315	18	50	71	110	14.0 ÷ 18.5	-8	4	12	24	-	4900	-	7.80	GI195	DI055	-
315J10N-S90XN12N24	315	24	50	71	110	19.0 ÷ 24.3	-8	5	10	20	-	3700	-	11.00	GI196	DI059	-
315K10N-S90XN16N30	315	30	60	85	110	24.5 ÷ 30.5	-8	5	10	20	-	3200	-	13.00	GI197	DI062	-
125B04R-S90CN10N18	125	50	40	70	25	14.0 ÷ 18.5	-10	4	4	8	-	7800	-	1.65	GI195	DI071	AC003
160B06R-S90CN10N18	160	50	40	70	44	14.0 ÷ 18.5	-8	5	6	12	-	6900	-	2.55	GI195	DI072	-
160B05R-S90XN12N24	160	50	40	70	44	19.0 ÷ 24.3	-8	5	5	10	-	5200	-	2.90	GI196	DI074	-
200C06R-S90XN12N24	200	50	40	90	52	19.0 ÷ 24.3	-8	5	6	12	-	6100	-	4.70	GI196	DI075	-
200C07R-S90CN10N18	200	50	40	90	52	14.0 ÷ 18.5	-8	4	7	14	-	6100	-	4.05	GI195	DI073	-



GI195	CNHQ 1005..
GI196	XNHQ 1205..
GI197	XNHQ 1606..



DI051	125H04N-S-14-08	KL-1418-CN10	KR-1418-CN10	KS 613F	DS 6018F	SDR T20	SS 6005-T09P	SDR T09	US 4011-T15P	3.5	M 4	10.6	SDRT15P	-
DI052	160H06N-S-14-12	KL-1418-CN10	KR-1418-CN10	KS 613F	DS 6018F	SDR T20	SS 6005-T09P	SDR T09	US 4011-T15P	3.5	M 4	10.6	SDRT15P	-
DI053	200J07N-S-14-14	KL-1418-CN10	KR-1418-CN10	KS 613F	DS 6018F	SDR T20	SS 6005-T09P	SDR T09	US 4011-T15P	3.5	M 4	10.6	SDRT15P	-
DI054	250J09N-S-14-18	KL-1418-CN10	KR-1418-CN10	KS 613F	DS 6018F	SDR T20	SS 6005-T09P	SDR T09	US 4011-T15P	3.5	M 4	10.6	SDRT15P	-
DI055	315J12N-S-14-24	KL-1418-CN10	KR-1418-CN10	KS 613F	DS 6018F	SDR T20	SS 6005-T09P	SDR T09	US 4011-T15P	3.5	M 4	10.6	SDRT15P	-
DI056	160H05N-S-19-10	KL-1924-XN12	KR-1924-XN12	KS 617M	DS 6500	-	SS 6005-T09P	SDR T09	US 4011-T15P	3.5	M 4	10.6	SDRT15P	HXX 4
DI057	200J06N-S-19-12	KL-1924-XN12	KR-1924-XN12	KS 617M	DS 6500	-	SS 6005-T09P	SDR T09	US 4011-T15P	3.5	M 4	10.6	SDRT15P	HXX 4
DI058	250J08N-S-19-16	KL-1924-XN12	KR-1924-XN12	KS 617M	DS 6500	-	SS 6005-T09P	SDR T09	US 4011-T15P	3.5	M 4	10.6	SDRT15P	HXX 4
DI059	315J10N-S-19-20	KL-1924-XN12	KR-1924-XN12	KS 617M	DS 6500	-	SS 6005-T09P	SDR T09	US 4011-T15P	3.5	M 4	10.6	SDRT15P	HXX 4
DI060	200J06N-S-25-12	KL-2530-XN16	KR-2530-XN16	KS 623M	DS 6500	-	SS 6005-T09P	SDR T09	US 4011-T15P	3.5	M 4	10.6	SDRT15P	HXX 4
DI061	250J08N-S-25-16	KL-2530-XN16	KR-2530-XN16	KS 623M	DS 6500	-	SS 6005-T09P	SDR T09	US 4011-T15P	3.5	M 4	10.6	SDRT15P	HXX 4
DI062	315K10N-S-25-20	KL-2530-XN16	KR-2530-XN16	KS 623M	DS 6500	-	SS 6005-T09P	SDR T09	US 4011-T15P	3.5	M 4	10.6	SDRT15P	HXX 4
DI071	125B04R-S-14-08	KL-1418-CN10	KR-1418-CN10	KS 613F	DS 6018F	SDR T20	SS 6005-T09P	SDR T09	US 4011-T15P	3.5	M 4	10.6	SDRT15P	-
DI072	160B06R-S-14-12	KL-1418-CN10	KR-1418-CN10	KS 613F	DS 6018F	SDR T20	SS 6005-T09P	SDR T09	US 4011-T15P	3.5	M 4	10.6	SDRT15P	-
DI073	200C07R-S-14-14	KL-1418-CN10	KR-1418-CN10	KS 613F	DS 6018F	SDR T20	SS 6005-T09P	SDR T09	US 4011-T15P	3.5	M 4	10.6	SDRT15P	-
DI074	160B05R-S-19-10	KL-1924-XN12	KR-1924-XN12	KS 617M	DS 6500	-	SS 6005-T09P	SDR T09	US 4011-T15P	3.5	M 4	10.6	SDRT15P	HXX 4
DI075	200C06R-S-19-12	KL-1924-XN12	KR-1924-XN12	KS 617M	DS 6500	-	SS 6005-T09P	SDR T09	US 4011-T15P	3.5	M 4	10.6	SDRT15P	HXX 4



AC003	KS 2040	K.FMH40
-------	---------	---------



CNHQ



	BCH	IC	D1	L	W1
	(mm)	(mm)	(mm)	(mm)	(mm)
1005	0.50	10.000	4.70	10.00	5.400

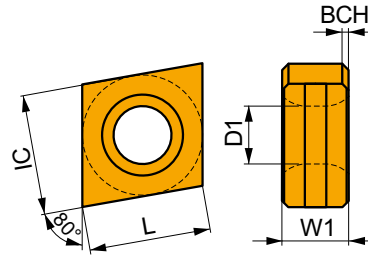

Suitability and starting values for cutting speed (vc), feed (f) and depth of cut (ap). Refer to our Machining Calculator app for further calculations.

Product	RE	P			M			K			N			S			H		
		vc	f	ap	vc	f	ap	vc	f	ap	vc	f	ap	vc	f	ap	vc	f	ap
	(mm)	(m/min)	(mm/tooth)	(mm)	(m/min)	(mm/tooth)	(mm)	(m/min)	(mm/tooth)	(mm)	(m/min)	(mm/tooth)	(mm)	(m/min)	(mm/tooth)	(mm)	(m/min)	(mm/tooth)	(mm)

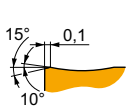
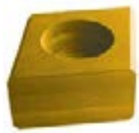

Special design for slot milling with light to heavy cutting conditions.

CNHQ 1005AZTN	M8330	-	■	310	0.15	-	■	185	0.14	-	■	290	0.15	-	-	-	-	-	-	-	-
	M8340	-	■	280	0.15	-	■	165	0.14	-	■	265	0.15	-	-	-	-	-	-	-	-

XNHQ



	BCH	IC	D1	L	W1
	(mm)	(mm)	(mm)	(mm)	(mm)
1205	0.50	10.000	4.70	12.70	5.400
1606	0.50	12.000	5.90	16.00	6.400

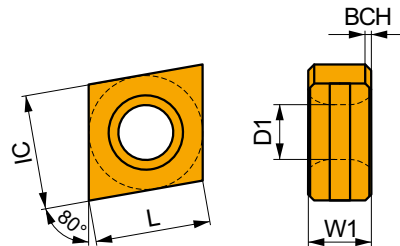

Suitability and starting values for cutting speed (vc), feed (f) and depth of cut (ap). Refer to our Machining Calculator app for further calculations.

Product	RE	P			M			K			N			S			H		
		vc	f	ap	vc	f	ap	vc	f	ap	vc	f	ap	vc	f	ap	vc	f	ap
	(mm)	(m/min)	(mm/tooth)	(mm)	(m/min)	(mm/tooth)	(mm)	(m/min)	(mm/tooth)	(mm)	(m/min)	(mm/tooth)	(mm)	(m/min)	(mm/tooth)	(mm)	(m/min)	(mm/tooth)	(mm)

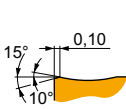

Special design for slot milling.

XNHQ 1205AZTN	M8330	-	■	310	0.15	-	■	185	0.14	-	■	290	0.15	-	-	-	-	-	-	-
	M8340	-	■	275	0.15	-	■	165	0.14	-	■	260	0.15	-	-	-	-	-	-	-
XNHQ 1606AZTN	M8330	-	■	300	0.15	-	■	180	0.14	-	■	285	0.15	-	-	-	-	-	-	-
	M8340	-	■	270	0.15	-	■	160	0.14	-	■	255	0.15	-	-	-	-	-	-	-



a_e DC	0.05	0.10	0.15	0.20	0.25	0.30	0.40	0.50	0.60	0.70	0.75	0.80	0.90	1.00
X.V	1.48	1.35	1.27	1.22	1.19	1.16	1.11	1.08	1.05	1.03	1.00	1.00	1.00	1.00

	CNHQ 10	XNHQ 12	XNHQ 16
RE	-	-	-
BS	-	-	-

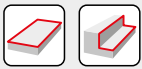
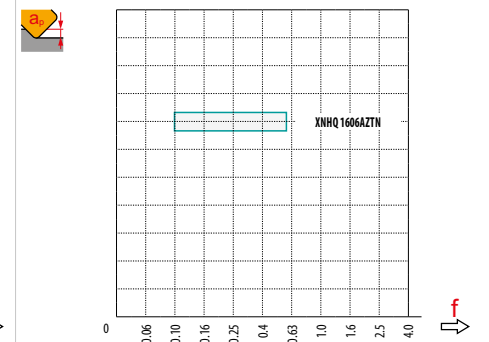
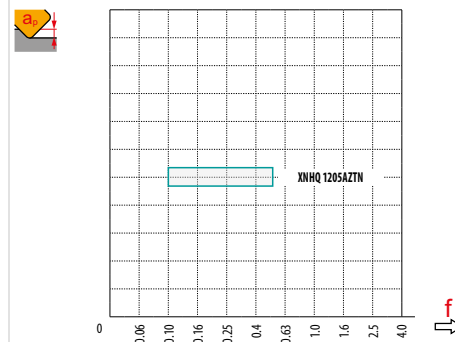
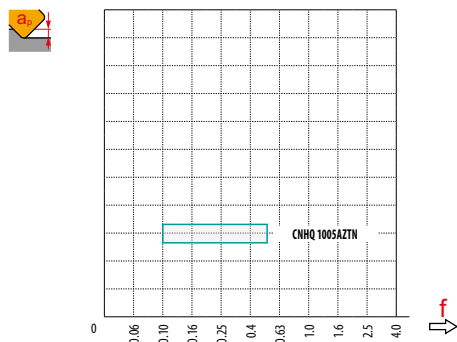























	125	4	34	34
	160	6	50	50
	200	7	60	60
	250	9	85	85
	315	12	110	110
	125	4	25	125
	160	6	44	160
	200	7	52	200



	a_e	5		10		15		20		25	
		f_{min}	f_{max}	f_{min}	f_{max}	f_{min}	f_{max}	f_{min}	f_{max}	f_{min}	f_{max}
	125	0.35	0.45	0.25	0.32	0.21	0.27	0.18	0.23	0.16	0.21
	160	0.40	0.51	0.28	0.36	0.23	0.30	0.20	0.26	0.18	0.23
	200	0.44	0.57	0.32	0.41	0.26	0.33	0.23	0.29	0.20	0.26
	250	0.50	0.64	0.35	0.45	0.29	0.37	0.25	0.32	0.23	0.29
	315	0.56	0.72	0.39	0.51	0.32	0.42	0.28	0.36	0.25	0.32
	125	0.35	0.45	0.25	0.32	0.21	0.27	0.18	0.23	0.16	0.21
	160	0.40	0.51	0.28	0.36	0.23	0.30	0.20	0.26	0.18	0.23
	200	0.44	0.57	0.32	0.41	0.26	0.33	0.23	0.29	0.20	0.26



	a_e	32		40		50		63		80	
		f_{min} 	f_{max} 	f_{min} 	f_{max} 	f_{min} 	f_{max} 	f_{min} 	f_{max} 	f_{min} 	f_{max} 
	125	0.15	0.19	–	–	–	–	–	–	–	–
	160	0.16	0.21	0.15	0.19	–	–	–	–	–	–
	200	0.18	0.23	0.16	0.21	0.15	0.19	–	–	–	–
	250	0.20	0.26	0.18	0.23	0.16	0.21	0.15	0.19	0.13	0.17
	315	0.22	0.29	0.20	0.26	0.18	0.23	0.16	0.21	0.15	0.19
	125	0.15	0.19	0.13	0.17	0.12	0.15	0.11	0.14	0.10	0.13
	160	0.16	0.21	0.15	0.19	0.13	0.17	0.12	0.16	0.11	0.14
	200	0.18	0.23	0.16	0.21	0.15	0.19	0.13	0.17	0.12	0.15

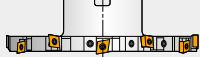

















	a_e	100		125		160		200	
		f_{min} 	f_{max} 	f_{min} 	f_{max} 	f_{min} 	f_{max} 	f_{min} 	f_{max} 
	125	–	–	–	–	–	–	–	–
	160	–	–	–	–	–	–	–	–
	200	–	–	–	–	–	–	–	–
	250	–	–	–	–	–	–	–	–
	315	0.13	0.17	–	–	–	–	–	–
	125	0.10	0.12	0.10	0.11	–	–	–	–
	160	0.10	0.13	0.10	0.12	0.10	0.11	–	–
	200	0.11	0.14	0.10	0.13	0.10	0.12	0.10	0.11



INDEXABLE MILLS – NAVIGATOR

COPY MILLING



	SRC16		SRC20		SRD12		SRD16																					
	-		-		-		-																					
	APMX (mm)	8.0	APMX (mm)	10.0	APMX (mm)	3.0	APMX (mm)	4.0																				
	DCX (mm)	63 – 160	DCX (mm)	80 – 160	DCX (mm)	24 – 80	DCX (mm)	32 – 100																				
Cylindrical shank																												
Weldon																												
Modular						DCX = 24 – 42 (mm)		DCX = 32 (mm)																				
Shell mill						DCX = 50 – 80 (mm)		DCX = 52 – 100 (mm)																				
Page	378		382		386		391																					
ISO	P	M	K	S	H	P	M	K	S	H	P	M	K	N	S	H	P	M	K	N	S	H						
Insert shape																												
Inserts	RC 1606		RC 2006		RD 12T3		RD 1604																					
No. of cutting edges	-		-		-		-																					
Shape surfaces milling (copy milling) 	■		■		■		■																					
Face milling 	■		■		■		■																					
Helical interpolation 	■		■		■		■																					
Progressive plunging 	■		■		■		■																					
Ramping 	■		■		■		■																					
Shallow slot milling 																												
Deep shoulder milling 																												
Chamfer milling 																												
Plunge milling 																												



SRC16

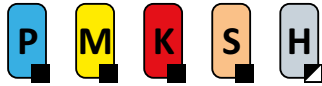

PRAMET

S



Copy Milling Cutter for Round Inserts RCMT 16 with Internal Coolant

Milling cutter for medium to heavy copy milling utilising positive RCMT 16 inserts with APMX of 8 mm. Internal coolant. Suitable for face, helical interpolation, ramping, progressive plunge and high-feed milling. Available in arbor style in range Ø63 up to Ø160 mm. Body treated for longer tool life.

APMX	8.0 mm
------	--------

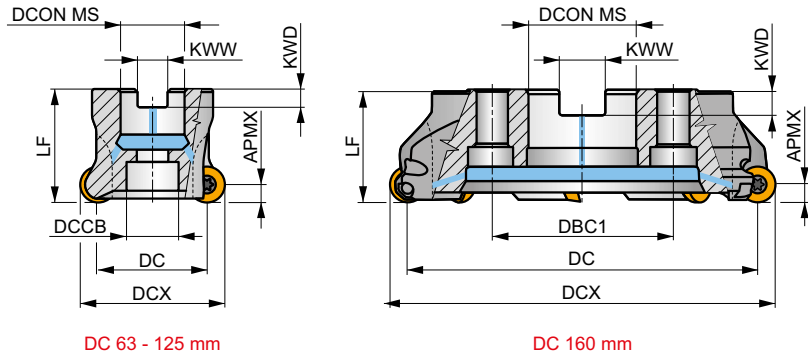
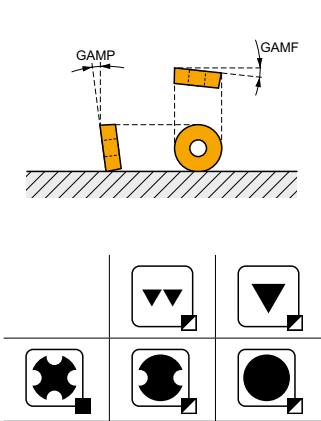

h_m 0.1 - 0.25



Product	DCX (mm)	DC (mm)	DCON MS (mm)	DCCB (mm)	DBC1 (mm)	LF (mm)	KWW (mm)	KWD (mm)	GAMF (°)	GAMP (°)	max.	kg	ISO 6462 EN 9330	GI280	C0033	C0030	C0030	AC002
63A04R-SMORC16-C	63	47	22	18	-	50	10.4	6.3	-2.6	-7	4	9700	✓	0.61	GI280	C0033	-	-
66A05R-SMORC16-C	66	50	27	22	-	50	12.4	7	-2.5	-7	5	9200	✓	0.60	GI280	C0030	-	-
80A05R-SMORC16-C	80	64	27	37	-	50	12.4	7	-1.7	-7	5	8600	✓	0.88	GI280	C0030	-	-
100A06R-SMORC16-C	100	84	32	45	-	50	14.4	8	-1.7	-7	6	7700	✓	1.33	GI280	C0031	AC002	-
125A07R-SMORC16-C	125	109	40	36	-	63	16.4	9	-1.2	-7	7	6500	✓	3.07	GI280	C0032	-	-
160C08R-SMORC16-C	160	144	40	-	66.7	63	16.4	9	-0.9	-7	8	5400	✓	5.68	GI280	C0034	-	-

GI280	RCMT 1606M0..
-------	---------------

	US 65014-T20P	Nm	M 5	14	SDRT20P-T	HS 1230C	-	-	-
C0030	US 65014-T20P	5.0	M 5	14	SDRT20P-T	HS 1230C	-	-	-
C0031	US 65014-T20P	5.0	M 5	14	SDRT20P-T	-	-	-	-
C0032	US 65014-T20P	5.0	M 5	14	SDRT20P-T	HSD 2040	-	-	-
C0033	US 65014-T20P	5.0	M 5	14	SDRT20P-T	HS 1030C	-	-	-
C0034	US 65014-T20P	5.0	M 5	14	SDRT20P-T	HS 1240C	CAC 160C	HSD 0825C	HXK 5

AC002	KS 1635	K.FMH32
-------	---------	---------



RCMT 16

	INSD	D1	S
	(mm)	(mm)	(mm)
1606	16.000	5.50	6.35

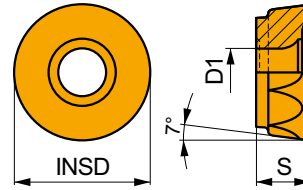

Suitability and starting values for cutting speed (vc), feed (f) and depth of cut (ap). Refer to our Machining Calculator app for further calculations.

Product	RE	P			M			K			N			S			H		
		vc	f	ap	vc	f	ap	vc	f	ap	vc	f	ap	vc	f	ap	vc	f	ap
	(mm)	(m/min)	(mm/tooth)	(mm)	(m/min)	(mm/tooth)	(mm)	(m/min)	(mm/tooth)	(mm)	(m/min)	(mm/tooth)	(mm)	(m/min)	(mm/tooth)	(mm)	(m/min)	(mm/tooth)	(mm)

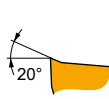

F geometry with highly positive design for light machining.

RCMT 1606MOEN-F	M8310	-	410	0.10	2.0	205	0.09	2.0	-	-	-	-	-	-	-	-	-	-	-
	M8330	-	370	0.10	2.0	220	0.09	2.0	-	-	-	-	-	90	0.07	1.6	-	-	-

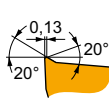

M geometry with highly positive design for medium machining.

RCMT 1606MOSN-M	M6330	-	255	0.20	2.0	180	0.18	2.0	-	-	-	-	-	75	0.16	1.6	-	-	-	
	M8330	-	300	0.20	2.0	180	0.18	2.0	285	0.20	2.0	-	-	75	0.16	1.6	-	-	-	
	M8345	-	215	0.20	2.0	125	0.18	2.0	-	-	-	-	-	50	0.16	1.6	-	-	-	
	M9325	-	370	0.20	2.0	-	-	-	350	0.20	2.0	-	-	-	-	-	-	-	-	-
	M9340	-	335	0.20	2.0	200	0.18	2.0	-	-	-	-	-	80	0.16	1.6	-	-	-	

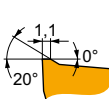

R geometry with positive design for rough copy machining.

RCMT 1606MOSN-R	M8310	-	250	0.40	2.0	-	-	-	235	0.40	2.0	-	-	-	-	-	50	0.20	1.1
	M8330	-	240	0.40	2.0	-	-	-	225	0.40	2.0	-	-	60	0.28	1.6	45	0.20	1.1
	M8345	-	175	0.40	2.0	-	-	-	-	-	-	-	-	40	0.28	1.6	-	-	-

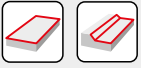

a_e / DCX	5 %	10 %	15 %	20 %	25 %	30 %	40 %	50 %	60 %	70 %	75 %	80 %	90 %	100 %
	1.48	1.35	1.27	1.22	1.19	1.16	1.11	1.08	1.05	1.03	1.00	1.00	1.00	1.00
	2.20	1.60	1.35	1.20	1.10	0.95	0.85	0.75	0.85	0.95	1.00	1.00	1.00	1.00
	0.64	0.64	0.64	0.64	0.64	0.65	0.65	0.67	0.68	0.71	0.72	0.74	0.79	1.00

	RCMT 16-F	RCMT 16-M	RCMT 16-R
	8.0	8.0	8.0
	-	-	-

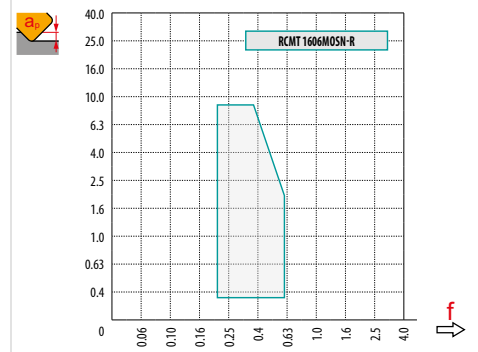
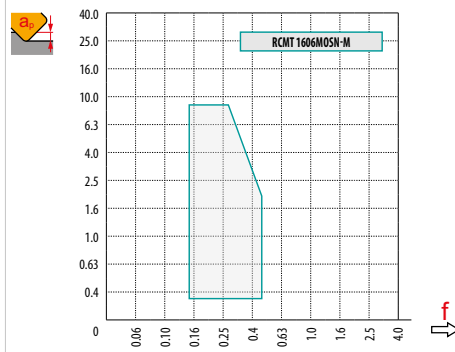
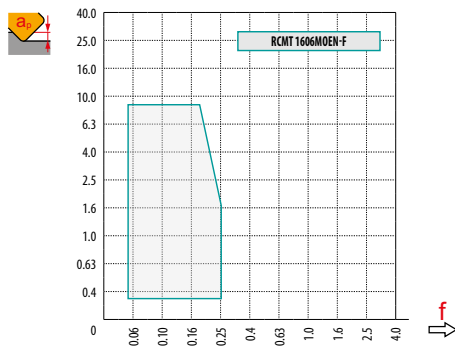







		0.00	0.30	0.50	0.75	1.00	1.25	1.50	2.00	2.50	3.00	4.00	5.00	6.00	7.00	8.00
63		47.0	51.3	52.6	53.8	54.7	55.6	56.3	57.6	58.6	59.5	60.9	61.8	62.5	62.9	63.0
66		50.0	54.3	55.6	56.8	57.8	58.6	59.3	60.6	61.6	62.5	63.9	64.8	65.5	65.9	66.0
80		64.0	68.3	69.6	70.8	71.7	72.6	73.3	74.6	75.6	76.5	77.9	78.8	79.5	79.9	80.0
100		84.0	88.3	89.6	90.8	91.7	92.6	93.3	94.6	95.6	96.5	97.9	98.8	99.5	99.9	100.0
125		109.0	113.3	114.6	115.8	116.7	117.6	118.3	119.6	120.6	121.5	122.9	123.8	124.5	124.9	125.0
160		144.0	148.3	149.6	150.8	151.7	152.6	153.3	154.6	155.6	156.5	157.9	158.8	159.5	159.9	160.0
		-	0.30	0.50	0.75	1.00	1.25	1.50	2.00	2.50	3.00	4.00	5.00	6.00	7.00	8.00
		-	1.10	0.85	0.70	0.61	0.54	0.50	0.43	0.39	0.36	0.31	0.28	0.26	0.25	0.24

	RPMX	APMX/I
63	7.0	8.0/67
66	6.5	8.0/71
80	5.0	8.0/93
100	4.0	6.8/100

	DMIN	DMAX		
63	94.0	126.0	8.0	8.0
66	100.0	132.0	8.0	8.0
80	128.0	160.0	8.0	8.0
100	168.0	200.0	8.0	8.0

5.0



		3	5	10	15	20	30	40	50	60	80	100
63		0.869	1.122	1.587	1.944	2.245	2.750	3.175	3.550	3.888	4.490	5.020
66		0.890	1.149	1.625	1.990	2.298	2.814	3.250	3.633	3.980	4.596	5.138
80		0.980	1.265	1.789	2.191	2.530	3.098	3.578	4.000	4.382	5.060	5.657
100		1.095	1.414	2.000	2.449	2.828	3.464	4.000	4.472	4.899	5.657	6.325
125		1.225	1.581	2.236	2.739	3.162	3.873	4.472	5.000	5.477	6.325	7.071
160		1.386	1.789	2.530	3.098	3.578	4.382	5.060	5.657	6.197	7.155	8.000
		3	5	10	15	20	30	40	50	60	80	100
8.0		0.438	0.566	0.800	0.980	1.131	1.386	1.600	1.789	1.960	2.263	2.530

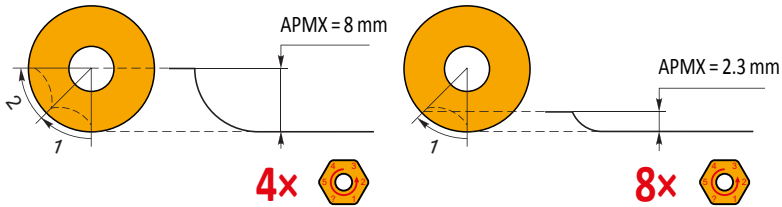



SRC20

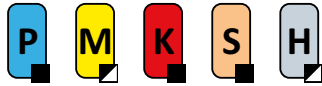

PRAMET

S



Copy Milling Cutter for Round Inserts RCMT 20 with Internal Coolant

Milling cutter for heavy copy milling utilising positive RCMT 16 inserts with APMX of 10 mm. Internal coolant. Suitable for face, helical interpolation, ramping, progressive plunge and high-feed milling. Available in arbor style in range Ø80 up to Ø160 mm. Body treated for longer tool life.

APMX	10.0 mm
------	---------

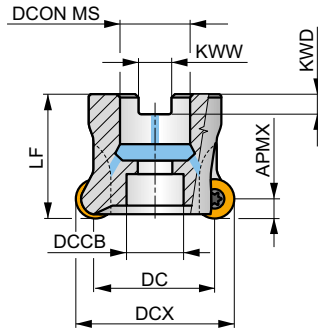
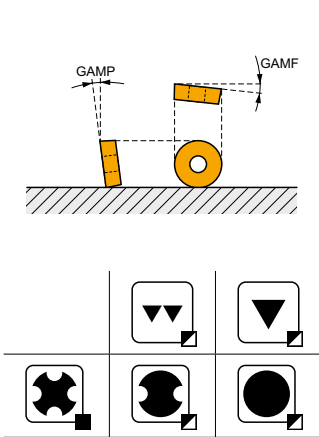

DC 80 - 125 mm

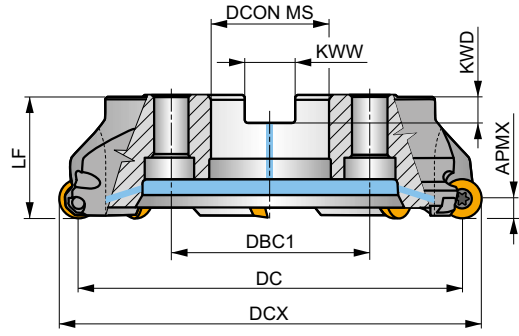

DC 160 mm

0.11 - 0.32



Product	DCX (mm)	DC (mm)	DCON MS (mm)	DCCB (mm)	DBC1 (mm)	LF (mm)	KWW (mm)	KWD (mm)	GAMF (°)	GAMP (°)								
80A04R-SMORC20-C	80	60	27	28	-	50	12.4	7	-2.7	-7	4	-	8500	✓	0.96	GI281	C0040	-
100A05R-SMORC20-C	100	80	32	45	-	50	14.4	8	-1.7	-7	5	-	7600	✓	1.26	GI281	C0041	AC002
125A06R-SMORC20-C	125	105	40	36	-	63	16.4	9	-1	-7	6	-	6500	✓	2.96	GI281	C0042	-
160C07R-SMORC20-C	160	140	40	-	66.7	63	16.4	9	-0.9	-7	7	-	5400	✓	5.44	GI281	C0046	-

GI281	RCMT 2006MO..

C0040	US 66015-T25P	7.5	M 6	15	SDR T25P-T	HS 1230C	-	-	-
C0041	US 66015-T25P	7.5	M 6	15	SDR T25P-T	-	-	-	-
C0042	US 66015-T25P	7.5	M 6	15	SDR T25P-T	HSD 2040	-	-	-
C0046	US 66015-T25P	7.5	M 6	15	SDR T25P-T	HS 1240C	CAC 160C	HSD 0825C	HXX 5

AC002	KS 1635	K.FMH32



RCMT 20

	INSD	D1	S
	(mm)	(mm)	(mm)
2006	20.000	6.50	6.35

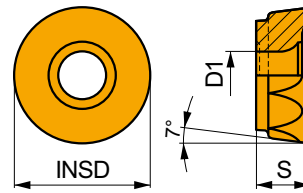

Suitability and starting values for cutting speed (vc), feed (f) and depth of cut (ap). Refer to our Machining Calculator app for further calculations.

Product	RE (mm)	P			M			K			N			S			H		
		vc (m/min)	f (mm/tooth)	ap (mm)	vc (m/min)	f (mm/tooth)	ap (mm)	vc (m/min)	f (mm/tooth)	ap (mm)	vc (m/min)	f (mm/tooth)	ap (mm)	vc (m/min)	f (mm/tooth)	ap (mm)	vc (m/min)	f (mm/tooth)	ap (mm)

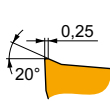

F geometry with highly positive design for light machining.

RCMT 2006MOSN-F	M8330	-	320	0.15	3.0	190	0.14	3.0	-	-	-	-	-	-	80	0.11	2.4	-	-	-
------------------------	--------------	---	-----	------	-----	-----	------	-----	---	---	---	---	---	---	----	------	-----	---	---	---

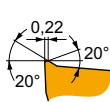

M geometry with highly positive design for medium machining.

RCMT 2006MOSN-M	M6330	-	225	0.30	3.0	155	0.27	3.0	-	-	-	-	-	-	65	0.21	2.4	-	-	-
	M8330	-	255	0.30	3.0	150	0.27	3.0	240	0.30	3.0	-	-	-	60	0.21	2.4	-	-	-
	M8345	-	190	0.30	3.0	110	0.27	3.0	-	-	-	-	-	-	45	0.21	2.4	-	-	-
	M9315	-	330	0.30	3.0	-	-	-	310	0.30	3.0	-	-	-	-	-	-	-	-	-
	M9325	-	315	0.30	3.0	-	-	-	295	0.30	3.0	-	-	-	-	-	-	-	-	-
	M9340	-	275	0.30	3.0	165	0.27	3.0	-	-	-	-	-	-	65	0.21	2.4	-	-	-

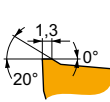

R geometry with positive design for rough copy machining.

RCMT 2006MOSN-R	M8330	-	225	0.45	3.0	-	-	-	210	0.45	3.0	-	-	-	55	0.32	2.4	45	0.23	1.3
	M8345	-	165	0.45	3.0	-	-	-	-	-	-	-	-	40	0.32	2.4	-	-	-	
	M9325	-	260	0.45	3.0	-	-	-	245	0.45	3.0	-	-	-	-	-	-	50	0.23	1.3

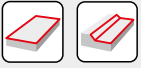

a_e / DCX	5 %	10 %	15 %	20 %	25 %	30 %	40 %	50 %	60 %	70 %	75 %	80 %	90 %	100 %
	1.48	1.35	1.27	1.22	1.19	1.16	1.11	1.08	1.05	1.03	1.00	1.00	1.00	1.00
	2.20	1.60	1.35	1.20	1.10	0.95	0.85	0.75	0.85	0.95	1.00	1.00	1.00	1.00
	0.64	0.64	0.64	0.64	0.64	0.65	0.65	0.67	0.68	0.71	0.72	0.74	0.79	1.00

	RCMT 20-F	RCMT 20-M	RCMT 20-R
	10.0	10.0	10.0
	-	-	-

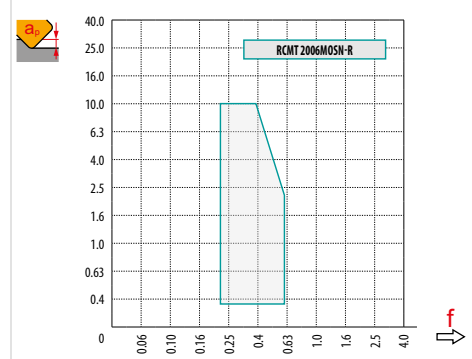
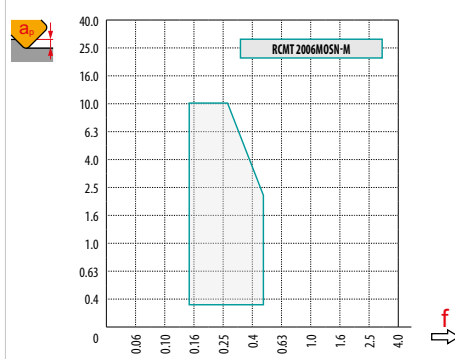
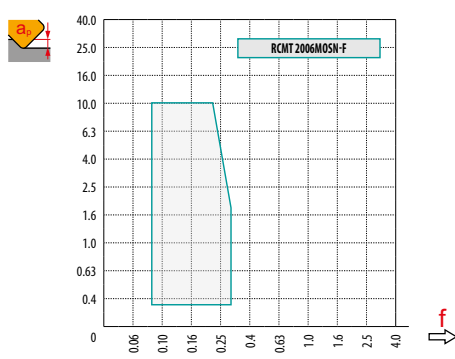





		0.00	0.30	0.50	0.75	1.00	1.25	1.50	2.00	2.50	3.00	4.00	5.00	6.00	7.00	8.00	9.00	10.00
80		60.0	64.9	66.2	67.6	68.7	69.7	70.5	72.0	73.2	74.3	76.0	77.3	78.3	79.1	79.6	79.9	80.0
100		80.0	84.9	86.2	87.6	88.7	89.7	90.5	92.0	93.2	94.3	96.0	97.3	98.3	99.1	99.6	99.9	100.0
125		105.0	109.9	111.2	112.6	113.7	114.7	115.5	117.0	118.2	119.3	121.0	122.3	123.3	124.1	124.6	124.9	125.0
160		140.0	144.9	146.2	147.6	148.7	149.7	150.5	152.0	153.2	154.3	156.0	157.3	158.3	159.1	159.6	159.9	160.0
		-	0.30	0.50	0.75	1.00	1.25	1.50	2.00	2.50	3.00	4.00	5.00	6.00	7.00	8.00	9.00	10.00
		-	1.23	0.95	0.78	0.68	0.61	0.55	0.48	0.43	0.40	0.35	0.31	0.29	0.27	0.26	0.25	0.24

	RPMX	APMX/I
80	7.0	10.0/83
100	5.0	8.6/100

	DMIN	DMAX		
80	120.0	160.0	10.0	10.0
100	160.0	200.0	10.0	10.0

6.0



	μm	3	5	10	15	20	30	40	50	60	80	100
80		0.980	1.265	1.789	2.191	2.530	3.098	3.578	4.000	4.382	5.060	5.657
100		1.095	1.414	2.000	2.449	2.828	3.464	4.000	4.472	4.899	5.657	6.325
125		1.225	1.581	2.236	2.739	3.162	3.873	4.472	5.000	5.477	6.325	7.071
160		1.386	1.789	2.530	3.098	3.578	4.382	5.060	5.657	6.197	7.155	8.000
	μm	3	5	10	15	20	30	40	50	60	80	100
10.0		0.490	0.632	0.894	1.095	1.265	1.549	1.789	2.000	2.191	2.530	2.828

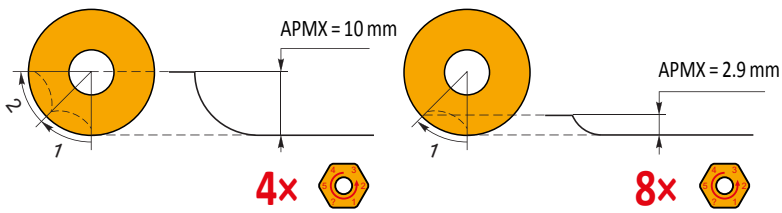



SRD12

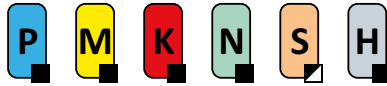

PRAMET

S(C)



Copy Milling Cutter for Round Inserts RD.. 12 with Internal Coolant

Milling cutter for copy milling utilising positive RD.. 12 inserts with APMX of 3 mm. Internal coolant. Suitable for face, helical interpolation, ramping, progressive plunge and copy milling. Available in modular and arbor style, in range Ø24 up to Ø80 mm. Body treated for longer tool life.

APMX	3.0 mm
------	--------

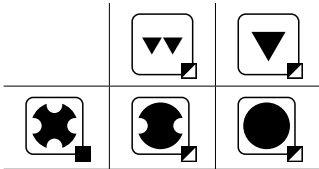
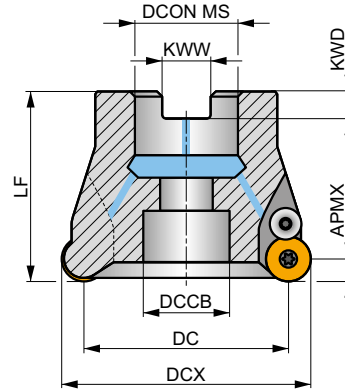
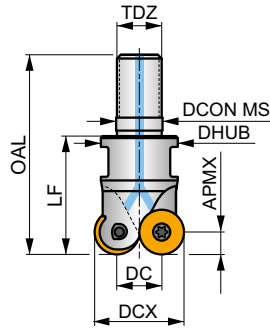
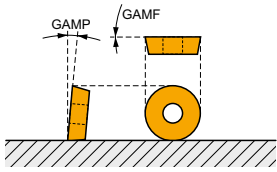

	0.065 - 0.22					
	0.065 - 0.25					

Product	DCX	DC	OAL	DCON MS	DHUB	DCCB	LF	TDZ	KWW	KWD	GAMF	GAMP				kg		
	(mm)	(mm)	(mm)	(mm)	(mm)	(mm)	(mm)	(mm)	(mm)	(°)	(°)	max.						
24E2R032M12-SRD12-CF	24	12	54	12.5	21	-	32	M12	-	-	-3	0	2	-	21900	✓	0.07	GI120 C0362
35E3R042M16-SCRD12-CF	35	23	65	17	29	-	42	M16	-	-	0	0	3	-	18100	✓	0.19	GI120 C0364
35E4R042M16-SRD12-CF	35	23	65	17	29	-	42	M16	-	-	0	0	4	-	18100	✓	0.20	GI120 C0362
42E4R042M16-SCRD12-CF	42	30	65	17	29	-	42	M16	-	-	0	0	4	-	16600	✓	0.21	GI120 C0364
42E5R042M16-SRD12-CF	42	30	65	17	29	-	42	M16	-	-	0	0	5	-	16600	✓	0.22	GI120 C0366
50A05R-SCMORD12-CF	50	38	-	22	-	18	50	-	10.4	10.4	2	7	5	-	15200	✓	0.29	GI120 C0366
52A05R-SCMORD12-CF	52	40	-	22	-	18	50	-	10.4	10.4	2	7	5	-	14900	✓	0.32	GI120 C0366
66A06R-SCMORD12-CF	66	54	-	27	-	22	50	-	12.4	12.4	2	7	6	-	13200	✓	0.54	GI120 C0370
80A07R-SCMORD12-CF	80	68	-	27	-	38	52	-	12.4	12.4	2	7	7	-	12000	✓	0.89	GI120 C0372

GI120	RD.. 12T3MOT	RDHT 12T3M0-FA

C0362	US 3508-T15P	3.5	M 3.5	8	-	-	Flag T15P	-	-
C0364	US 3006-T09P	2.0	M 3	6	D-T07P/T09P	FG-15	HS 1230C	-	-
C0366	US 3508-T15P	3.5	M 3.5	8	D-T08P/T15P	FG-15	-	CS12P	HS 1030C
C0370	US 3508-T15P	3.5	M 3.5	8	D-T08P/T15P	FG-15	-	CS12P	HS 1230C
C0372	US 3508-T15P	3.5	M 3.5	8	D-T08P/T15P	FG-15	-	CS12P	-



RDHX 12

	INSD (mm)	D1 (mm)	S (mm)
12T3	12.000	3.90	3.97

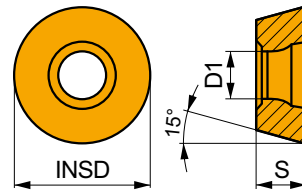

Suitability and starting values for cutting speed (vc), feed (f) and depth of cut (ap). Refer to our Machining Calculator app for further calculations.

Product	RE (mm)	P			M			K			N			S			H		
		vc (m/min)	f (mm/tooth)	ap (mm)	vc (m/min)	f (mm/tooth)	ap (mm)	vc (m/min)	f (mm/tooth)	ap (mm)	vc (m/min)	f (mm/tooth)	ap (mm)	vc (m/min)	f (mm/tooth)	ap (mm)	vc (m/min)	f (mm/tooth)	ap (mm)

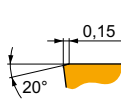

Zero rake angle design for finish machining.

RDHX 12T3MOT	M4303	–	☑	300	0.20	1.5	–	–	–	■	285	0.20	1.5	–	–	–	–	–	–	■	60	0.14	0.8
	M8310	–	☑	300	0.20	1.5	–	–	–	■	285	0.20	1.5	–	–	–	–	–	–	■	60	0.14	0.8
	M8325	–	☑	225	0.20	1.5	–	–	–	–	–	–	–	–	–	–	–	–	–	–	–	–	–
	M8330	–	☑	270	0.20	1.5	–	–	–	■	255	0.20	1.5	–	–	–	–	–	–	☑	50	0.14	0.8
	M8345	–	☑	200	0.20	1.5	–	–	–	–	–	–	–	–	–	–	–	–	–	–	–	–	–

RDMX 12

	INSD (mm)	D1 (mm)	S (mm)
12T3	12.000	3.90	3.97

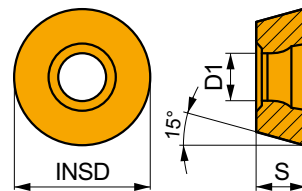

Suitability and starting values for cutting speed (vc), feed (f) and depth of cut (ap). Refer to our Machining Calculator app for further calculations.

Product	RE (mm)	P			M			K			N			S			H		
		vc (m/min)	f (mm/tooth)	ap (mm)	vc (m/min)	f (mm/tooth)	ap (mm)	vc (m/min)	f (mm/tooth)	ap (mm)	vc (m/min)	f (mm/tooth)	ap (mm)	vc (m/min)	f (mm/tooth)	ap (mm)	vc (m/min)	f (mm/tooth)	ap (mm)

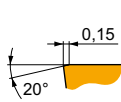

Zero rake angle design for finish machining.

RDMX 12T3MOT	M8310	–	☑	300	0.20	1.5	–	–	–	■	285	0.20	1.5	–	–	–	–	–	–	■	60	0.10	0.8
	M8325	–	☑	225	0.20	1.5	–	–	–	–	–	–	–	–	–	–	–	–	–	–	–	–	
	M8345	–	☑	200	0.20	1.5	–	–	–	–	–	–	–	–	–	–	–	–	–	–	–	–	



RDGT 12



	INSD	D1	S
	(mm)	(mm)	(mm)
12T3	12.000	3.90	3.97

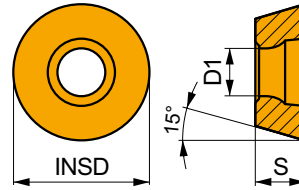

Suitability and starting values for cutting speed (vc), feed (f) and depth of cut (ap). Refer to our Machining Calculator app for further calculations.

Product	RE	P			M			K			N			S			H		
		vc	f	ap	vc	f	ap	vc	f	ap	vc	f	ap	vc	f	ap	vc	f	ap
	(mm)	(m/min)	(mm/tooth)	(mm)	(m/min)	(mm/tooth)	(mm)	(m/min)	(mm/tooth)	(mm)	(m/min)	(mm/tooth)	(mm)	(m/min)	(mm/tooth)	(mm)	(m/min)	(mm/tooth)	(mm)

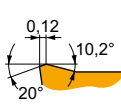

Positive design for finish machining.

RDGT 12T3MOT	M6330	–	■	260	0.20	1.5	■	185	0.18	1.5	–	–	–	–	–	–	■	75	0.14	1.2	–	–	–	
	M8310	–	■	330	0.20	1.5	■	165	0.18	1.5	■	310	0.20	1.5	–	–	–	–	–	–	–	–	–	–
	M8325	–	■	250	0.20	1.5	■	120	0.18	1.5	–	–	–	–	–	–	–	–	–	–	–	–	–	–
	M8345	–	■	225	0.20	1.5	■	135	0.18	1.5	–	–	–	–	–	–	■	55	0.14	1.2	–	–	–	–
	M9340	–	■	340	0.20	1.5	■	200	0.18	1.5	–	–	–	–	–	–	■	85	0.14	1.2	–	–	–	–

RDMT 12



	INSD	D1	S
	(mm)	(mm)	(mm)
12T3	12.000	3.90	3.97

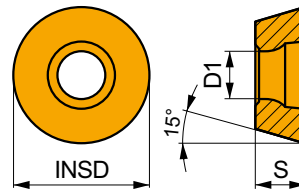

Suitability and starting values for cutting speed (vc), feed (f) and depth of cut (ap). Refer to our Machining Calculator app for further calculations.

Product	RE	P			M			K			N			S			H		
		vc	f	ap	vc	f	ap	vc	f	ap	vc	f	ap	vc	f	ap	vc	f	ap
	(mm)	(m/min)	(mm/tooth)	(mm)	(m/min)	(mm/tooth)	(mm)	(m/min)	(mm/tooth)	(mm)	(m/min)	(mm/tooth)	(mm)	(m/min)	(mm/tooth)	(mm)	(m/min)	(mm/tooth)	(mm)

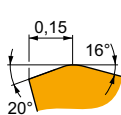

Positive design for finish machining.

RDMT 12T3MOT	M8345	–	■	225	0.20	1.5	■	135	0.18	1.5	–	–	–	–	–	–	–	–	–	–	–	–	–	–
---------------------	--------------	---	---	-----	------	-----	---	-----	------	-----	---	---	---	---	---	---	---	---	---	---	---	---	---	---





a_s DCX	5 %	10 %	15 %	20 %	25 %	30 %	40 %	50 %	60 %	70 %	75 %	80 %	90 %	100 %
	1.48	1.35	1.27	1.22	1.19	1.16	1.11	1.08	1.05	1.03	1.00	1.00	1.00	1.00
	2.20	1.60	1.35	1.20	1.10	0.95	0.85	0.75	0.85	0.95	1.00	1.00	1.00	1.00
	0.64	0.64	0.64	0.64	0.64	0.65	0.65	0.67	0.68	0.71	0.72	0.74	0.79	1.00

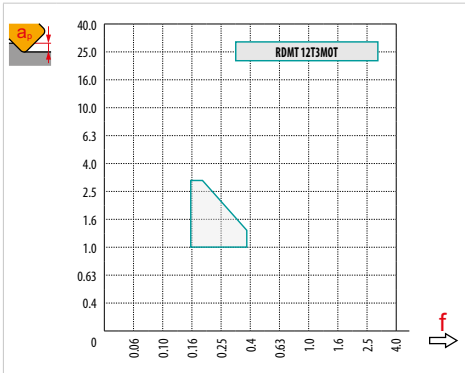
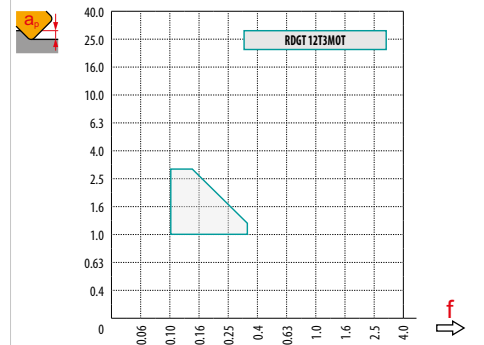
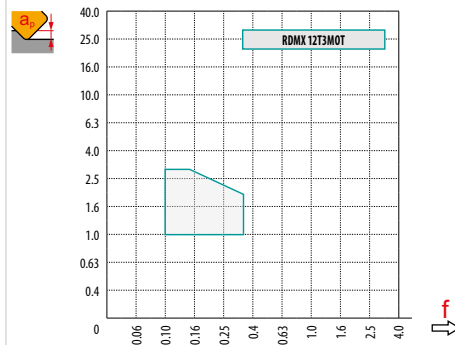
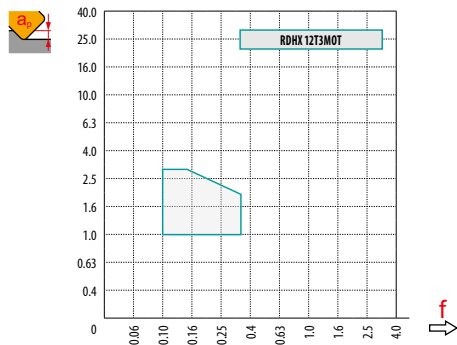

	RDHX 12	RDMX 12	RDGT 12
	6.0	6.0	6.0
	-	-	-









		0.00	0.50	0.75	1.00	1.25	1.50	2.00	2.50	3.00	3.50	4.00	5.00	6.00
24		12.0	16.8	17.8	18.6	19.3	19.9	20.9	21.7	22.4	22.9	23.3	23.8	24.0
35		23.0	27.8	28.8	29.6	30.3	30.9	31.9	32.7	33.4	33.9	34.3	34.8	35.0
42		30.0	34.8	35.8	36.6	37.3	37.9	38.9	39.7	40.4	40.9	41.3	41.8	42.0
50		38.0	42.8	43.8	44.6	45.3	45.9	46.9	47.7	48.4	48.9	49.3	49.8	50.0
52		40.0	44.8	45.8	46.6	47.3	47.9	48.9	49.7	50.4	50.9	51.3	51.8	52.0
66		54.0	58.8	59.8	60.6	61.3	61.9	62.9	63.7	64.4	64.9	65.3	65.8	66.0
80	68.0	72.8	73.8	74.6	75.3	75.9	76.9	77.7	78.4	78.9	79.3	79.8	80.0	
		0.00	0.50	0.75	1.00	1.25	1.50	2.00	2.50	3.00	3.50	4.00	5.00	6.00
		-	0.49	0.40	0.35	0.32	0.29	0.25	0.23	0.21	0.20	0.18	0.17	0.16



		
24	25.0	3.0/14
35	9.0	3.0/39
42	8.0	3.0/44
50	4.0	3.0/87
52	4.0	3.0/87
66	3.0	3.0/100
80	2.2	3.0/100

	DMIN	DMAX		
24	26.0	48.0	3.0	3.0
35	46.0	70.0	3.0	3.0
42	62.0	84.0	3.0	3.0
50	78.0	100.0	2.8	2.8
52	82.0	104.0	2.8	2.8
66	110.0	132.0	2.8	2.8
80	136.0	160.0	2.8	2.8

2.8

		3	5	10	15	20	30	40	50	60	80	100
24		0.537	0.693	0.980	1.200	1.386	1.697	1.960	2.191	2.400	2.771	3.098
35		0.648	0.837	1.183	1.449	1.673	2.049	2.366	2.646	2.898	3.347	3.742
42		0.710	0.917	1.296	1.587	1.833	2.245	2.592	2.898	3.175	3.666	4.099
50		0.775	1.000	1.414	1.732	2.000	2.449	2.828	3.162	3.464	4.000	4.472
52		0.790	1.020	1.442	1.766	2.040	2.498	2.884	3.225	3.533	4.079	4.561
66		0.890	1.149	1.625	1.990	2.298	2.814	3.250	3.633	3.980	4.596	5.138
80		0.980	1.265	1.789	2.191	2.530	3.098	3.578	4.000	4.382	5.060	5.657
		3	5	10	15	20	30	40	50	60	80	100
6.0		0.379	0.490	0.693	0.849	0.980	1.200	1.386	1.549	1.697	1.960	2.191



SRD16

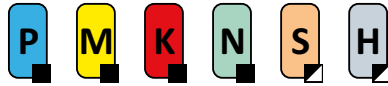

PRAMET

(S(C))



Copy Milling Cutter for Round Inserts RD.. 16 with Internal Coolant

Milling cutter for copy milling utilising positive RD.. 16 inserts with APMX of 4 mm. Internal coolant. Suitable for face, helical interpolation, ramping, progressive plunge and copy milling. Available in modular and arbor style, in range Ø32 up to Ø100 mm. Body treated for longer tool life.

APMX	4.0 mm
------	--------

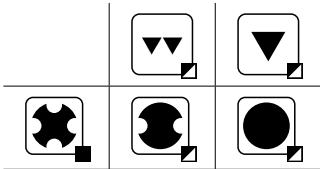
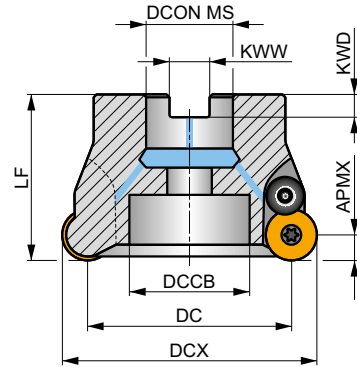
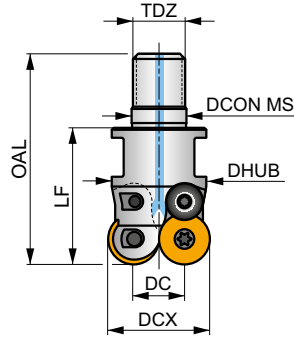
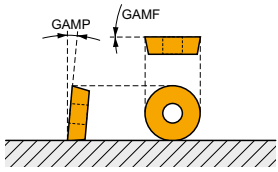

	0.1 - 0.2
	0.11 - 0.25



Product	DCX	DC	OAL	DCON MS	DHUB	DCCB	LF	TDZ	KWW	KWD	GAMF	GAMP	max.		kg	G121	C0374	
	(mm)	(mm)	(mm)	(mm)	(mm)	(mm)	(mm)	(mm)	(mm)	(mm)	(°)	(°)	max.	max.				
32E2R042M16-SCRD16-CF	32	16	65	17	29	-	42	M16	-	-	-2	0	2	-	12600	✓	0.16	G121 C0374
52A04R-SCMORD16-CF	52	36	-	22	-	16.5	50	-	10.4	10.4	0	7	4	-	9900	✓	0.28	G121 C0376
66A05R-SCMORD16-CF	66	50	-	27	-	22	50	-	12.4	12.4	0	7	5	-	8800	✓	0.61	G121 C0378
80A06R-SCMORD16-CF	80	64	-	27	-	38	52	-	12.4	12.4	0	7	6	-	8000	✓	0.75	G121 C0380
100A07R-SCMORD16-CF	100	84	-	32	-	45	52	-	14.4	14.4	0	7	7	-	7100	✓	1.41	G121 C0380

G121	RD.. 1604MOT	RDHT 1604M0-FA

C0374	US 64510-T20P	4.5	M 4.5	10	-	Flag T20P	CS16P	-
C0376	US 64510-T20P	4.5	M 4.5	10	SDR T20P-T	-	CS16P	HS 1030C
C0378	US 64510-T20P	4.5	M 4.5	10	SDR T20P-T	-	CS16P	HS 1230C
C0380	US 64510-T20P	4.5	M 4.5	10	SDR T20P-T	-	CS16P	-



RDHX 16

PRAMET

	INSD	D1	S
	(mm)	(mm)	(mm)
1604	16.000	5.20	4.76

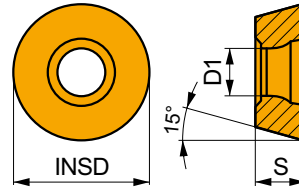

Suitability and starting values for cutting speed (vc), feed (f) and depth of cut (ap). Refer to our Machining Calculator app for further calculations.

Product	RE	P			M			K			N			S			H		
		vc	f	ap	vc	f	ap	vc	f	ap	vc	f	ap	vc	f	ap	vc	f	ap
	(mm)	(m/min)	(mm/tooth)	(mm)	(m/min)	(mm/tooth)	(mm)	(m/min)	(mm/tooth)	(mm)	(m/min)	(mm/tooth)	(mm)	(m/min)	(mm/tooth)	(mm)	(m/min)	(mm/tooth)	(mm)

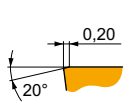

Zero rake angle design for finish machining.

RDHX 1604MOT	M8310	-	255	0.30	2.0	-	-	-	240	0.30	2.0	-	-	-	-	-	-	50	0.15	1.1
	M8325	-	195	0.30	2.0	-	-	-	-	-	-	-	-	-	-	-	-	-	-	-
	M8330	-	245	0.30	2.0	-	-	-	230	0.30	2.0	-	-	-	-	-	-	45	0.15	1.1
	M8345	-	180	0.30	2.0	-	-	-	-	-	-	-	-	-	-	-	-	-	-	-
	M9325	-	290	0.30	2.0	-	-	-	275	0.30	2.0	-	-	-	-	-	-	55	0.15	1.1

RDMX 16

PRAMET

	INSD	D1	S
	(mm)	(mm)	(mm)
1604	16.000	5.20	4.76

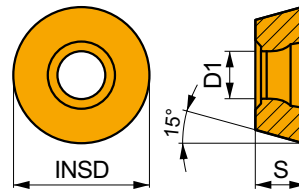

Suitability and starting values for cutting speed (vc), feed (f) and depth of cut (ap). Refer to our Machining Calculator app for further calculations.

Product	RE	P			M			K			N			S			H		
		vc	f	ap	vc	f	ap	vc	f	ap	vc	f	ap	vc	f	ap	vc	f	ap
	(mm)	(m/min)	(mm/tooth)	(mm)	(m/min)	(mm/tooth)	(mm)	(m/min)	(mm/tooth)	(mm)	(m/min)	(mm/tooth)	(mm)	(m/min)	(mm/tooth)	(mm)	(m/min)	(mm/tooth)	(mm)

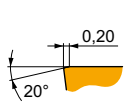

Zero rake angle design for finish machining.

RDMX 1604MOT	M8310	-	255	0.30	2.0	-	-	-	240	0.30	2.0	-	-	-	-	-	-	50	0.15	1.1
--------------	-------	---	-----	------	-----	---	---	---	-----	------	-----	---	---	---	---	---	---	----	------	-----



RDGT 16



	INSD	D1	S
	(mm)	(mm)	(mm)
1604	16.000	5.20	4.76

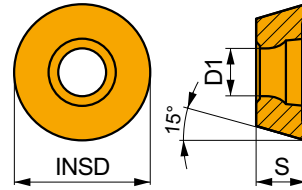

Suitability and starting values for cutting speed (vc), feed (f) and depth of cut (ap). Refer to our Machining Calculator app for further calculations.

Product	RE	P			M			K			N			S			H		
		vc	f	ap	vc	f	ap	vc	f	ap	vc	f	ap	vc	f	ap	vc	f	ap
	(mm)	(m/min)	(mm/tooth)	(mm)	(m/min)	(mm/tooth)	(mm)	(m/min)	(mm/tooth)	(mm)	(m/min)	(mm/tooth)	(mm)	(m/min)	(mm/tooth)	(mm)	(m/min)	(mm/tooth)	(mm)

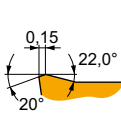

Positive design for finish machining.

RDGT 1604MOT	M8310	-	■	285	0.30	2.0	▣	145	0.27	2.0	■	270	0.30	2.0	-	-	-	-	-	-		
	M8325	-	■	220	0.30	2.0	▣	105	0.27	2.0	-	-	-	-	-	-	-	-	-	-		
	M8345	-	■	200	0.30	2.0	■	120	0.27	2.0	-	-	-	-	-	-	▣	50	0.21	1.6	-	-

RDMT 16



	INSD	D1	S
	(mm)	(mm)	(mm)
1604	16.0	5.20	4.76

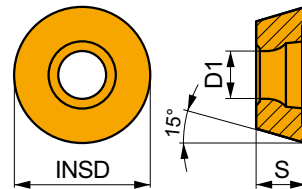

Egnethet og startverdier for skjærehastighet (vc), mating (f) og skjæredybde (ap). Se vår Machining Calculator-app for ytterligere beregninger.

Product	RE	P			M			K			N			S			H		
		vc	f	ap	vc	f	ap	vc	f	ap	vc	f	ap	vc	f	ap	vc	f	ap
	(mm)	(m/min)	(mm/tooth)	(mm)	(m/min)	(mm/tooth)	(mm)	(m/min)	(mm/tooth)	(mm)	(m/min)	(mm/tooth)	(mm)	(m/min)	(mm/tooth)	(mm)	(m/min)	(mm/tooth)	(mm)

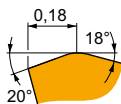

Positiv design for fin maskinering.

RDMT 1604MOT	M8325	-	■	220	0.30	2.0	▣	105	0.27	2.0	-	-	-	-	-	-	-	-	-
	M8345	-	■	200	0.30	2.0	▣	120	0.27	2.0	-	-	-	-	-	-	-	-	-



a_e DCX	5 %	10 %	15 %	20 %	25 %	30 %	40 %	50 %	60 %	70 %	75 %	80 %	90 %	100 %
	1.48	1.35	1.27	1.22	1.19	1.16	1.11	1.08	1.05	1.03	1.00	1.00	1.00	1.00
	2.20	1.60	1.35	1.20	1.10	0.95	0.85	0.75	0.85	0.95	1.00	1.00	1.00	1.00
	0.64	0.64	0.64	0.64	0.64	0.65	0.65	0.67	0.68	0.71	0.72	0.74	0.79	1.00

	RDHX 16	RDMX 16	RDGT 16
	8.0	8.0	8.0
	-	-	-

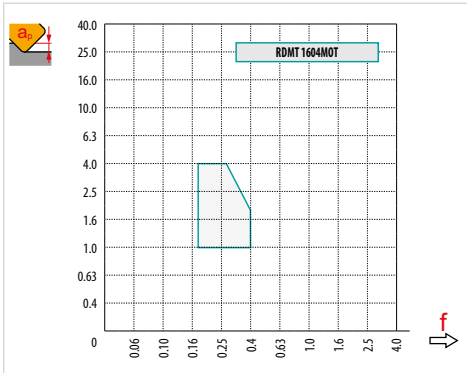
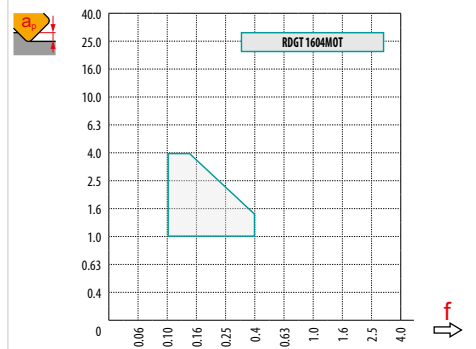
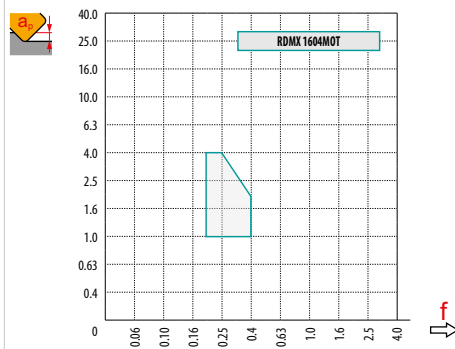
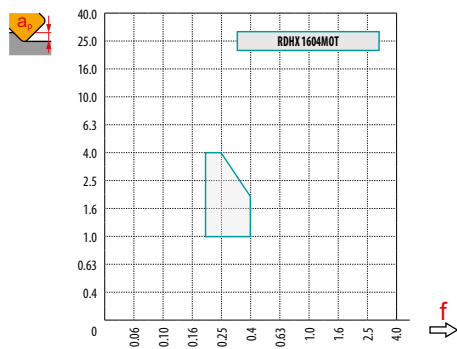

		0.00	0.50	0.75	1.00	1.25	1.50	2.00	2.50	3.00	3.50	4.00	5.00	6.00	7.00	8.00
32		16.0	21.6	22.8	23.7	24.6	25.3	26.6	27.6	28.5	29.2	29.9	30.8	31.5	31.9	32.0
52		36.0	41.6	42.8	43.7	44.6	45.3	46.6	47.6	48.5	49.2	49.9	50.8	51.5	51.9	52.0
66		50.0	55.6	56.8	57.7	58.6	59.3	60.6	61.6	62.5	63.2	63.9	64.8	65.5	65.9	66.0
80		64.0	69.6	70.8	71.7	72.6	73.3	74.6	75.6	76.5	77.2	77.9	78.8	79.5	79.9	80.0
100		84.0	89.6	90.8	91.7	92.6	93.3	94.6	95.6	96.5	97.2	97.9	98.8	99.5	99.9	100.0
		0.00	0.50	0.75	1.00	1.25	1.50	2.00	2.50	3.00	3.50	4.00	5.00	6.00	7.00	8.00
		-	0.91	0.74	0.65	0.58	0.53	0.46	0.42	0.38	0.36	0.34	0.30	0.28	0.26	0.25

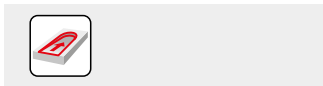

	RPMX	APMX/I
32	25.0	4.0/19
52	8.0	4.0/58
66	6.0	4.0/78
80	4.0	4.0/100
100	3.0	4.0/100

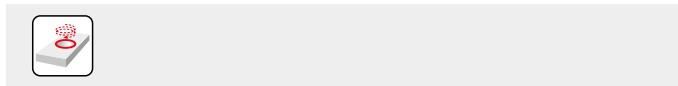

	DMIN	DMAX		
32	34.0	64.0	4.0	4.0
52	74.0	104.0	4.0	4.0
66	102.0	132.0	4.0	4.0
80	130.0	160.0	4.0	4.0
100	170.0	200.0	4.0	4.0

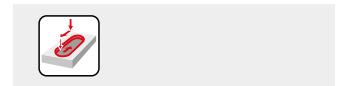

	4.0
--	-----

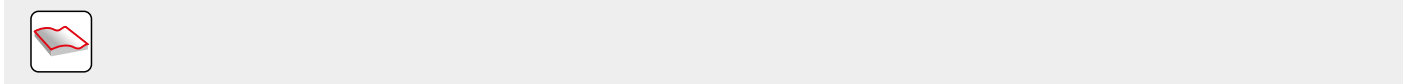



















		3	5	10	15	20	30	40	50	60	80	100
32		0.620	0.800	1.131	1.386	1.600	1.960	2.263	2.530	2.771	3.200	3.578
52		0.790	1.020	1.442	1.766	2.040	2.498	2.884	3.225	3.533	4.079	4.561
66		0.890	1.149	1.625	1.990	2.298	2.814	3.250	3.633	3.980	4.596	5.138
80		0.980	1.265	1.789	2.191	2.530	3.098	3.578	4.000	4.382	5.060	5.657
100		1.095	1.414	2.000	2.449	2.828	3.464	4.000	4.472	4.899	5.657	6.325
		3	5	10	15	20	30	40	50	60	80	100
8.0		0.438	0.566	0.800	0.980	1.131	1.386	1.600	1.789	1.960	2.263	2.530



INDEXABLE MILLS – NAVIGATOR

HIGH FEED MILLING



	SZD07		SZD09		SZD12												
	-		-		-												
	APMX (mm)	1.0	APMX (mm)	1.0	APMX (mm)	1.6											
	DCX (mm)	16 – 32	DCX (mm)	25 – 66	DCX (mm)	32 – 80											
Cylindrical shank		DCX = 16 – 25 (mm)															
Weldon				DCX = 25 – 32 (mm)		DCX = 40 (mm)											
Modular		DCX = 16 – 32 (mm)		DCX = 25 – 42 (mm)		DCX = 32 – 40 (mm)											
Shell mill				DCX = 40 – 66 (mm)		DCX = 50 – 80 (mm)											
Page	397		401		405												
ISO	P	K	H	P	K	H	P	K	H								
Insert shape																	
Inserts	ZDCW 0703		ZDCW 09T3		ZDEW 1204												
No. of cutting edges	4		4		4												
Face milling 	■		■		■												
Helical interpolation 	☑		☑		☑												
Shallow shoulder milling 	☑		☑		☑												
Plunge milling 	☑		☑		☑												
Progressive plunging 	☑		☑		☑												
Ramping 																	
Shape surfaces milling (copy milling) 	☑		☑		☑												
Shallow slot milling 	☑		☑		☑												

■ Primary use ☑ Possible use



SZD07

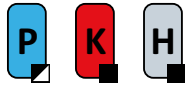

PRAMET



FEED ZD07 High-Feed Milling Cutter with Internal Coolant

Productive high-feed milling cutter utilising single-sided ZD..07 insert with 4 cutting edges and a APMX of 1 mm. Internal coolant. Suitable for a wide range of applications. Available in cylindrical and modular style, in range of Ø16 up to Ø32 mm. Body treated for longer tool life.

FEED ZD

APMX	1.0 mm
------	--------

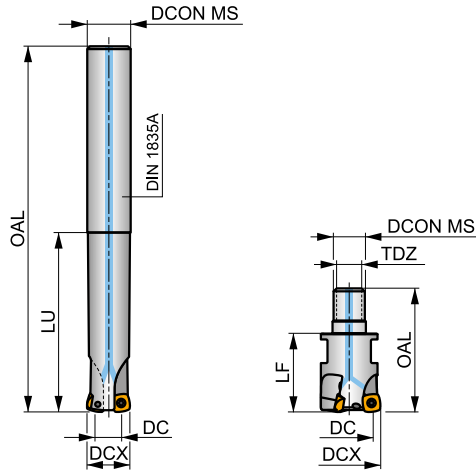
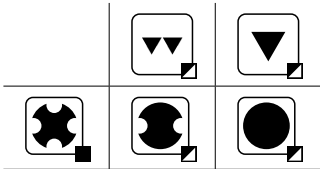
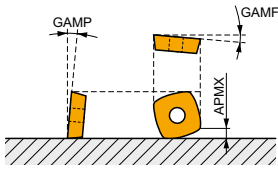

h_m 0.175 - 0.44



Product	DCX (mm)	DC (mm)	OAL (mm)	DCON MS (mm)	LU (mm)	LF (mm)	GAMF (°)	GAMP (°)	max.	kg	GI201	C0350	
16E2R030A16-SZD07	16	6	100	16	30	-	-5	8	2	47400	✓	0.13	GI201 C0350
16E2R065A16-SZD07	16	6	145	16	65	-	-5	8	2	47400	✓	0.19	GI201 C0350
20E3R040A20-SZD07	20	10	120	20	40	-	-5	8	3	42400	✓	0.25	GI201 C0350
20E3R080A20-SZD07	20	10	165	20	80	-	-5	8	3	42400	✓	0.33	GI201 C0350
25E3R050A25-SZD07	25	15	140	25	50	-	-5	8	3	37900	✓	0.47	GI201 C0350
25E3R100A25-SZD07	25	15	190	25	100	-	-5	8	3	37900	✓	0.60	GI201 C0350

GI201	ZDCW 0703..
-------	-------------

C0350	US 2205-T07P	0.9	M 2.2	5	FlagT07P
-------	--------------	-----	-------	---	----------



ZDCW 07

	IC	D1	S
	(mm)	(mm)	(mm)
0703	6.800	2.60	3.18

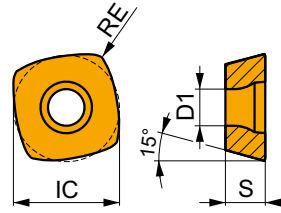

Suitability and starting values for cutting speed (vc), feed (f) and depth of cut (ap). Refer to our Machining Calculator app for further calculations.

Product	RE (mm)	P			M			K			N			S			H		
		vc (m/min)	f (mm/tooth)	ap (mm)	vc (m/min)	f (mm/tooth)	ap (mm)	vc (m/min)	f (mm/tooth)	ap (mm)	vc (m/min)	f (mm/tooth)	ap (mm)	vc (m/min)	f (mm/tooth)	ap (mm)	vc (m/min)	f (mm/tooth)	ap (mm)

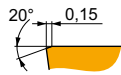
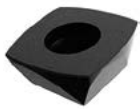

Special geometry for high feed machining.

ZDCW 070304	M8310	0.4	420	0.60	0.4	—	—	—	395	0.60	0.4	—	—	—	—	—	—	—	80	0.42	0.3
	M8325	0.4	325	0.60	0.4	—	—	—	—	—	—	—	—	—	—	—	—	—	—	—	—
	M8345	0.4	305	0.60	0.4	—	—	—	—	—	—	—	—	—	—	—	—	—	—	—	—



a_p DCX	5 %	10 %	15 %	20 %	25 %	30 %	40 %	50 %	60 %	70 %	75 %	80 %	90 %	100 %
	1.48	1.35	1.27	1.22	1.19	1.16	1.11	1.08	1.05	1.03	1.00	1.00	1.00	1.00
	2.20	1.60	1.35	1.20	1.10	0.95	0.85	0.75	0.85	0.95	1.00	1.00	1.00	1.00
	0.64	0.64	0.64	0.64	0.64	0.65	0.65	0.67	0.68	0.71	0.72	0.74	0.79	1.00

ZDCW 07	
	0.4
	-

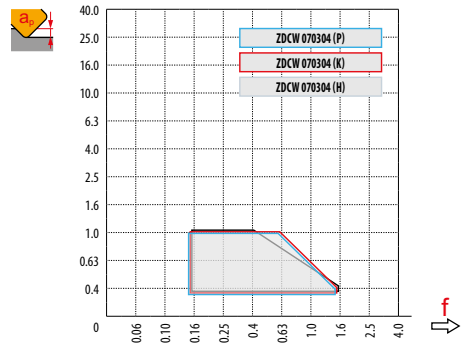

	a_p	0.00	0.30	0.40	0.50	0.60	0.70	0.80	0.90	1.00
16		6.0	12.0	12.9	13.7	14.4	15.1	15.7	16.2	16.8
20		10.0	16.0	16.9	17.7	18.4	19.1	19.7	20.2	20.8
25		15.0	21.0	21.9	22.7	23.4	24.1	24.7	25.2	25.8
32		22.0	28.0	28.9	29.7	30.4	31.1	31.7	32.2	32.8
	a_p	0.00	0.30	0.40	0.50	0.60	0.70	0.80	0.90	1.00
		-	1.50	1.50	1.13	1.00	0.88	0.75	0.61	0.60

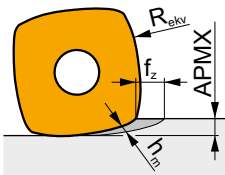

$$f_z = h_m \sqrt{\frac{2R_{ekv}}{APMX}} \quad (\text{mm/tooth})$$



Follow instructions provided for flat surface milling. When milling close to vertical surfaces, decrease feed per tooth (f_z) by 50 % to prevent vibrations and damage of the cutting edge.

	max. f_{max}
16	5.6 0.12
20	5.6 0.15
25	5.6 0.17
32	5.6 0.17

HFC			
a_p	0.3	0.6	1.0
	1.50	0.80	0.40

	RPMX	APMX/I
16	7.8	1.0/9
20	9.7	1.0/7
25	4.9	1.0/13
32	2.8	1.0/22

HFC		
	RPMX	APMX/I
16	0.5	0.75/100
20	0.3	0.40/100
25	0.2	0.20/100
32	0.1	0.05/100



DCX	D _{MIN}	D _{MAX}	S _{MAX} D _{MIN}	S _{MAX} D _{MAX}
16	21.0	32.0	0.10	0.40
20	29.0	40.0	0.10	0.30
25	39.0	50.0	0.15	0.25
32	53.0	64.0	0.10	0.15



DCX	a _p	f _{max}
16	0.05	0.12
20	0.05	0.15
25	0.05	0.17
32	0.05	0.17



DCX	μm	3	5	10	15	20	30	40	50	60	80	100
16	FE	0.438	0.566	0.800	0.980	1.131	1.386	1.600	1.789	1.960	2.263	2.530
20		0.490	0.632	0.894	1.095	1.265	1.549	1.789	2.000	2.191	2.530	2.828
25		0.548	0.707	1.000	1.225	1.414	1.732	2.000	2.236	2.449	2.828	3.162
32		0.620	0.800	1.131	1.386	1.600	1.960	2.263	2.530	2.771	3.200	3.578

i

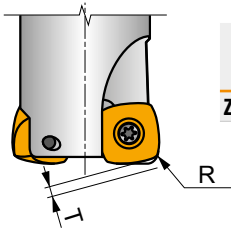

	R	T
ZDCW 070304	1.70	0.60



SZD09

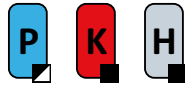

PRAMET



FEED ZD09 High-Feed Milling Cutter with Internal Coolant

Productive high-feed milling cutter utilising single-sided ZD..09 insert with 4 cutting edges and APMX of 1 mm. Internal coolant. Suited for a wide range of applications. Available in cylindrical, modular and arbor style, in range of Ø25 up to Ø66 mm. Body treated for longer tool life.

FEED ZD

APMX	1.0 mm
------	--------

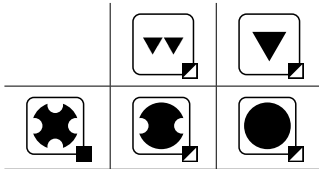
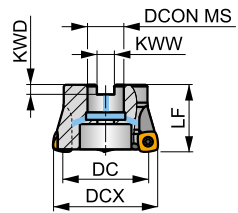
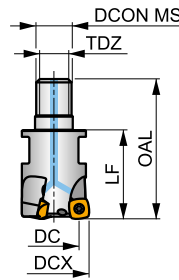
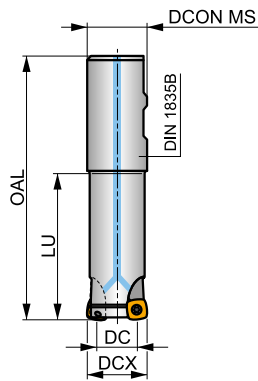
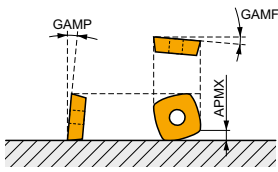

	0.31 - 0.618
	0.31 - 0.618



Product	DCX	DC	OAL	DCON MS	LU	LF	TDZ	KWW	KWD	GAMF	GAMP	Coolant		max.	kg	Tools		
	(mm)	(mm)	(mm)	(mm)	(mm)	(mm)	(mm)	(mm)	(mm)	(°)	(°)	✓	✗					
25E2R080B25-SZD09-C	25	11.6	140	25	80	-	-	-	-	-6	10	2	-	22800	✓	0.49	GI191	SQ400
25E2R140B25-SZD09-C	25	11.6	200	25	140	-	-	-	-	-6	10	2	-	22800	✓	0.63	GI191	SQ400
32E2R240B25-SZD09-C	25	11.6	300	25	240	-	-	-	-	-6	10	2	-	22800	✓	0.90	GI191	SQ400
32E2R080B32-SZD09-C	32	18.7	140	32	80	-	-	-	-	-6	10	2	-	20100	✓	0.80	GI191	SQ400
32E2R140B32-SZD09-C	32	18.7	200	32	140	-	-	-	-	-6	10	2	-	20100	✓	1.07	GI191	SQ400
25E3R032M12-SZD09-C	25	11.6	54	12.5	-	32	M12	-	-	-6	10	2	-	-	✓	0.15	GI191	SQ400
25E3R032M12-SZD09-C	25	11.6	54	12.5	-	32	M12	-	-	-6	10	3	-	-	✓	0.14	GI191	SQ400
32E3R040M16-SZD09-C	32	18.7	63	17	-	40	M16	-	-	-6	10	3	-	-	✓	0.26	GI191	SQ400
35E4R040M16-SZD09-C	35	21.7	63	17	-	40	M16	-	-	-6	10	4	✓	-	✓	0.22	GI191	SQ400
40A04R-SMOZD09-C	40	26.7	-	16	-	40	-	8.4	5.6	-6	10	4	✓	18000	✓	0.44	GI191	SQ402
50A05R-SMOZD09-C	50	36.7	-	22	-	40	-	10.4	6.4	-6	10	5	✓	16000	✓	0.43	GI191	SQ403
63A06R-SMOZD09-C	63	49.7	-	22	-	40	-	10.4	6.4	-6	10	6	✓	14300	✓	0.60	GI191	SQ403

	GI191		ZDCW 09T3..
--	-------	--	-------------

SQ400	US 3006-T09P	2.0	M 3	6	-	-	Flag T09P	-
SQ402	US 3006-T09P	2.0	M 3	6	D-T07P/T09P	FG-15	-	HS 0830C
SQ403	US 3006-T09P	2.0	M 3	6	D-T07P/T09P	FG-15	-	HS 1030C



ZDCW 09

	IC	D1	S
	(mm)	(mm)	(mm)
09T3	9.525	3.40	3.97

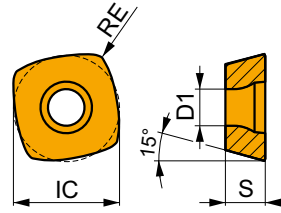

Suitability and starting values for cutting speed (vc), feed (f) and depth of cut (ap). Refer to our Machining Calculator app for further calculations.

Product	RE (mm)	P			M			K			N			S			H		
		vc (m/min)	f (mm/tooth)	ap (mm)	vc (m/min)	f (mm/tooth)	ap (mm)	vc (m/min)	f (mm/tooth)	ap (mm)	vc (m/min)	f (mm/tooth)	ap (mm)	vc (m/min)	f (mm/tooth)	ap (mm)	vc (m/min)	f (mm/tooth)	ap (mm)

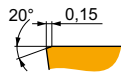

Special geometry for high feed machining.

ZDCW 09T304	M8310	0.4	320	1.00	0.6	-	-	-	300	1.00	0.6	-	-	-	-	-	-	60	0.70	0.4
	M8325	0.4	250	1.00	0.6	-	-	-	-	-	-	-	-	-	-	-	-	-	-	-
	M8345	0.4	235	1.00	0.6	-	-	-	-	-	-	-	-	-	-	-	-	-	-	-



a_e DCX	5 %	10 %	15 %	20 %	25 %	30 %	40 %	50 %	60 %	70 %	75 %	80 %	90 %	100 %
	1.48	1.35	1.27	1.22	1.19	1.16	1.11	1.08	1.05	1.03	1.00	1.00	1.00	1.00
	2.20	1.60	1.35	1.20	1.10	0.95	0.85	0.75	0.85	0.95	1.00	1.00	1.00	1.00
	0.64	0.64	0.64	0.64	0.64	0.65	0.65	0.67	0.68	0.71	0.72	0.74	0.79	1.00

ZDCW 09	
	0.4
	-

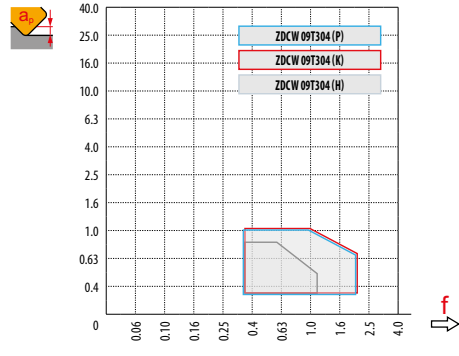

DCX	a_e	0.00	0.30	0.40	0.50	0.60	0.70	0.80	0.90	1.00
25		11.6	17.4	18.2	19.0	19.7	20.3	20.9	21.5	22.0
32		18.7	24.5	25.3	26.1	26.8	27.4	28.0	28.6	29.1
35		21.7	27.3	28.1	28.8	29.5	30.1	30.7	31.2	31.7
40		27.7	33.5	34.3	35.1	35.8	36.4	37.0	37.6	38.1
42		28.7	34.3	35.1	35.8	36.5	37.1	37.7	38.2	38.7
50		36.7	42.3	43.1	43.8	44.5	45.1	45.7	46.2	46.7
52		38.7	44.3	45.1	45.8	46.5	47.1	47.7	48.2	48.7
63		49.7	55.3	56.1	56.8	57.5	58.1	58.7	59.2	59.7
66	52.7	58.3	59.1	59.8	60.5	61.1	61.7	62.2	62.7	
	a_e	0.00	0.30	0.40	0.50	0.60	0.70	0.80	0.90	1.00
	f	-	2.00	2.00	2.00	1.75	1.50	1.25	1.13	1.00

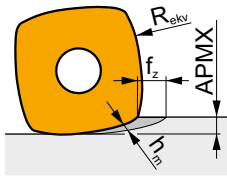

$$f_z = h_m \sqrt{\frac{2R_{ekv}}{APMX}} \quad (\text{mm/tooth})$$



Follow instructions provided for flat surface milling. When milling close to vertical surfaces, decrease feed per tooth (f_z) by 50 % to prevent vibrations and damage of the cutting edge.



DCX	a_p	f_{max}
25	7.7	0.15
32	7.7	0.17
40	7.7	0.20



	HFC		
a_p	0.3	0.6	1.0
f_z	2.00	1.50	1.00



	HFC			
DCX	RPMX	APMX/l	RPMX	APMX/l
25	12.0	1.0/6	0.9	1.00/65
32	7.5	1.0/11	0.5	0.75/100
40	3.6	1.0/17	0.4	0.55/100



DCX	DMIN	DMAX	$f_{z,SMAX}$ DMIN	$f_{z,SMAX}$ DMAX
25	35.0	50.0	0.45	1.00
32	49.0	64.0	0.45	0.85
40	65.0	80.0	0.50	0.85



DCX	a_p	f_{max}
25	0.15	0.15
32	0.15	0.17
40	0.15	0.20



DCX	μm	3	5	10	15	20	30	40	50	60	80	100
25		0.548	0.707	1.000	1.225	1.414	1.732	2.000	2.236	2.449	2.828	3.162
32		0.620	0.800	1.131	1.386	1.600	1.960	2.263	2.530	2.771	3.200	3.578
35		0.648	0.837	1.183	1.449	1.673	2.049	2.366	2.646	2.898	3.347	3.742
40		0.693	0.894	1.265	1.549	1.789	2.191	2.530	2.828	3.098	3.578	4.000
42		0.710	0.917	1.296	1.587	1.833	2.245	2.592	2.898	3.175	3.666	4.099
52		0.790	1.020	1.442	1.766	2.040	2.498	2.884	3.225	3.533	4.079	4.561
63		0.869	1.122	1.587	1.944	2.245	2.750	3.175	3.550	3.888	4.490	5.020
66		0.890	1.149	1.625	1.990	2.298	2.814	3.250	3.633	3.980	4.596	5.138

i

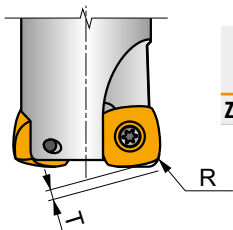

	R	T
ZDCW 09T304	2.27	0.52



SZD12

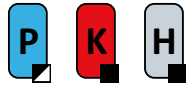

PRAMET

S



FEED ZD12 High-Feed Milling Cutter with Internal Coolant

Highly productive high-feed milling cutter utilising single-sided ZD.. 12 insert with 4 cutting edges and APMX of 1.6 mm. Internal coolant. Suitable for a wide range of applications. Available in cylindrical, modular and arbor style, in range of Ø32 up to Ø80 mm. Body treated for longer tool life.

FEED ZD

APMX	1.6 mm
------	--------

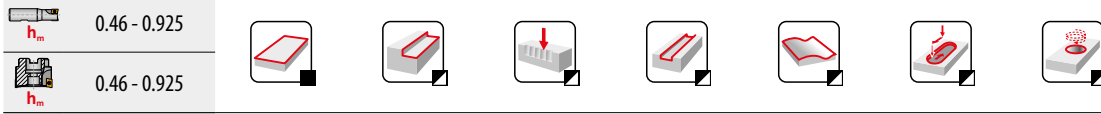
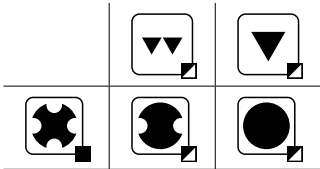
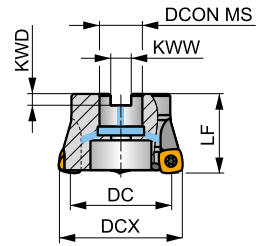
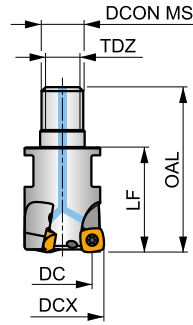
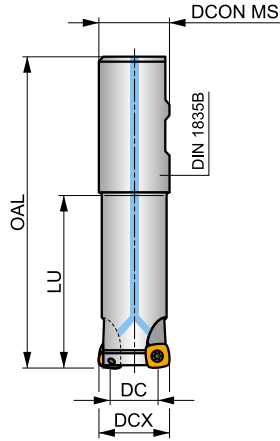
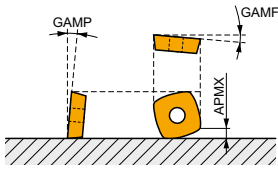

Product	DCX	DC	OAL	DCON MS	LU	LF	TDZ	KWW	KWD	GAMF	GAMP	max.	kg	GI192	SQ220	SQ033	AC001		
	(mm)	(mm)	(mm)	(mm)	(mm)	(mm)	(mm)	(mm)	(mm)	(°)	(°)								
32E3R040M16-SZD12-C	32	14.5	63	17	-	40	M16	-	-	-6	10	3	-	✓	0.24	GI192	SQ220	-	
40E4R040M16-SZD12-C	40	22.5	63	17	-	40	M16	-	-	-6	10	4	-	✓	0.23	GI192	SQ220	-	
50A04R-SMOZD12-C	50	32.5	-	22	-	40	-	10.4	6.4	-6	10	4	✓	14000	✓	0.47	GI192	SQ033	-
63A05R-SMOZD12-C	63	45.5	-	22	-	40	-	10.4	6.4	-6	10	5	✓	12500	✓	0.63	GI192	SQ033	-
80A05R-SMOZD12-C	80	62.5	-	27	-	50	-	12	7	-6	10	5	✓	11100	✓	1.12	GI192	C0371	AC001

	GI192		ZDEW 1204..
--	-------	--	-------------

C0371	US 4011-T15P	3.5	M 4	10.6	D-T08P/T15P	FG-15	-	-
SQ033	US 4011-T15P	3.5	M 4	10.6	D-T08P/T15P	FG-15	-	HS 1030C
SQ220	US 4011-T15P	3.5	M 4	10.6	-	-	FlagT15P	-

AC001	KS 1230	K.FMH27



ZDEW 12

	IC	D1	S
	(mm)	(mm)	(mm)
1204	12.700	4.40	4.76

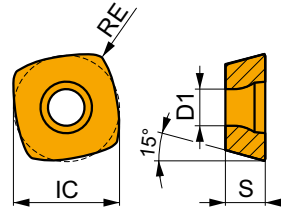

Suitability and starting values for cutting speed (vc), feed (f) and depth of cut (ap). Refer to our Machining Calculator app for further calculations.

Product	RE (mm)	P			M			K			N			S			H		
		vc (m/min)	f (mm/tooth)	ap (mm)	vc (m/min)	f (mm/tooth)	ap (mm)	vc (m/min)	f (mm/tooth)	ap (mm)	vc (m/min)	f (mm/tooth)	ap (mm)	vc (m/min)	f (mm/tooth)	ap (mm)	vc (m/min)	f (mm/tooth)	ap (mm)

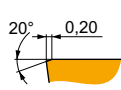
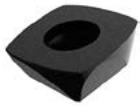

Special geometry for high feed machining.

ZDEW 120408	M8310	0.8	270	1.00	1.0	—	—	—	255	1.00	1.0	—	—	—	—	—	—	—	50	0.70	0.7
	M8325	0.8	205	1.00	1.0	—	—	—	—	—	—	—	—	—	—	—	—	—	—	—	—
	M8345	0.8	195	1.00	1.0	—	—	—	—	—	—	—	—	—	—	—	—	—	—	—	—



a_e DCX	5 %	10 %	15 %	20 %	25 %	30 %	40 %	50 %	60 %	70 %	75 %	80 %	90 %	100 %
	1.48	1.35	1.27	1.22	1.19	1.16	1.11	1.08	1.05	1.03	1.00	1.00	1.00	1.00
	2.20	1.60	1.35	1.20	1.10	0.95	0.85	0.75	0.85	0.95	1.00	1.00	1.00	1.00
	0.64	0.64	0.64	0.64	0.64	0.65	0.65	0.67	0.68	0.71	0.72	0.74	0.79	1.00

ZDEW 12	
	0.8
	-

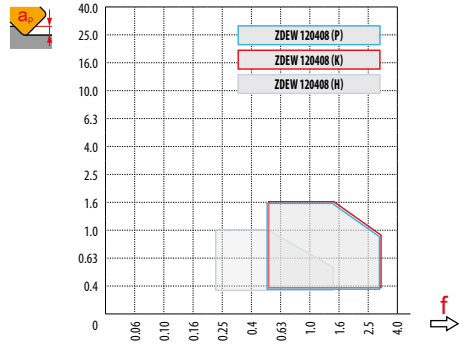

		0.00	0.50	0.60	0.70	0.80	0.90	1.00	1.10	1.20	1.30	1.40	1.50	1.60
32		14.5	22.7	23.5	24.2	24.8	25.4	26.0	26.5	27.0	27.5	28.0	28.5	28.9
40		22.5	30.7	31.5	32.2	32.8	33.4	34.0	34.5	35.0	35.5	36.0	36.5	36.9
50		32.5	40.7	41.5	42.2	42.8	43.4	44.0	44.5	45.0	45.5	46.0	46.5	46.9
52		34.5	42.7	43.5	44.2	44.8	45.4	46.0	46.5	47.0	47.5	48.0	48.5	48.9
63		45.5	53.7	54.5	55.2	55.8	56.4	57.0	57.5	58.0	58.5	59.0	59.5	59.9
66		48.5	56.7	57.5	58.2	58.8	59.4	60.0	60.5	61.0	61.5	62.0	62.5	62.9
80		62.5	70.7	71.5	72.2	72.8	73.4	74.0	74.5	75.0	75.5	76.0	76.5	76.9
		0.00	0.50	0.60	0.70	0.80	0.90	1.00	1.10	1.20	1.30	1.40	1.50	1.60
		-	3.00	3.00	3.00	3.00	3.00	3.00	2.50	2.25	2.00	1.80	1.65	1.50

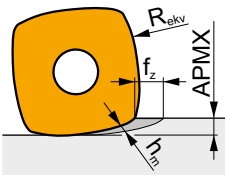

$$f_z = h_m \sqrt{\frac{2R_{ekv}}{APMX}} \quad (\text{mm/tooth})$$





Follow instructions provided for flat surface milling. When milling close to vertical surfaces, decrease feed per tooth (f_z) by 50 % to prevent vibrations and damage of the cutting edge.

DCX	max	f _{max}
32	10.0	0.15
40	10.0	0.17
50	10.0	0.20
52	10.0	0.20
63	10.0	0.20
66	10.0	0.20
80	10.0	0.25





HFC			
	0.5	1.0	1.6
	3.00	2.00	1.50





		HFC		
DCX	RPMX	APMX/I	RPMX	APMX/I
32	10	1.6/11	1.2	1.60/78
40	5.5	1.6/18	0.7	1.10/100
50	3.3	1.6/29	0.5	0.75/100
52	3.1	1.6/31	0.5	0.75/100
63	2.2	1.6/43	0.3	0.40/100
66	2.0	1.6/47	0.3	0.40/100
80	1.5	1.6/63	0.2	0.20/100





DCX	DMIN	DMAX		
32	44.0	64.0	0.75	1.60
40	60.0	80.0	0.75	1.50
50	80.0	100.0	0.80	1.35
52	84.0	104.0	0.80	1.35
63	106.0	126.0	0.70	1.00
66	112.0	132.0	0.70	1.00
80	140.0	160.0	0.65	0.85



DCX		f _{max}
32	0.25	0.15
40	0.25	0.17
50	0.25	0.20
52	0.25	0.20
63	0.25	0.20
66	0.25	0.20
80	0.25	0.25



DCX		3	5	10	15	20	30	40	50	60	80	100
32		0.620	0.800	1.131	1.386	1.600	1.960	2.263	2.530	2.771	3.200	3.578
40		0.693	0.894	1.265	1.549	1.789	2.191	2.530	2.828	3.098	3.578	4.000
50		0.775	1.000	1.414	1.732	2.000	2.449	2.828	3.162	3.464	4.000	4.472
52		0.790	1.020	1.442	1.766	2.040	2.498	2.884	3.225	3.533	4.079	4.561
63		0.869	1.122	1.587	1.944	2.245	2.750	3.175	3.550	3.888	4.490	5.020
66		0.890	1.149	1.625	1.990	2.298	2.814	3.250	3.633	3.980	4.596	5.138
80		0.980	1.265	1.789	2.191	2.530	3.098	3.578	4.000	4.382	5.060	5.657

i

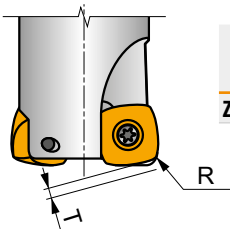









	R	T
ZDEW 120408	3.52	0.64



CHAMFER, T-SLOT MILLING



	J(T)-SXP16				
	15° – 75°				
	APMX (mm)	7.0 – 28.0			
	DC (mm)	35 – 45			
Cylindrical shank					
Weldon					
Morse					
Shell mill					
Page	 41				
ISO	P	M	K	N	
Insert shape					
Inserts	XPHT 1604				
No. of cutting edges	2				
Chamfer milling		■			
Rear face milling					
T-slot milling					
Shallow shoulder milling					
Shallow slot milling					



J(T)-SXP16



PRAMET

S



Long Edge Chamfer Milling Cutter for XPHT 16 insert with Internal Coolant

Chamfer milling cutter utilising single-sided XPHT 16 inserts with APMX from 7 up to 28 mm. Internal coolant. Suitable for top chamfering. Available in arbor style only. Minor Ø35 and Ø45 mm, in range of 15°, 25°, 30°, 35°, 40°, 45°, 50°, 55°, 60° and 75° chamfer angle. Body treated for longer tool life.

KAPR	15° - 75°
APMX	7.0 - 28.0 mm

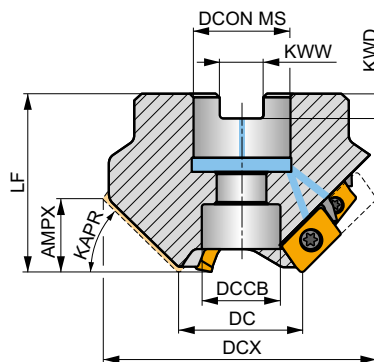
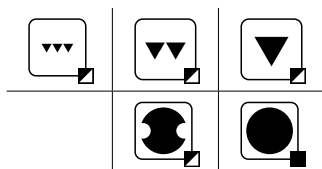
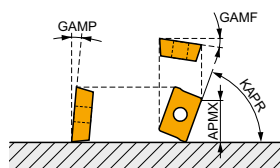

0.05 - 0.11



Product	DC (mm)	DCX (mm)	LF (mm)	DCON MS (mm)	DCCB (mm)	KAPR (°)	KWW (mm)	KWD (mm)	APMX (mm)	GAMF (°)	GAMP (°)	NOF						
35T03R-S15XP1607-C	35	90.6	50	27	22	15	12.4	7	7.00	-6	-1	3	6	-	15200	✓	1.38	G1208 CH050
35T03R-S25XP1612-C	35	87.3	50	27	22	25	12.4	7	12.00	-6	0	3	6	-	15200	✓	1.24	G1208 CH050
35T03R-S30XP1614-C	35	85.1	50	27	22	30	12.4	7	14.00	-6	0	3	6	-	15200	✓	1.28	G1208 CH050
35T03R-S35XP1616-C	35	82.4	50	27	22	35	12.4	7	16.00	-6	0	3	6	-	15200	✓	1.15	G1208 CH050
35T03R-S40XP1618-C	35	79.4	50	27	22	40	12.4	7	18.00	-6	1	3	6	-	15200	✓	1.07	G1208 CH050
35T03R-S45XP1620-C	35	76.1	50	27	22	45	12.4	7	20.00	-6	2	3	6	-	15200	✓	0.97	G1208 CH050
35T03R-S50XP1622-C	35	72.4	50	27	22	50	12.4	7	22.00	-6	2	3	6	-	15200	✓	0.91	G1208 CH050
35T03R-S55XP1623-C	35	68.4	50	27	22	55	12.4	7	23.00	-6	2	3	6	-	15200	✓	0.83	G1208 CH050
35T03R-S60XP1625-C	35	64.2	50	27	22	60	12.4	7	25.00	-5	4	3	6	-	15200	✓	0.67	G1208 CH050
45T03R-S75XP1628-C	45	60.1	50	27	22	75	12.4	7	28.00	-5	5	3	6	-	13400	✓	0.73	G1208 CH050
45T04R-S25XP1612-C	45	97.3	50	27	22	25	12.4	7	12.00	-6	0	4	8	✓	13400	✓	1.63	G1208 CH050
45T04R-S30XP1614-C	45	95.1	50	27	22	30	12.4	7	14.00	-6	0	4	8	✓	13400	✓	1.22	G1208 CH050
45T04R-S35XP1616-C	45	92.4	50	27	22	35	12.4	7	16.00	-6	2	4	8	✓	13400	✓	1.30	G1208 CH050
45T04R-S40XP1618-C	45	89.5	50	27	22	40	12.4	7	18.00	-6	2	4	8	✓	13400	✓	1.18	G1208 CH050
45T04R-S45XP1620-C	45	86.1	50	27	22	45	12.4	7	20.00	-6	2	4	8	✓	13400	✓	1.11	G1208 CH050
45T04R-S50XP1622-C	45	82.4	50	27	22	50	12.4	7	22.00	-6	2	4	8	✓	13400	✓	1.04	G1208 CH050
45T04R-S55XP1623-C	45	78.4	50	27	22	55	12.4	7	23.00	-6	2	4	8	✓	13400	✓	0.96	G1208 CH050
45T04R-S60XP1625-C	45	74.2	50	27	22	60	12.4	7	25.00	-5	4	4	8	✓	13400	✓	0.82	G1208 CH050



G1208



XPHT 1604..



CH050



US 3509-T15



3.0



M 3.5



9



D-T07/T15



FG-15



HS 1230C



XPHT 16

	W1	D1	L	S
	(mm)	(mm)	(mm)	(mm)
1604	9.525	4.40	15.88	4.76

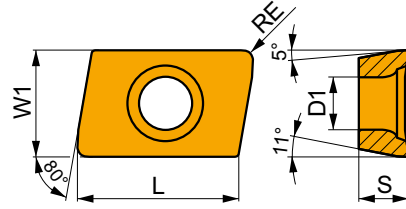

Suitability and starting values for cutting speed (vc), feed (f) and depth of cut (ap). Refer to our Machining Calculator app for further calculations.

Product	RE (mm)	P			M			K			N			S			H		
		vc (m/min)	f (mm/tooth)	ap (mm)	vc (m/min)	f (mm/tooth)	ap (mm)	vc (m/min)	f (mm/tooth)	ap (mm)	vc (m/min)	f (mm/tooth)	ap (mm)	vc (m/min)	f (mm/tooth)	ap (mm)	vc (m/min)	f (mm/tooth)	ap (mm)

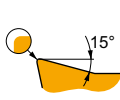

E geometry with highly positive design for chamfer milling.

XPHT 160412E	8215	1.2	225	0.10	15.0	135	0.09	15.0	210	0.10	15.0	-	-	-	-	-	-	-
	M6330	1.2	190	0.10	15.0	135	0.09	15.0	-	-	-	-	-	-	-	-	-	-
	M8330	1.2	220	0.10	15.0	130	0.09	15.0	205	0.10	15.0	-	-	-	-	-	-	-
	M8340	1.2	195	0.10	15.0	115	0.09	15.0	185	0.10	15.0	-	-	-	-	-	-	-

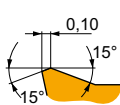

S geometry with highly positive design for chamfer milling.

XPHT 160412S	8215	1.2	210	0.12	15.0	125	0.11	15.0	195	0.12	15.0	-	-	-	-	-	-
	M8330	1.2	210	0.12	15.0	125	0.11	15.0	195	0.12	15.0	-	-	-	-	-	-
	M8340	1.2	190	0.12	15.0	110	0.11	15.0	180	0.12	15.0	-	-	-	-	-	-
	M9325	1.2	270	0.12	15.0	-	-	-	255	0.12	15.0	-	-	-	-	-	-
	M9340	1.2	245	0.12	15.0	145	0.11	15.0	-	-	-	-	-	-	-	-	-

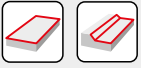

	XPHT 16 E	XPHT 16 S
	1.2	1.2
	-	-

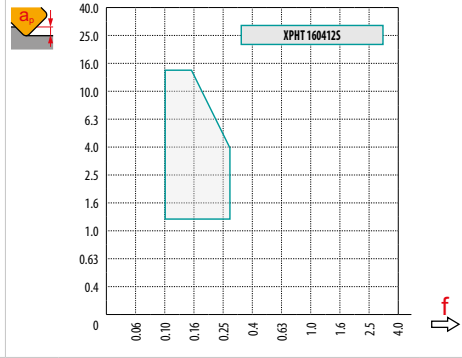
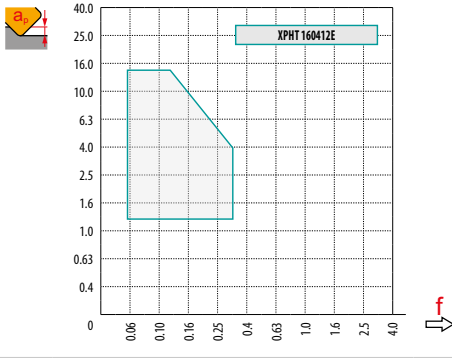

a_e / DC	0.10	0.15	0.20	0.25	0.30	0.35	0.40	0.50 - 1.00																
	f																							
15°	0.61	0.98	1.34	0.50	0.80	1.10	0.43	0.69	0.95	0.39	0.62	0.85	0.35	0.56	0.78	0.33	0.52	0.72	0.31	0.49	0.67	0.27	0.44	0.60
25°	0.37	0.60	0.82	0.31	0.49	0.67	0.26	0.42	0.58	0.24	0.38	0.52	0.22	0.35	0.48	0.20	0.32	0.44	0.19	0.30	0.41	0.17	0.27	0.37
30°	0.32	0.51	0.70	0.26	0.41	0.57	0.22	0.36	0.49	0.20	0.32	0.44	0.18	0.29	0.40	0.17	0.27	0.37	0.16	0.25	0.35	0.14	0.23	0.31
35°	0.28	0.44	0.61	0.23	0.36	0.50	0.19	0.31	0.43	0.17	0.28	0.38	0.16	0.25	0.35	0.15	0.24	0.32	0.14	0.22	0.30	0.12	0.20	0.27
40°	0.25	0.39	0.54	0.20	0.32	0.44	0.17	0.28	0.38	0.16	0.25	0.34	0.14	0.23	0.31	0.13	0.21	0.29	0.12	0.20	0.27	0.11	0.18	0.24
45°	0.22	0.36	0.49	0.18	0.29	0.40	0.16	0.25	0.35	0.14	0.23	0.31	0.13	0.21	0.28	0.12	0.19	0.26	0.11	0.18	0.25	0.10	0.16	0.22
50°	0.21	0.33	0.45	0.17	0.27	0.37	0.15	0.23	0.32	0.13	0.21	0.29	0.12	0.19	0.26	0.11	0.18	0.24	0.10	0.17	0.23	0.09	0.15	0.20
55°	0.19	0.31	0.42	0.16	0.25	0.35	0.14	0.22	0.30	0.12	0.20	0.27	0.11	0.18	0.25	0.10	0.17	0.23	0.10	0.15	0.21	0.09	0.14	0.19
60°	0.18	0.29	0.40	0.15	0.24	0.33	0.13	0.21	0.28	0.12	0.18	0.25	0.11	0.17	0.23	0.10	0.16	0.21	0.09	0.15	0.20	0.08	0.13	0.18
75°	0.16	0.26	0.36	0.13	0.21	0.29	0.12	0.19	0.25	0.10	0.17	0.23	0.09	0.15	0.21	0.09	0.14	0.19	0.08	0.13	0.18	0.07	0.12	0.16
	1.35	1.27	1.22	1.19	1.16	1.13	1.11	1.00																



		DC	DCX		f_{min}	f_{max}
15°	7	35.0	90.6	1.16	0.43	0.70
25°	12	35.0	87.3	1.16	0.20	0.32
30°	14	35.0	85.1	1.17	0.16	0.25
35°	16	35.0	82.4	1.17	0.13	0.20
40°	18	35.0	79.4	1.17	0.11	0.16
45°	20	35.0	76.0	1.18	0.09	0.14
50°	22	35.0	72.4	1.18	0.08	0.12
55°	23	35.0	68.4	1.20	0.08	0.11
60°	25	35.0	64.1	1.20	0.07	0.09
25°	12	45.0	97.3	1.18	0.23	0.34
30°	14	45.0	95.0	1.18	0.18	0.26
35°	16	45.0	92.4	1.19	0.15	0.21
40°	18	45.0	89.5	1.19	0.12	0.17
45°	20	45.0	86.0	1.20	0.11	0.15
50°	22	45.0	82.4	1.21	0.09	0.13

		DC	DCX		f_{min}	f_{max}
55°	23	45.0	78.4	1.22	0.09	0.11
60°	25	45.0	74.1	1.23	0.08	0.10
75°	28	45.0	60.1	1.31	0.07	0.08

Cutters with setting angle 15° can be used as HFC. Use feeds from chamfers table.



TAILOR MADE MILLING INSERTS FOR MACHINING OF SWITCHES, BASE PLATES, DYNAMIC RAIL MILLING AND WHEEL RECONDITIONING

(S-)SNE. 12 – 15 (RE)  414	(S-)SN.. 12; 15 (CHW)  414	(S-)SNE. 12; 15 (KCH)  415	LNE 434  415	513000; LNEQ 28  415
(S-)CN.. 08 – 15  416	(S-)SN.. 12; 15 (RE)  416	(S-)LNE. 13; 15 (RE)  416	(S-)SN../(S-)LNEQ 12; 15 (RE)  417	(S-)SN.. 15 (CEMR)  417
(S-)SN.. 12; 15 (CEMR)  418	(S-)XOEX 12  418	(S-)LDEX 12; 13 (CEMR)  419	S-CDEW 11/(S-)XDE. 12 – 16  419	(S-)SN.. 12; 16 (CEMR)  420
SNXN 13  421	SNEX 13; 15 (CEMR)  421	(S-)SNEX 13 – 27  422	(S-)SP.X 12 – 27  423	(S-)SN.Q 15  424
S-LNEX 15  424	(S-)LPGX 27  425	(S-)SP.W 14 – 19  425	S-SPEN 12  426	S-SPEN 12; 15  426
S-RPGN 20  427	(S-)LC 16 – 32  427	(S-)LC 32  428	RNGX 12  428	ROEX 15  429
S-RNEX 15  429	S-RNEX 16  429			



(S-)SNE. 12 – 15 (RE)

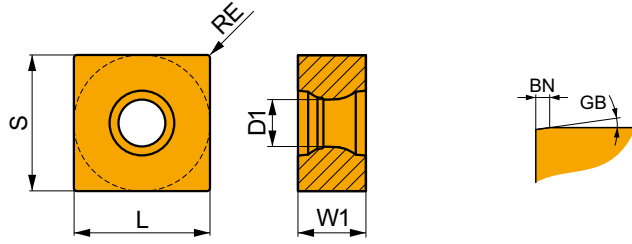

Product	W1	L	S	D1	RE	BN	GB	CEDC	NSIDE	7310	8215	M8310	M8325	M8326	M8330	M8340	M8345	M8346	M9315	M9325	M9340
										(mm)	(mm)	(mm)	(mm)	(mm)	(mm)	(°)					
SNEQ 12-410000	6.35	12.700	12.700	4.4	0.40	0.15	8	8	2	-	-	-	-	-	-	-	-	●	-	●	-
S-SNEQ 12-410000	6.35	12.700	12.700	4.4	0.40	0.15	8	8	2	-	-	-	-	-	○	○	-	-	-	-	○
SNEX 12-2500021	7.94	13.000	13.000	5.5	0.25	-	-	8	2	-	-	-	-	-	-	-	-	-	-	-	-
SNEX 12-2482000	8.20	13.200	13.200	5.5	0.25	-	-	8	2	-	-	-	-	-	-	-	-	-	-	-	-
SNEX 13-2222000	6.35	13.500	13.500	4.4	0.40	-	-	8	2	-	-	-	-	-	-	-	-	-	-	-	-
SNEX 13-2223000	6.46	13.500	13.500	4.4	0.40	-	-	8	2	-	-	-	-	-	-	-	-	-	-	-	-
S-SNEX 13-001317	7.30	13.500	13.500	5.5	0.20	-	-	8	2	○	-	-	-	-	-	-	-	-	-	-	-
SNEX 15-2300000	7.00	15.700	15.700	5.5	0.20	-	-	8	2	○	-	-	-	-	-	-	-	-	-	-	-
S-SNEQ 15-001885	6.35	15.875	15.875	5.6	0.80	0.25	30	8	2	-	-	-	-	-	-	-	○	-	-	-	-
SNEQ 15-520000	7.94	15.875	15.875	5.5	0.40	0.20	15	8	2	-	-	-	-	-	-	-	●	-	●	○	
SNEQ 15-2422000	7.94	15.875	15.875	5.5	0.40	-	-	8	2	●	-	-	-	-	-	-	-	-	-	-	-

(S-)SN.. 12; 15 (CHW)

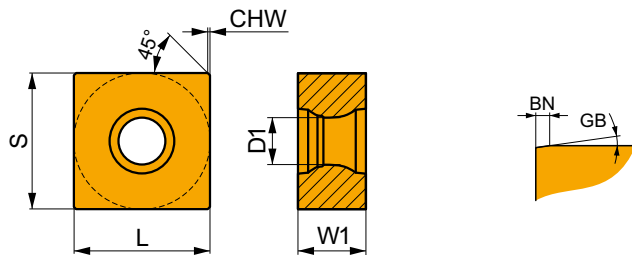

Product	W1	L	S	D1	CHW	BN	GB	CEDC	NSIDE	7310	8215	M8310	M8325	M8326	M8330	M8340	M8345	M8346	M9315	M9325	M9340
										(mm)	(mm)	(mm)	(mm)	(mm)	(mm)	(°)					
SNEQ 12-1118000	6.35	12.700	12.700	4.40	0.4	0.140	15	8	2	-	-	-	-	-	-	-	-	-	-	○	-
SNEX 12-2118000	6.35	12.700	12.700	4.40	0.5	-	-	8	2	-	-	○	-	-	-	-	-	-	-	-	-
SNEX 12-2431000	6.35	12.700	12.700	4.40	0.5	0.050	3	8	2	-	-	-	-	-	-	-	○	-	-	-	-
S-SNEX 12-2431000	6.35	12.700	12.700	4.40	0.5	0.050	3	8	2	-	-	-	-	-	○	-	-	-	-	-	○
S-SNXQ 12-001847	6.35	12.700	12.700	5.30	-	0.824	20	8	2	-	-	-	-	-	-	-	○	-	-	-	-
SNXQ 12-1601000	7.94	12.700	12.700	5.50	0.2	-	-	8	2	-	-	-	-	-	-	-	-	-	-	●	-
S-SNEX 15-2462000	7.94	15.000	15.000	4.40	0.5	-	-	8	2	●	-	-	-	-	-	-	-	-	-	-	-
S-SNEQ 15-001886	5.56	15.875	15.875	5.55	-	0.350	25	8	2	-	-	-	-	-	-	-	○	-	-	-	-
SNEA 15-2019000	7.94	15.875	15.875	5.30	0.5	-	-	8	2	-	-	○	-	-	-	-	-	-	-	-	-
S-SNEA 15-2019000	7.94	15.875	15.875	5.30	0.5	-	-	8	2	-	-	-	-	-	-	-	-	○	-	-	-
SNEQ 15-2501252	7.94	15.875	15.875	5.50	0.5	0.050	3	8	2	-	-	-	-	-	-	-	-	○	-	○	○

● stocked ○ non-stocked — upon request



(S-)SNE. 12; 15 (KCH)

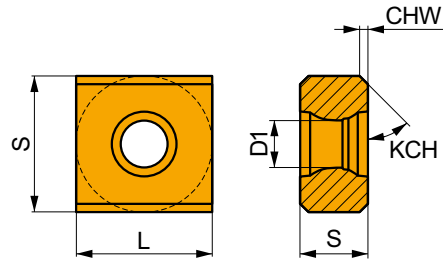

Product	W1	L	S	D1	CHW	KCH	CEDC	NSIDE	7310	8215	M8310	M8325	M8326	M8330	M8340	M8345	M8346	M9315	M9325	M9340	
	(mm)	(mm)	(mm)	(mm)	(mm)	(°)															
S-SNEQ 12-000419	6.35	12.700	12.700	4.4	0.8	45	4	2	—	—	—	—	—	—	—	—	●	—	○	—	—
SNEQ 15-2421000	7.94	15.875	15.875	5.3	0.8	45	4	2	—	—	—	—	—	—	—	—	—	—	—	—	—

LNE 434

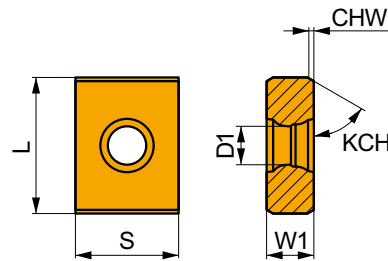

Product	W1	L	S	D1	CHW	KCH	CEDC	NSIDE	7310	8215	M8310	M8325	M8326	M8330	M8340	M8345	M8346	M9315	M9325	M9340	
	(mm)	(mm)	(mm)	(mm)	(mm)	(°)															
LNE 434-100	6.35	19.05	14.29	5.5	0.75	30	4	2	—	—	—	●	—	—	○	—	○	—	—	—	—

513000; LNEQ 28

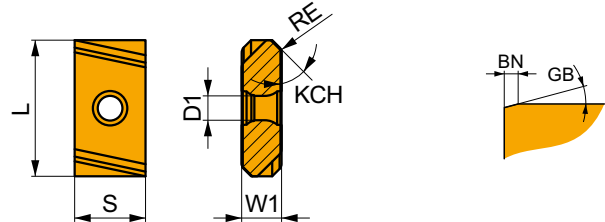

Product	W1	L	S	D1	RE	KCH	BN	GB	CEDC	NSIDE	7310	8215	M8310	M8325	M8326	M8330	M8340	M8345	M8346	M9315	M9325	M9340	
	(mm)	(mm)	(mm)	(mm)	(mm)	(°)	(mm)	(°)															
513000	7.11	24.13	12.70	4.4	1.2	45	0.20	15	4	2	—	—	—	●	—	—	—	—	○	—	○	—	—
LNEQ 28-1821000	9.52	28.60	14.30	6.5	—	30	—	—	4	2	—	—	—	—	—	—	—	—	—	—	—	—	—
LNEQ 28-2500782	9.52	28.57	15.88	5.6	—	30	0.25	15	4	2	—	—	—	—	—	—	—	—	—	—	—	—	—

(S-)CN.. 08 – 15

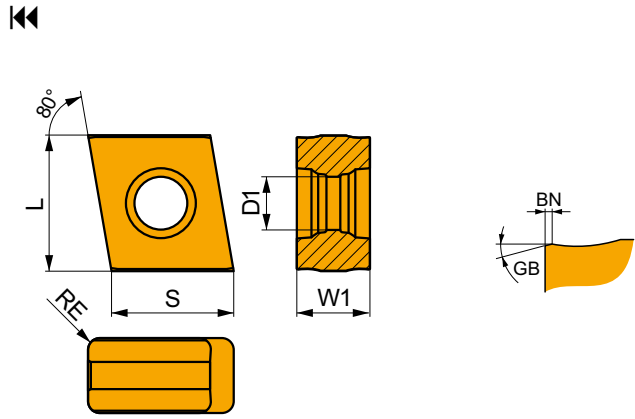

Product	W1 (mm)	L (mm)	S (mm)	D1 (mm)	RE (mm)	BN (mm)	GB (°)	CEDC	NSIDE	7310	8215	M8310	M8325	M8326	M8330	M8340	M8345	M8346	M9315	M9325	M9340	
										-	-	-	○	-	-	-	-	-	○	-	-	-
CNHU 08-1691000	5.00	9.1	7.90	3.5	0.8	0.10	12	4	2	-	-	-	○	-	-	-	-	-	-	-	-	-
CNHU 08-2044000	5.00	9.1	7.90	3.5	0.8	0.10	12	4	2	-	-	-	-	-	-	-	-	-	-	-	-	-
S-CNHU 08-1691000	5.00	9.1	7.90	3.5	0.8	0.10	12	4	2	-	-	-	-	-	-	-	-	○	-	-	-	-
CNHU 08-1345000	5.00	8.1	8.90	3.5	0.8	0.15	12	4	2	-	-	-	-	-	-	-	-	-	-	-	-	-
CNE 635-600000	6.35	12.9	11.95	4.4	0.4	0.10	15	4	2	-	-	-	●	-	-	-	-	-	-	-	-	-
CNE 635-635000	6.35	12.9	12.70	4.4	1.2	0.10	15	4	2	-	-	-	-	-	-	-	-	○	-	-	-	-
CNM 563	8.00	16.2	15.00	5.5	1.2	0.10	0	4	2	-	○	-	-	-	○	○	○	-	-	-	-	-

(S-)SN.. 12; 15 (RE)

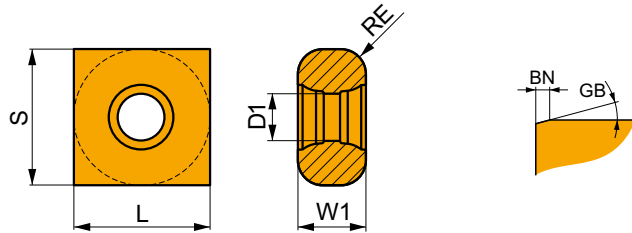

Product	W1 (mm)	L (mm)	S (mm)	D1 (mm)	RE (mm)	BN (mm)	GB (°)	CEDC	NSIDE	7310	8215	M8310	M8325	M8326	M8330	M8340	M8345	M8346	M9315	M9325	M9340	
										-	-	-	-	-	-	-	-	-	-	○	-	-
S-SNCQ 12-000211	6.35	12.700	12.700	4.4	0.8	0.2	15	4	2	-	-	-	-	-	-	-	-	-	-	○	-	-
SNCQ 12-485001	6.35	12.700	12.700	4.4	1.2	0.2	15	4	2	-	-	-	●	-	-	-	-	○	-	-	-	-
S-SNCQ 12-485003	6.35	12.700	12.700	4.4	2.0	0.2	15	4	2	-	○	-	-	-	-	-	-	○	-	-	-	-
SNCQ 12-485002	6.35	12.700	12.700	4.4	3.0	0.2	15	4	2	-	-	-	●	-	-	-	-	○	-	-	-	-
SNEX 15-2501818	7.94	15.000	15.000	4.4	2.0	-	-	4	2	○	-	-	-	-	-	-	-	-	-	○	-	-
SNEQ 15-2501257	7.94	15.875	15.875	5.5	2.0	-	-	4	2	-	-	-	-	-	-	-	-	○	-	-	-	-
S-SNUQ 15-001290	7.94	15.875	15.875	5.5	3.0	0.2	15	4	2	-	-	-	-	-	-	-	-	●	-	-	-	-

(S-)LNE. 13; 15 (RE)

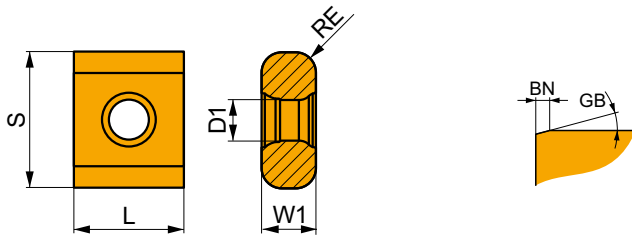

Product	W1 (mm)	L (mm)	S (mm)	D1 (mm)	RE (mm)	BN (mm)	GB (°)	CEDC	NSIDE	7310	8215	M8310	M8325	M8326	M8330	M8340	M8345	M8346	M9315	M9325	M9340	
										-	-	-	-	-	-	-	-	-	-	○	-	-
LNEQ 15-2500104	6.35	15.875	12.7	4.65	2.5	0.15	15	4	2	-	-	-	-	-	-	-	-	○	-	-	-	-
S-LNEX 15-001866	7.94	15.875	12.7	5.90	2.0	-	-	4	2	-	-	-	-	-	-	-	-	○	-	-	-	-
S-LNEQ 13-001368	7.94	15.000	13.5	4.40	2.0	-	-	4	2	○	-	-	-	-	-	-	-	-	-	-	-	-



(S-)SN../(S-)LNEQ 12; 15 (RE)

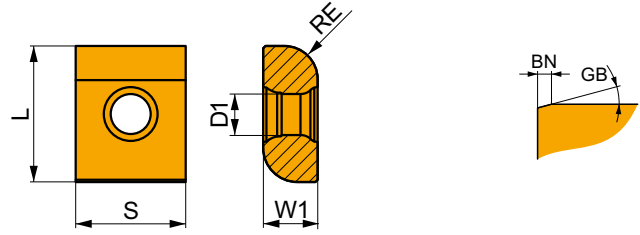

Product	W1 (mm)	L (mm)	S (mm)	D1 (mm)	RE (mm)	BN (mm)	GB (°)	CEDC	NSIDE	7310	8215	M8310	M8325	M8326	M8330	M8340	M8345	M8346	M9315	M9325	M9340	
										—	—	—	—	—	—	—	—	—	—	—	—	—
S-SNXQ 12-001858	6.35	12.700	12.700	5.80	4.00	—	—	4	2	—	—	—	—	—	—	—	—	—	—	—	—	—
S-SNCQ 12-000416	6.35	12.700	12.700	4.40	5.00	0.20	15	4	2	—	—	—	—	—	—	—	—	—	—	—	—	—
LNEQ 15-1389000	6.35	15.875	12.700	4.65	3.00	0.20	15	4	2	—	—	—	○	—	—	—	—	—	—	—	—	—
S-LNEQ 15-2001000	6.35	15.875	12.700	4.65	4.00	0.20	15	4	2	—	—	—	○	—	—	—	—	—	—	—	—	—
S-SNEQ 15-000107	7.94	15.875	15.875	5.50	3.55	0.25	11	4	2	—	—	—	—	—	—	—	—	—	○	—	—	—
SNEQ 15-2501569	7.94	15.875	15.875	5.50	4.00	0.20	15	4	2	—	—	—	—	—	—	—	—	—	○	—	—	—
S-SNEQ 15-000194	7.94	15.875	15.875	5.50	5.00	0.12	15	4	2	—	—	—	—	—	—	—	—	—	○	—	—	—
SNEQ 15-2042000	7.94	15.875	15.875	5.50	6.35	—	—	4	2	—	—	—	—	—	—	—	—	—	—	—	—	—

(S-)SN.. 15 (CEMR)

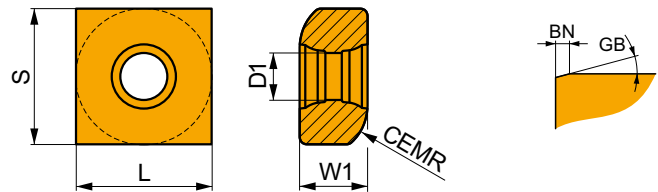

Product	W1 (mm)	L (mm)	S (mm)	D1 (mm)	CEMR (mm)	BN (mm)	GB (°)	CEDC	NSIDE	7310	8215	M8310	M8325	M8326	M8330	M8340	M8345	M8346	M9315	M9325	M9340	
										—	—	—	—	—	—	—	—	—	—	—	—	—
S-SNGX 15-001112	7.94	15.875	15.875	5.5	6	0.2	15	4	2	—	—	—	—	—	—	—	—	—	○	—	—	—
SNGX 15-546000	7.94	15.875	15.875	5.5	7	0.2	15	4	2	—	—	—	—	—	—	—	—	—	●	—	●	—
S-SNEX 15-001874	7.94	15.875	15.875	5.8	7	0.2	15	4	2	—	—	—	—	—	—	—	—	—	○	—	—	—
S-SNEQ 15-001077	7.94	15.875	15.875	5.5	10	—	—	4	2	—	—	—	—	—	—	—	—	—	○	—	—	—



(S-)SN.. 12; 15 (CEMR)

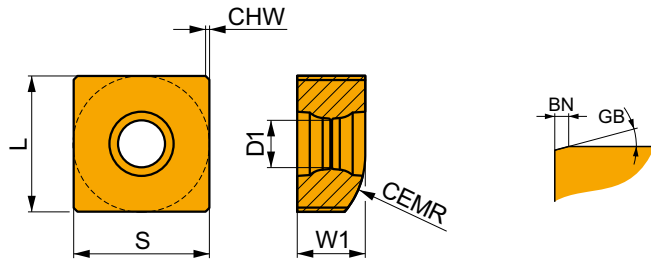

Product	W1	L	S	D1	CEMR	CHW	BN	GB	CEDC	NSIDE	7310	8215	M8310	M8325	M8326	M8330	M8340	M8345	M8346	M9315	M9325	M9340	
											(mm)	(mm)	(mm)	(mm)	(mm)	(mm)	(°)						
SNCQ 12-487001	6.35	12.700	12.700	4.4	20.0	—	0.2	15	2	1	—	—	—	●	—	—	—	—	—	—	○	—	—
S-SNCQ 12-487001	6.35	12.700	12.700	4.4	20.0	—	0.2	15	2	1	—	—	—	—	—	—	—	—	○	—	—	—	
S-SNEX 15-001863	5.56	15.875	15.875	5.5	6.0	—	—	—	2	1	—	—	—	—	—	—	—	—	○	—	—	—	
SNCQ 15-489006	7.94	15.875	15.875	5.5	8.0	—	0.2	15	2	1	—	—	—	—	—	—	—	—	○	—	—	—	
S-SNCQ 15-000778	7.94	15.875	15.875	5.5	8.0	—	0.2	15	2	1	—	—	—	—	—	—	—	—	○	—	—	—	
SNCQ 15-489001	7.94	15.875	15.875	5.5	10.0	—	0.2	15	2	1	—	—	—	—	—	—	—	—	●	—	—	—	
SNEQ 15-2063000	7.94	15.875	15.875	5.5	10.0	0.5	—	—	2	1	—	—	—	—	—	—	—	—	—	—	○	—	
SNCQ 15-489004	7.94	15.875	15.875	5.5	11.9	—	0.2	15	2	1	—	—	—	—	—	—	—	—	●	—	—	—	
SNCQ 15-489003	7.94	15.875	15.875	5.5	14.0	—	0.2	15	2	1	—	—	—	—	—	—	—	—	○	—	—	—	
S-SNCQ 15-489003	7.94	15.875	15.875	5.5	14.0	—	0.2	15	2	1	—	—	—	—	—	—	—	—	—	—	○	—	
SNCQ 15-489005	7.94	15.875	15.875	5.5	16.0	—	0.2	15	2	1	—	—	—	—	—	—	—	—	○	—	—	—	
S-SNCQ 15-489005	7.94	15.875	15.875	5.5	16.0	—	0.2	15	2	1	—	—	—	—	—	—	—	—	—	—	○	—	
S-SNCQ 15-000462	7.94	15.875	15.875	5.5	22.0	—	0.2	15	2	1	—	—	—	—	—	—	—	—	○	—	○	—	
SNCQ 15-489002	7.94	15.875	15.875	5.5	40.0	—	0.2	15	2	1	—	—	—	●	—	—	—	—	●	—	○	—	
S-SNEX 15-001873	7.94	15.875	15.875	5.8	40.0	—	0.2	15	2	1	—	—	—	—	—	—	—	—	○	—	—	—	

(S-)XOEX 12

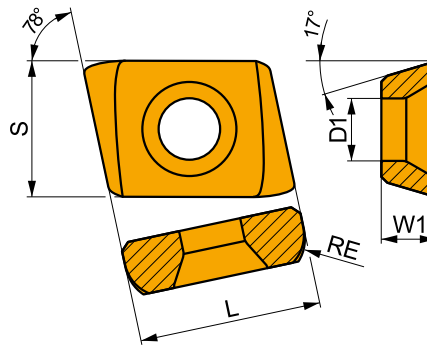

Product	W1	L	S	D1	RE	CEDC	NSIDE	7310	8215	M8310	M8325	M8326	M8330	M8340	M8345	M8346	M9315	M9325	M9340	
								(mm)	(mm)	(mm)	(mm)	(mm)								
S-XOEX 12-000013	3.8	12.7	9.450	4.4	2.8	2	1	—	—	—	—	—	—	—	—	○	—	—	—	—
XOEX 12-2355000	3.8	12.7	9.525	4.4	0.8	2	1	—	—	—	—	—	—	—	—	—	—	—	—	—

(S-)LDEX 12; 13 (CEMR)

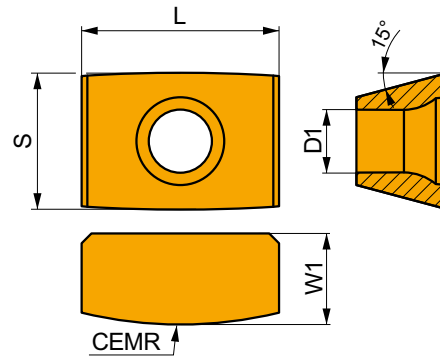

Product	W1 (mm)	L (mm)	S (mm)	D1 (mm)	CEMR (mm)	CEDC	NSIDE	7310	8215	M8310	M8325	M8326	M8330	M8340	M8345	M8346	M9315	M9325	M9340	
S-LDEX 12-1780000	3.97	12.7	7.940	3.4	-	2	1	-	-	-	-	-	-	●	-	-	-	-	-	-
LDEX 12-2102000	6.35	11.7	9.525	4.4	26.0	2	1	-	-	-	-	-	-	-	-	-	-	-	-	-
S-LDEX 12-1566000	6.35	11.7	9.525	4.4	28.0	2	1	-	-	-	-	●	-	-	-	-	-	-	-	-
S-LDEX 12-001056	4.76	12.7	9.525	4.4	15.5	2	1	-	-	-	-	-	-	-	-	-	-	-	-	-
LDEX 13-1225000	6.35	13.8	9.525	4.4	32.0	2	1	-	○	-	-	●	-	-	-	-	-	-	-	-

S-CDEW 11/(S-)XDE. 12 – 16

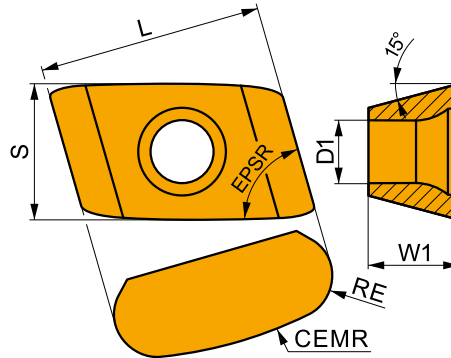

Product	W1 (mm)	L (mm)	S (mm)	D1 (mm)	RE (mm)	CEMR (mm)	EPSR (°)	CEDC	NSIDE	7310	8215	M8310	M8325	M8326	M8330	M8340	M8345	M8346	M9315	M9325	M9340
S-CDEW 11-001712	4.76	10.5	9.525	4.4	0.40	32.0	80	2	1	-	-	-	-	○	-	-	-	-	-	-	-
S-XDEW 12-001713	4.76	12.0	9.525	4.4	3.20	-	70	2	1	-	-	-	-	○	-	-	-	-	-	-	-
S-XDEX 14-1564000	6.35	14.0	9.525	4.4	3.15	26.8	74	2	1	-	-	-	-	●	-	-	-	-	-	-	-
S-XDEX 14L-1565000	6.35	14.0	9.525	4.4	3.15	26.8	74	2	1	-	-	-	-	●	-	-	-	-	-	-	-
XDEX 16-1223000	6.35	15.7	9.525	4.4	3.15	30.6	74	2	1	-	○	-	-	●	-	-	-	-	-	-	-



(S-)SN.. 12; 16 (CEMR)

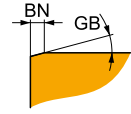
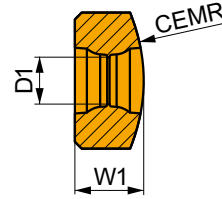
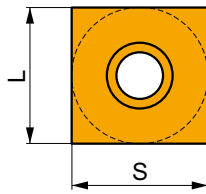

Product	W1	L	S	D1	CEMR	BN	GB	CEDC	NSIDE	7310	8215	M8310	M8325	M8326	M8330	M8340	M8345	M8346	M9315	M9325	M9340
										(mm)	(mm)	(mm)	(mm)	(mm)	(mm)	(°)					
SNQ 12-2500051	6.35	12.700	12.700	4.4	13.0	—	—	2	1	—	○	—	—	—	—	—	—	○	—	—	—
SNQ 12-488001	6.35	12.700	12.700	4.4	20.0	0.20	15	2	1	—	—	—	●	—	—	—	—	—	—	○	—
S-SNQ 12-488001	6.35	12.700	12.700	4.4	20.0	0.20	15	2	1	—	—	—	—	—	—	—	—	○	—	—	—
SNQ 12-488002	6.35	12.700	12.700	4.4	80.0	0.20	15	2	1	—	—	—	—	—	—	—	—	—	—	—	—
SNQ 12-488003	6.35	12.700	12.700	4.4	150.0	0.20	15	2	1	—	—	—	—	—	—	—	—	—	—	—	—
SNXX 12-1602003	7.94	12.700	12.700	5.5	7.0	—	—	2	1	—	—	—	—	—	—	—	—	—	—	○	—
SNXX 12-1602008	7.94	12.700	12.700	5.5	10.0	—	—	2	1	—	—	—	—	—	—	—	—	—	—	○	—
SNXX 12-1602009	7.94	12.700	12.700	5.5	12.0	—	—	2	1	—	—	—	—	—	—	—	—	—	—	○	—
SNXX 12-1602000	7.94	12.700	12.700	5.5	13.0	—	—	2	1	—	—	—	—	—	—	—	—	—	—	○	—
S-SNXX 12-1602000	7.94	12.700	12.700	5.5	13.0	—	—	2	1	—	—	—	—	—	—	—	—	○	—	—	—
S-SNXX 12-000086	7.94	12.700	12.700	5.5	14.0	—	—	2	1	—	—	—	—	—	—	—	—	—	—	○	—
SNXX 12-1602001	7.94	12.700	12.700	5.5	15.0	—	—	2	1	—	—	—	—	—	—	—	—	—	—	○	—
SNXX 12-1602005	7.94	12.700	12.700	5.5	20.0	—	—	2	1	—	—	—	—	—	—	—	—	—	—	○	—
S-SNXX 12-1602005	7.94	12.700	12.700	5.5	20.0	—	—	2	1	—	—	—	—	—	—	—	—	○	—	—	—
SNXX 12-1602004	7.94	12.700	12.700	5.5	23.0	—	—	2	1	—	—	—	—	—	—	—	—	—	—	○	—
SNXX 12-1602002	7.94	12.700	12.700	5.5	25.0	—	—	2	1	—	—	—	—	—	—	—	—	—	—	○	—
SNXX 12-1602007	7.94	12.700	12.700	5.5	35.0	—	—	2	1	—	—	—	—	—	—	—	—	—	—	○	—
SNXX 12-1602006	7.94	12.700	12.700	5.5	40.0	—	—	2	1	—	—	—	—	—	—	—	—	—	—	○	—
S-SNEQ 15-001868	6.35	15.875	15.875	5.5	55.0	0.25	15	2	1	—	—	—	—	—	—	—	—	○	—	—	—
SNGX 16-1667000	7.92	15.875	15.875	5.5	15.0	—	—	2	1	—	—	—	—	—	—	—	—	○	—	●	—
S-SNGX 16-1667000	7.92	15.875	15.875	5.5	15.0	—	—	2	1	—	—	—	—	—	○	—	—	—	—	—	—
SNGX 16-1667002	7.92	15.875	15.875	5.5	20.0	—	—	2	1	—	—	—	—	—	—	—	—	—	—	—	—
SNGX 16-1667001	7.92	15.875	15.875	5.5	25.0	—	—	2	1	—	—	—	—	—	—	—	—	●	—	—	—
S-SNEQ 15-000418	7.94	15.875	15.875	5.5	12.3	0.20	11	2	1	—	—	—	—	—	—	—	—	●	—	—	—
SNEQ 15-2500185	7.94	15.875	15.875	5.5	13.0	0.25	15	2	1	—	—	—	—	—	—	—	—	○	—	—	—
SNEQ 15-2501218	7.94	15.875	15.875	5.5	16.0	0.20	10	2	1	—	—	—	—	—	—	—	—	—	—	—	—
S-SNEQ 15-000454	7.94	15.875	15.875	5.5	18.0	0.25	15	2	1	—	—	—	—	—	—	—	—	○	—	○	—
SNEQ 15-2501219	7.94	15.875	15.875	5.5	20.0	0.20	10	2	1	—	—	—	—	—	—	—	—	○	—	○	—
SNEQ 15-2501220	7.94	15.875	15.875	5.5	22.0	0.20	10	2	1	—	—	—	—	—	—	—	—	—	—	○	—

● stocked ○ non-stocked — upon request



SNXN 13

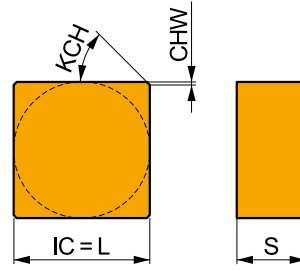

Product	IC	S	CHW	KCH	CEDC	NSIDE	7310	8215	M8310	M8325	M8326	M8330	M8340	M8345	M8346	M9315	M9325	M9340
	(mm)	(mm)	(mm)	(°)														
SNXN 13-2500361	12.975	6	0.05	45	8	2	—	—	—	—	—	—	—	—	—	○	—	—

SNEX 13; 15 (CEMR)

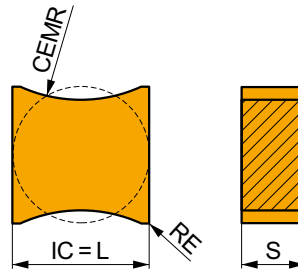

Product	IC	S	CEMR	RE	CEDC	NSIDE	7310	8215	M8310	M8325	M8326	M8330	M8340	M8345	M8346	M9315	M9325	M9340
	(mm)	(mm)	(mm)	(mm)														
SNEX 13-2501077	12.970	6	18.00	0.2	4	2	—	—	—	—	—	—	—	—	—	○	—	—
SNEX 13-2501591	12.970	6	19.33	0.2	4	2	—	—	—	—	—	—	—	—	—	○	—	—
SNEX 13-2501078	12.970	6	62.00	0.2	4	2	—	—	—	—	—	—	—	—	—	○	—	—
SNEX 15-2500362	14.975	7	16.50	0.2	4	2	—	—	—	—	—	—	—	—	—	—	—	—
SNEX 15-2500363	14.975	7	18.98	0.2	4	2	—	—	—	—	—	—	—	—	—	—	—	—
SNEX 15-2500364	14.975	7	60.00	0.2	4	2	—	—	—	—	—	—	—	—	—	—	—	—



(S-)SNEX 13 – 27

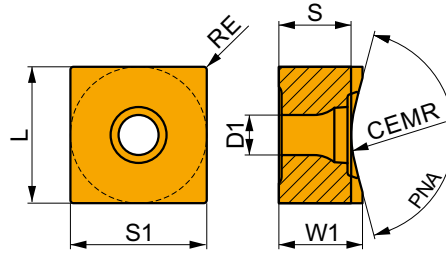

Product	W1	L	S	S1	D1	CEMR	RE	PNA	CEDC	NSIDE	7310	8215	M8310	M8325	M8326	M8330	M8340	M8345	M8346	M9315	M9325	M9340	
											(mm)	(mm)	(mm)	(mm)	(mm)	(mm)	(mm)	(°)					
SNEX 13-2375000	6.350	13.500	6.220	13.500	4.40	150.000	0.4	-	4	1	-	-	-	-	-	-	-	-	-	-	-	-	-
SNEX 14-2386000	7.220	13.500	6.220	13.500	4.40	10.000	-	144.0	4	1	-	-	-	-	-	-	-	-	-	-	-	-	-
SNEX 14-2157000	7.220	13.500	6.290	13.500	4.40	16.500	-	154.0	4	1	-	-	o	-	-	-	-	-	-	-	-	-	-
SNEX 14-2190000	7.220	13.500	6.536	13.500	4.40	18.500	-	161.4	4	1	-	-	-	-	-	-	-	-	-	-	-	-	-
SNEX 14-2396000	8.000	13.500	7.300	13.500	5.50	16.500	0.4	160.0	4	1	-	-	-	-	-	-	-	-	-	-	-	-	-
S-SNEX 14-000979	8.000	13.500	7.318	13.500	5.50	18.650	0.4	160.7	4	1	o	-	-	-	-	-	-	-	-	-	-	-	-
S-SNEX 14-000909	8.570	14.500	7.700	14.500	5.60	19.800	0.4	155.67	4	1	o	-	-	-	-	-	-	-	-	-	-	-	-
SNEX 15-2500522	7.940	15.000	7.940	15.000	4.40	20.600	0.4	-	4	1	-	-	●	-	-	-	-	-	-	-	-	-	-
SNEX 15-2501820-R 80	8.100	15.000	7.910	15.000	4.40	83.000	0.4	175.0	4	1	-	-	-	-	-	-	-	-	-	-	-	-	-
SNEX 15-2500015	8.170	15.000	7.900	15.000	4.40	100.000	0.4	-	4	1	-	-	-	-	-	-	-	-	-	-	-	-	-
S-SNEX 15-2500169	8.280	15.000	8.280	15.000	4.40	27.800	0.4	-	4	1	●	-	-	-	-	-	-	-	-	-	-	-	-
SNEX 15-2501819-R 13	8.400	15.000	7.500	15.000	4.40	13.000	0.4	150.0	4	1	-	-	-	-	-	-	-	-	-	-	-	-	-
SNEX 15-2500014	9.130	15.000	7.937	15.000	4.40	23.500	0.4	-	4	1	-	-	-	-	-	-	-	-	-	-	-	-	-
S-SNEX 15-000953	9.140	15.000	7.940	15.000	4.40	18.000	0.4	155.0	4	1	o	-	-	-	-	-	-	-	-	-	-	-	-
SNEX 15-2500013	9.140	15.000	8.218	15.000	4.40	30.000	0.4	-	4	1	-	-	-	-	-	-	-	-	-	-	-	-	-
S-SNEX 15-000032	9.200	15.000	7.940	15.000	4.40	12.000	0.4	148.0	4	1	o	-	-	-	-	-	-	-	o	-	-	-	-
S-SNEX 15-000706	9.200	15.000	7.940	15.000	4.40	12.000	0.4	150.0	4	1	o	-	-	-	-	-	-	-	-	-	-	-	-
SNEX 15-2301000	5.790	15.875	5.450	15.875	4.40	90.000	0.4	-	4	1	-	-	-	-	-	-	-	-	-	-	-	-	-
SNEX 15-2425000	5.820	15.875	5.400	15.875	4.40	50.000	0.4	172.0	4	1	-	-	o	-	-	-	-	-	-	-	-	-	-
SNEX 15-2322000	5.870	15.875	5.485	15.875	4.40	80.000	0.4	-	4	1	-	-	-	-	-	-	-	-	-	-	-	-	-
SNEX 15-2318000	5.950	15.875	5.560	15.875	4.40	79.000	0.4	-	4	1	-	-	-	-	-	-	-	-	-	-	-	-	-
SNEX 15-2302000	5.960	15.875	5.580	15.875	4.40	80.000	0.4	-	4	1	-	-	-	-	-	-	-	-	-	-	-	-	-
SNEX 15-2224000	6.000	15.875	4.410	15.875	4.40	16.000	0.4	144.0	4	1	-	-	-	-	-	-	-	-	-	-	-	-	-
SNEX 15-2427000	6.070	15.875	4.910	15.875	4.40	16.000	0.4	159.4	4	1	-	-	o	-	-	-	-	-	-	-	-	-	-
SNEX 15-2426000	6.250	15.875	5.200	15.875	4.40	25.000	0.4	158.0	4	1	-	-	o	-	-	-	-	-	-	-	-	-	-
SNEX 15-2321000	6.350	15.875	5.050	15.875	4.40	12.000	0.4	154.0	4	1	-	-	o	-	-	-	-	-	-	-	-	-	-
SNCQ 15-2500317	6.350	15.875	5.330	15.875	5.50	13.000	0.8	-	4	1	-	-	-	-	-	-	-	-	-	-	-	-	-
S-SNEX 15-001870	6.350	15.875	5.330	15.875	5.60	13.000	0.8	-	4	1	-	-	-	-	-	-	-	-	o	-	-	-	-
SNEX 15-2225000	6.350	15.875	5.380	15.875	4.40	18.750	0.4	154.0	4	1	-	-	-	-	-	-	-	-	-	-	-	-	-
SNEX 15-2323000	6.350	15.875	5.200	15.875	4.40	20.000	0.4	158.0	4	1	-	o	-	-	-	-	-	-	-	-	-	-	-
SNCQ 15-2500318	6.350	15.875	6.200	15.875	5.50	80.000	0.8	-	4	1	-	-	-	-	-	-	-	-	-	-	-	-	-
S-SNEX 15-001871	6.350	15.875	6.200	15.875	5.60	80.000	0.8	-	4	1	-	-	-	-	-	-	-	-	o	-	-	-	-
SNEX 15-2500950	7.495	15.875	7.100	15.875	5.50	80.000	-	-	4	1	-	-	-	-	-	-	-	-	o	-	-	-	-
S-SNEX 15-001849	7.940	15.875	6.300	15.875	5.50	6.000	-	120.0	4	1	-	-	-	-	-	-	-	-	-	-	●	-	-
SNEX 15-2000000	7.940	15.875	5.350	15.875	4.90	8.475	-	-	4	1	-	-	-	o	-	-	-	-	-	-	-	-	-
SNEX 15-2000002	7.940	15.875	6.940	15.875	4.90	15.000	-	-	4	1	-	-	-	-	-	-	-	-	-	-	-	-	-
SNEX 15-2455000	7.940	15.875	6.300	15.875	4.90	15.000	-	140.0	4	1	-	-	-	-	-	-	-	-	-	-	-	-	-
SNEX 15-2424000	7.940	15.875	7.030	15.875	5.50	15.700	-	159.5	4	1	-	-	-	-	-	-	-	-	o	-	-	-	-
S-SNEX 15-2424000	7.940	15.875	7.030	15.875	5.50	15.700	-	159.5	4	1	o	-	-	-	-	-	-	-	-	-	-	-	-
SNEX 15-2000003	7.940	15.875	7.440	15.875	4.90	35.000	-	-	4	1	-	-	-	-	-	-	-	-	o	-	-	-	-
SNEX 27-1900000	13.30	27.000	8.520	27.000	9.12	15.000	0.8	124.0	4	1	-	-	-	-	-	-	-	-	-	-	-	-	-



(S)SP.X 12 – 27

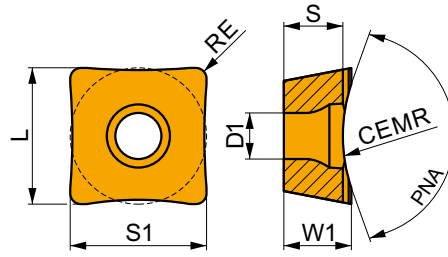

Product	W1 (mm)	L (mm)	S (mm)	S1 (mm)	D1 (mm)	CEMR (mm)	RE (mm)	PNA (°)	CEDC	NSIDE	7310	8215	M8310	M8325	M8326	M8330	M8340	M8345	M8346	M9315	M9325	M9340	
SPEX 12-2003004	6.35	12.700	–	12.700	4.40	0.00	0.8	–	4	1	–	–	○	–	–	–	–	–	–	–	–	–	○
SPEX 12-2003001	6.35	12.700	4.91	12.700	4.40	2.00	0.8	110.0	4	1	–	–	–	–	–	–	–	–	–	–	–	–	–
SPEX 12-2003002	6.35	12.700	5.13	12.700	4.40	3.00	0.8	110.0	4	1	–	–	–	○	–	–	–	–	–	–	–	–	–
SPEX 12-1646000	6.35	12.700	5.35	12.700	4.40	4.00	0.8	134.0	4	1	–	–	–	–	–	–	–	–	–	–	–	–	–
SPEX 12-2003000	6.35	12.700	5.35	12.700	4.40	4.00	0.8	110.0	4	1	–	–	–	–	–	–	–	–	–	–	–	–	–
SPEX 12-2003012	6.35	12.700	5.19	12.700	4.40	5.00	0.8	120.0	4	1	–	–	–	–	–	–	–	–	–	–	–	–	–
S-SPEX 12-1646001	6.35	12.700	5.35	12.700	4.40	5.00	0.8	134.0	4	1	–	–	–	–	–	–	○	–	○	–	–	–	–
SPEX 12-2003011	6.35	12.700	4.85	12.700	4.40	6.00	0.8	130.0	4	1	–	–	–	–	–	–	–	–	–	–	–	–	–
SPEX 12-1646003	6.35	12.700	5.35	12.700	4.40	6.50	0.8	140.0	4	1	–	–	–	–	–	–	–	–	–	–	–	–	–
S-SPEX 12-1646002	6.35	12.700	5.35	12.700	4.40	8.00	0.8	134.0	4	1	–	–	–	–	–	–	–	–	○	–	–	–	–
SPEX 12-2003006	6.35	12.700	5.05	12.700	4.40	10.00	0.8	134.7	4	1	–	–	–	–	–	–	–	–	–	–	–	○	–
SPEX 12-2003007	6.35	12.700	5.45	12.700	4.40	13.00	0.8	143.0	4	1	–	–	–	–	–	–	–	–	–	●	–	–	–
SPEX 12-2003005	6.35	12.700	5.55	12.700	4.40	15.00	0.8	149.5	4	1	–	–	–	–	–	–	–	–	–	–	–	–	–
SPEX 12-2003008	6.35	12.700	6.20	12.700	4.40	80.00	0.8	–	4	1	–	–	–	–	–	–	–	–	○	–	–	–	–
SPEX 12-2003003	7.25	13.050	5.75	13.050	4.40	5.00	0.8	100.0	4	1	–	–	–	–	–	–	–	–	–	–	–	–	–
SPEX 12-2003009	7.25	13.050	5.65	13.050	4.40	5.00	0.8	140.0	4	1	–	–	–	–	–	–	–	–	–	–	–	–	–
SPEX 15-1522001	7.94	15.875	7.24	15.875	5.50	30.00	0.8	158.0	4	1	–	–	–	–	–	–	–	–	–	–	–	–	–
SPEX 15-1522002	7.94	15.875	7.50	15.875	5.50	40.00	0.8	–	4	1	–	–	–	–	–	–	–	–	–	–	–	–	–
SPEX 15-1522003	7.94	15.875	7.74	15.875	5.50	80.00	0.8	–	4	1	–	–	–	–	–	–	–	–	–	–	–	–	–
SPGX 19-2280000	8.60	19.000	6.35	19.000	6.70	15.78	0.4	131.0	4	1	–	–	–	–	–	–	–	–	–	–	–	–	–
S-SPGX 19-000968	8.60	19.000	6.60	19.000	6.70	17.00	1.0	131.0	4	1	○	–	–	–	–	–	–	–	–	–	–	–	–
SPEX 27-2161000	13.30	27.085	8.45	27.085	9.12	15.00	0.8	124.0	4	1	–	–	–	–	–	–	–	–	–	–	–	–	–



(S-)SN.Q 15

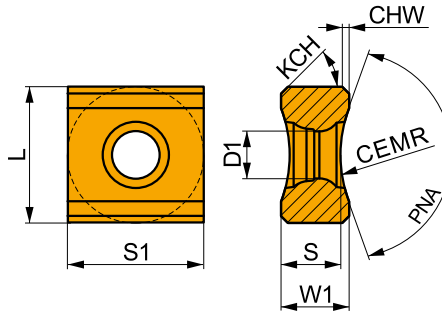

Product	W1	L	S	S1	D1	CEMR	PNA	CHW	KCH	CEDC	NSIDE	7310	8215	M8310	M8325	M8326	M8330	M8340	M8345	M8346	M9315	M9325	M9340	
	(mm)	(mm)	(mm)	(mm)	(mm)	(mm)	(°)	(mm)	(°)															
S-SNEQ 15-001652	7.94	15.875	6.90	15.875	5.5	8.00	140	0.5	45	4	2	—	—	—	—	—	—	—	—	—	○	—	—	—
S-SNCQ 15-510001	7.94	15.875	6.94	15.875	5.5	10.00	—	—	—	4	2	—	—	—	—	—	—	—	—	—	○	—	○	—
SNEQ 15-2064001	7.94	15.875	6.94	15.875	5.5	12.70	—	0.5	45	4	2	—	—	—	—	—	—	—	—	—	—	—	—	—
SNCQ 15-1806000	7.94	15.875	6.56	15.875	5.5	13.00	141	—	—	4	2	—	—	—	—	—	—	—	—	—	—	—	—	—
SNCQ 15-510002	7.94	15.875	6.94	15.875	5.5	13.00	—	—	—	4	2	—	—	—	●	—	—	—	—	—	—	○	—	—
S-SNEQ 15-2064000	7.94	15.875	7.19	15.875	5.5	15.00	—	0.5	45	4	2	—	—	—	—	—	—	—	—	—	○	—	—	—
SNCQ 15-510003	7.94	15.875	6.94	15.875	5.5	15.25	—	—	—	4	2	—	—	—	—	—	—	—	—	—	○	—	—	—
S-SNCQ 15-510003	7.94	15.875	6.94	15.875	5.5	15.25	—	—	—	4	2	—	—	—	—	—	—	—	—	—	—	○	—	—
S-SNCQ 15-000484	7.94	15.875	7.70	15.875	5.5	80.00	—	—	—	4	2	—	—	—	—	—	—	—	—	—	○	—	○	—

S-LNEX 15

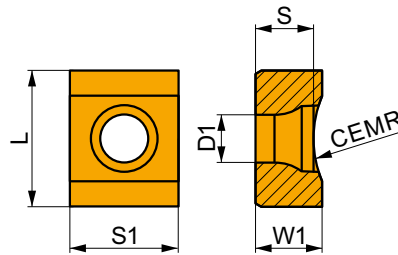
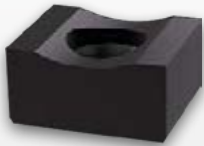

Product	W1	L	S	S1	D1	CEMR	CEDC	NSIDE	7310	8215	M8310	M8325	M8326	M8330	M8340	M8345	M8346	M9315	M9325	M9340			
	(mm)	(mm)	(mm)	(mm)	(mm)	(mm)																	
S-LNEX 15-001853	7.8	15.875	6.8	12.7	5.65	13	2	1	—	—	—	—	—	—	—	—	—	○	—	—	—	—	—
S-LNEX 15-001854	7.8	15.875	7.6	12.7	5.65	80	2	1	—	—	—	—	—	—	—	—	—	○	—	—	—	—	—



(S-)LPGX 27

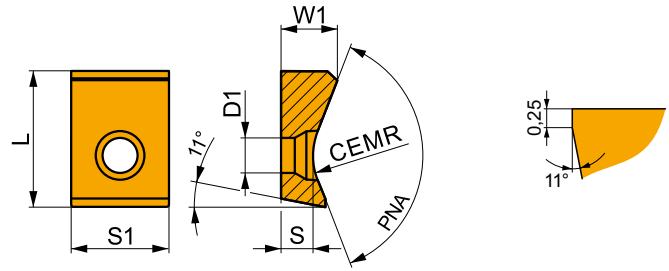

Product	W1 (mm)	L (mm)	S (mm)	S1 (mm)	D1 (mm)	CEMR (mm)	PNA (°)	CEDC	NSIDE	7310	8215	M8310	M8325	M8326	M8330	M8340	M8345	M8346	M9315	M9325	M9340	
										—	○	—	—	—	—	—	—	—	—	—	—	—
LPGX 27-2351000	11.22	25.36	6.35	18.953	6.7	13.2	135.50	2	1	—	—	—	—	—	—	—	—	—	—	—	—	—
S-LPGX 27-1903000	10.91	26.337	6.35	18.953	6.7	15.5	135.00	2	1	○	—	—	—	—	—	—	—	—	—	—	—	—
LPGX 27-2501570	11.28	26.337	6.35	18.953	6.7	16.4	129.15	2	1	—	—	○	—	—	—	—	—	—	—	—	—	—

(S-)SP.W 14 – 19

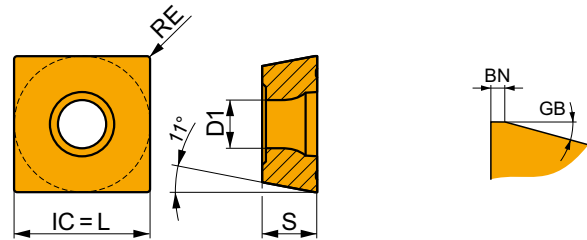

Product	IC (mm)	S (mm)	D1 (mm)	RE (mm)	BN (mm)	GB (°)	CEDC	NSIDE	7310	8215	M8310	M8325	M8326	M8330	M8340	M8345	M8346	M9315	M9325	M9340		
									—	○	—	—	—	—	—	—	—	—	—	—	—	—
SPEW 14-2162000	14.280	6.35	4.4	0.0	—	—	4	1	—	—	—	—	—	—	—	—	—	—	—	—	—	—
S-SPGW 15-1906000	15.875	6.35	5.5	0.5	0.25	0	4	1	○	—	—	—	—	—	—	—	—	—	—	—	—	—
SPGW 15-2500368	15.875	6.35	5.5	0.8	0.20	0	4	1	—	—	—	—	—	—	—	—	—	—	—	—	—	—
SPMW 19-1904000	19.050	6.35	6.6	0.4	0.15	15	4	1	—	—	—	—	—	—	—	—	—	—	—	—	—	—
S-SPGW 19-1905000	19.050	6.35	6.6	0.1	0.15	15	4	1	—	—	—	—	—	—	—	—	—	—	—	—	—	○



S-SPEN 12

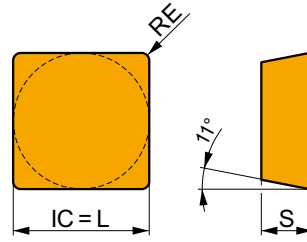

Product	IC	S	RE	CEDC	NSIDE	7310	8215	M8310	M8325	M8326	M8330	M8340	M8345	M8346	M9315	M9325	M9340	
	(mm)	(mm)	(mm)			(mm)												
S-SPEN 120408	12.7	4.76	0.8	4	1	—	●	○	—	—	—	—	—	—	—	—	—	—

S-SPEN 12; 15

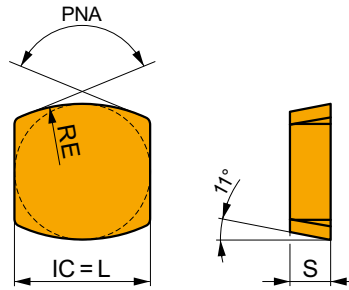

Product	IC	S	RE	PNA	CEDC	NSIDE	7310	8215	M8310	M8325	M8326	M8330	M8340	M8345	M8346	M9315	M9325	M9340	
	(mm)	(mm)	(mm)	(°)															
S-SPEN 12-000987	12.700	4.76	20.00	150	2	1	—	○	—	—	—	—	—	—	—	—	—	—	—
S-SPEN 15-000780	15.875	4.76	7.00	112	2	1	—	○	—	—	—	—	—	—	—	—	—	—	—
S-SPEN 15-000859	15.875	4.76	8.00	—	4	1	—	○	—	—	—	—	—	—	—	—	—	—	—
S-SPEN 15-000988	15.875	4.76	11.50	100	2	1	—	○	—	—	—	—	—	—	—	—	—	—	—
S-SPEN 15-001205	15.875	4.76	12.70	—	2	1	—	○	—	—	—	—	—	—	—	—	—	—	—
S-SPEN 15-000856	15.875	4.76	16.00	—	2	1	—	○	—	—	—	—	—	—	—	—	—	—	—
S-SPEN 15-000595	15.875	4.76	18.00	132	2	1	—	○	—	—	—	—	—	—	—	—	—	—	—
S-SPEN 15-001108	15.875	4.76	19.05	—	2	1	—	○	—	—	—	—	—	—	—	—	—	—	—
S-SPEN 15-000857	15.875	4.76	22.00	—	2	1	—	○	—	—	—	—	—	—	—	—	—	—	—



S-RPGN 20

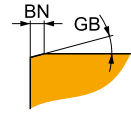
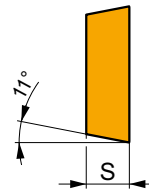
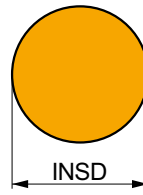

Product	INSD	S	BN	GB	NSIDE	7310	8215	M8310	M8325	M8326	M8330	M8340	M8345	M8346	M9315	M9325	M9340
	(mm)	(mm)	(mm)	(°)													
S-RPGN 20-000606	20	6.35	0.17	10	1	—	○	—	—	—	—	—	—	—	—	—	—

(S-)LC 16 – 32

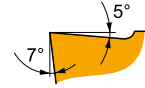
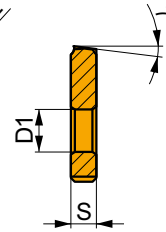
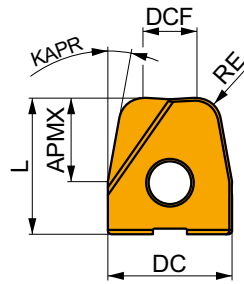

LC16, LC20

Product	DC	L	S	D1	RE	APMX	DCF	KAPR	CEDC	NSIDE	7310	8215	M8310	M8325	M8326	M8330	M8340	M8345	M8346	M9315	M9325	M9340	
	(mm)	(mm)	(mm)	(mm)	(mm)	(mm)	(mm)	(°)															
LC 16-2381000-R3	15	16	3	5	3.00	9.9	11.5	1:6	2	2	—	—	—	—	—	—	—	—	—	—	—	—	—
LC 20-2382000-R3	20	18	3	5	3.00	16.0	16.0	1:6	2	2	—	—	—	—	—	—	—	—	—	—	—	—	—
S-LC 32-001510	32	28	5	8	0.25	12.5	9.5	47	2	2	—	—	—	—	—	—	—	—	—	—	—	—	—



(S-)LC 32

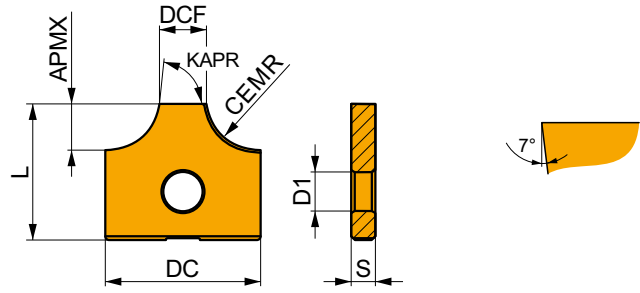

Product	DC (mm)	L (mm)	S (mm)	D1 (mm)	CEMR (mm)	APMX (mm)	DCF (mm)	KAPR (°)	CEDC	NSIDE	7310	8215	M8310	M8325	M8326	M8330	M8340	M8345	M8346	M9315	M9325	M9340	
											—	—	—	—	—	—	—	—	—	—	—	—	—
S-LC 32 R6-000424	32	28	5	8	6.04	6.06	17.83	80	2	2	—	—	—	—	—	—	—	—	—	—	—	—	—
LC 32-2383000-R6	32	28	5	8	6.25	4.36	18.24	62	2	2	—	—	—	—	—	—	—	—	—	—	—	—	—
LC 32-2385000-R10	32	28	5	8	10.50	9.49	10.89	78	2	2	—	—	—	—	—	—	—	—	—	—	—	—	—
LC 32-2384000-R13	32	28	5	8	14.40	11.95	6.96	75	2	2	—	—	—	—	—	—	—	—	—	—	—	—	—

RNGX 12

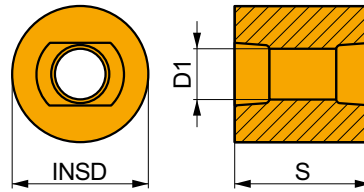

Product	INSD (mm)	S (mm)	D1 (mm)	NSIDE	S30	7330
					—	—
RNGX 1212MO	12.000	12.000	4.4	2	—	—



ROEX 15

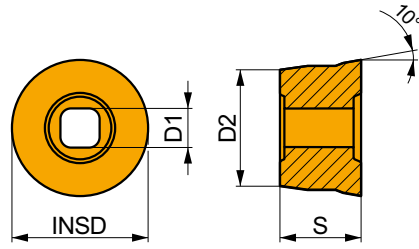

Product	INSD	S	D1	D2	NSIDE	S30	7330
	(mm)	(mm)	(mm)	(mm)			
ROEX 1509MOEN	15.9	9.525	4.6	14.65	1	●	—
ROEX 15-2501908	15.9	9.525	4.6	14.65	1	—	○

S-RNEX 15

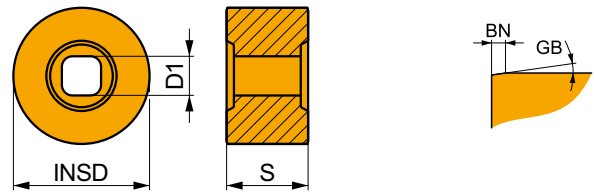
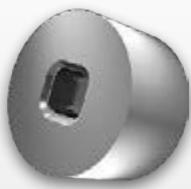

Product	INSD	S	D1	BN	GB	NSIDE	HF10	S30
	(mm)	(mm)	(mm)	(mm)	(°)			
S-RNEX 15-001309	15.875	9.525	4.6	0.24	20°30'	2	○	○

S-RNEX 16

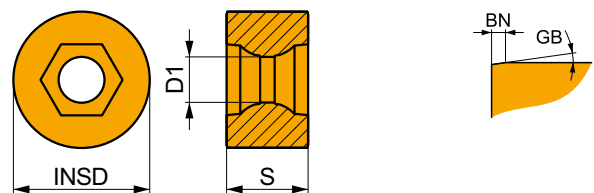

Product	INSD	S	D1	BN	GB	NSIDE	8215	S30
	(mm)	(mm)	(mm)	(mm)	(°)			
S-RNEX 16-000710	16.00	9.525	5.4	0.24	20°30'	2	○	—



RAILWAY – HOLEMAKING ASSORTMENT

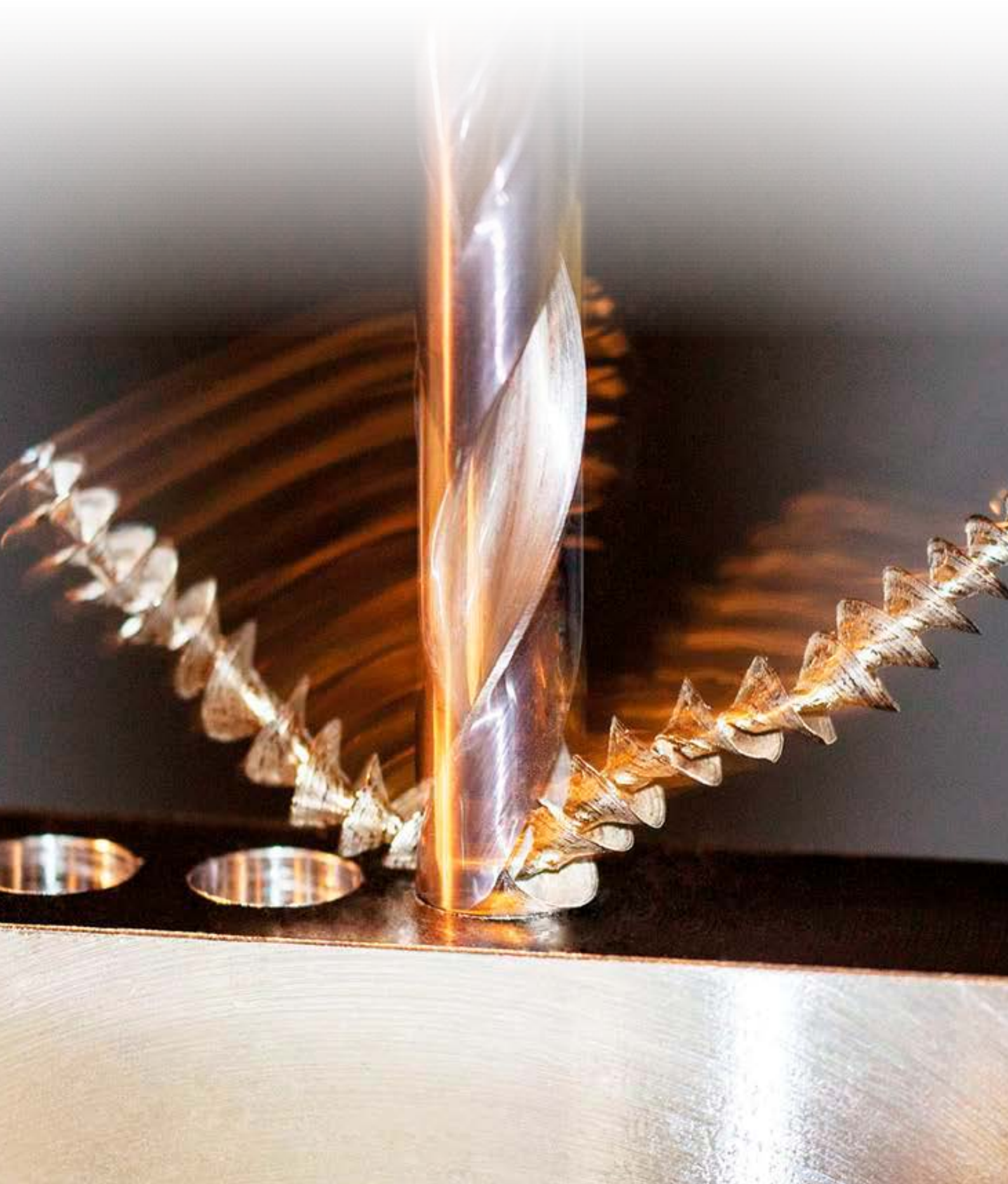

**CONTENT**

7		INTRODUCTION & ASSORTMENT HIGHLIGHTS
13	RAILWAY INDUSTRY	PRODUCTION OF NEW RAILWAY WHEELS
20		RAILWAY WHEEL RECONDITIONING
26		AXLES MACHINING
30		STATIONARY & DYNAMIC RAIL MILLING
37		TURNOUTS MACHINING
57		BASE PLATES MACHINING
63		WAGON & BOGIE PARTS MACHINING
73		TURNING ASSORTMENT
92	POSITIVE INSERTS	
129	NEGATIVE INSERTS	
248	MILLING ASSORTMENT	SOLID HM & HSS MILLS
269		ROTARY BURRS
289		INDEXABLE MILLS
433	HOLEMAKING ASSORTMENT	SOLID CARBIDE & HSS DRILLS
456		REAMERS & COUNTERSINKS
477		EXCHANGEABLE HEAD INDEXABLE DRILLS
533	THEARDING ASSORTMENT	MATERIAL SPECIFIC & HSS TAPS
548		TECHNICAL PART



CUTTING TOOL PARAMETERS ACCORDING TO ISO 13399

All cutting tools are defined by a number of parameters according to the standard ISO 13399. This list contains all the parameters used in this catalogue and their definitions.

ISO 13399 is an international cutting tool information standard. It provides dimensions and parameters in a neutral format that is independent of any particular system or company nomenclature. When cutting tools are clearly defined according to a global standard, all types of software can process the electronic data more quickly, improving the quality of communication and helping to make the exchange of

information run smoothly. By supporting a common language in our cutting tool descriptions will assist this system to system communication. It will save you significant amount of time, providing an easier gathering of high-quality data across our 40,000 solid and indexable tools. By using a ISO 13399 compliant system, there will be no need to manually interpret data and key-enter it into your system.

EXAMPLES ONLY!

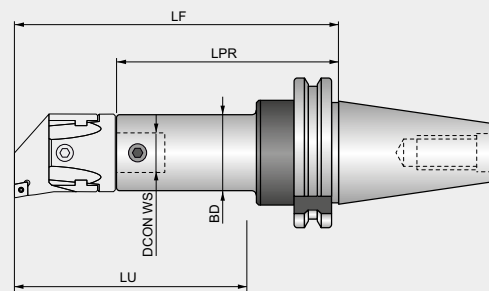
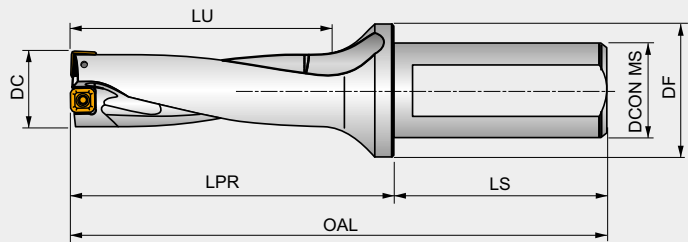
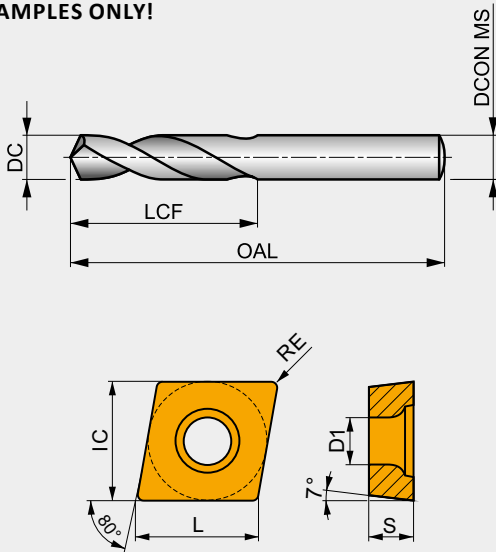

ISO 13399	description
BD	Body diameter
BDX	Body diameter maximum
CZC MS	Connection size code machine side
D1	Fixing hole diameter
DC	Cutting diameter
DCN	Cutting diameter minimum
DCON MS	Connection diameter machine side
DCON WS	Connection diameter workpiece side
DCX	Cutting diameter maximum
DHUB	Hub diameter
FLGT	Flange thickness
IC	Inscribed circle diameter
L	Cutting edge length
LB	Body length
LF	Functional length
LPR	Protruding length
LU	Usable length
OAL	Overall length
RE	Corner radius
S	Insert thickness
WF	Functional width
APMX	Depth of cut maximum
D1	Fixing hole diameter
DC_1	Cutting diameter first cutting step
DC_2	Cutting diameter second cutting step

ISO 13399	description
DF	Flange diameter
DH	Head diameter
GPD	Guide pilot diameter
GPL	Guide pilot length
H	Shank height
HSD	Size of drive part
IC	Inscribed circle diameter
LCF	Length chip flute
LCOL	Collet length
LDC	Distance reference point PK
LH	Head length
LS	Shank length
LSC	Clamping length
NOF	Number of flutes
PLGL	Plug length
RCSK	Radius countersunk
RE	Corner radius
SDI	Step diameter increments
SDL	Step diameter length
SDL_1	Step diameter length first cutting step
SDL_2	Step diameter length second cutting step
TDZ	Thread diameter size
THLGTH	Thread length
WSC	Clamping width



SOLID CARBIDE & HSS DRILLS



1 R457



Solid Carbide Jobber Drill, Bright Finish

Improved wear resistance for increased productivity and extended tool life. A 120°, 4-facet point helps with self-centering and reduces cutting forces. Can be used with all CNC machine applications.

3 FORCE X

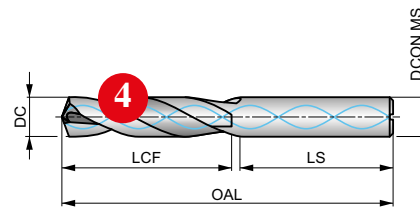

5

HM	DIN 6537K	3xD
140°	TAIN	DIN 6535HA
CTV	DC	m7

Workpiece material group suitability, starting values for cutting speed (m/min) and feed Alpha Code. Tables with feed per revolution can be found starting from page 65.

P1.1	P1.2	P1.3	P2.1	P2.2	P2.3	P3.1	P3.2	P3.3	P4.1	P4.2	P4.3	M1.1	M1.2
179 W	200 W	207 W	153 W	135 W	119 V	133 V	107 V	90 V	79 V	67 V	55 U	75 V	64 V
M2.1	M2.2	M2.3	M3.1	M3.2	M3.3	M4.1	M4.2	K1.1	K1.2	K1.3	K2.1	K2.2	K2.3
67 V	55 V	46 U	41 V	35 V	32 V	30 U	26 U	110 W	81 W	61 W	98 V	80 V	64 V
K3.1	K3.2	K3.3	K4.1	K4.2	K4.3	K4.4	K4.5	K5.1	K5.2	K5.3	N1.1	N1.2	N1.3
87 V	67 V	54 V	81 V	61 V	45 V	38 V	32 V	91 V	69 V	53 V	250 W	188 W	125 W
N2.1	N2.2	N2.3	N3.1	N3.2	N3.3	S1.1	S1.2	S1.3	H1.1	H2.1	H2.2	H3.1	H3.2
308 V	277 V	200 V	373 W	220 W	110 W	55 V	45 V	40 U	56 U	33 U	30 U	37 U	30 U

CON MS tolerance h6.

Product	DC	DC	DC	LCF	OAL	LS	DCON MS
	(inch)	(mm)	(inch)	(mm)	(mm)	(mm)	(mm)
14573.0	–	3.00	0.1181	20.0	62.0	36.0	6.00
14573.1	–	3.10	0.1220	20.0	62.0	36.0	6.00
14571/8	1/8	3.18	0.1250	20.0	62.0	36.0	6.00
14573.2	–	3.20	0.1260	20.0	62.0	36.0	6.00
1457N30	N30	3.26	0.1283	20.0	62.0	36.0	6.00
14573.3	–	3.30	0.1299	20.0	62.0	36.0	6.00
14573.4	–	3.40	0.1339	20.0	62.0	36.0	6.00
1457N29	N29	3.45	0.1360	20.0	62.0	36.0	6.00
14573.5	–	3.50	0.1378	20.0	62.0	36.0	6.00
1457N28	N28	3.57	0.1406	20.0	62.0	36.0	6.00

Pos.	Description
1	Designation of drill
2	Product description
3	Illustrative picture
4	Schematic drawing of tool

Pos.	Description
5	Product features
6	Material group recommendations incl. speed and feed guidance
7	Product code
8	Product dimensions



SOLID CARBIDE & HSS DRILLS – ICONS OVERVIEW

GENERAL ICONS

	Primary use		Possible use
--	-------------	--	--------------

APPLICATION ANGLE

	60° Countersink Centre Drill		Radius Countersink Centre Drill		Pre-Drill with 90° Chamfer (for tapping)
	Drill Point 118°		Spot Drill Point 90°/120°		Spot Drill Point 150°
	Drill Point 120°		Spot-weld Drill Point 180°		Spot Drill Point 90°
	Drill Point 122°		Step-drill (for fasteners) 180° Counterbore		Spot Drill Point 120°
	Drill Point 130°		Step-drill (for fasteners) 90° Counterbore		
	Drill Point 135°		Drill Point 140°		

BASIC STANDARD GROUP (BSG)

	BS 328 – Drills and Reamers Standards		DIN 1899 – Micro Drill Standards		DIN 8037 – Carbide Tipped Drill Standards
	DIN 1869 / 1 – Straight Shank Extra Long Drill Standards		DIN 333A – Centre Drill Standards		DIN 8374 – Subland Drill Standards
	DIN 1869 / 2 – Straight Shank Extra Long Drill Standards		DIN 333R – Straight Shank Countersink Standards		DIN 8376 – Step Drill Standards
	DIN 1869 / 3 – Straight Shank Extra Long Drill Standards		DIN 338 – Straight Shank Drill Standards		DIN 8377 – Subland Drill Standards
	DIN 1870 (1) – Morse Taper Shank Extra Long Drill Standards		DIN 340 – Taper Length Drill Standards		DIN/ANSI Standards
	DIN 1870 (2) – Morse Taper Shank Extra Long Drill Standards		DIN 341 – Morse Taper Shank Long Drill Standards		Dormer Standards
	DIN 1897 – Stub Drill Standards		DIN 345 – Morse Taper Shank Drill Standards		NAS907 – Aerospace Drill Standards

COATING

	Aluminium Chromium Nitride (with smoothing process)		Bronze Tempered (Bronze Oxide) Surface Treatment		Titanium Aluminium Nitride (with smoothing process)
	Bright (uncoated)		Combination Bright and Steam Tempered		Titanium Aluminium Nitride Coating
	Bright and TiN (Tip Coating)		Steam Tempered (Steam Oxide) Surface Treatment		Titanium Nitride Coating



SOLID CARBIDE & HSS DRILLS – ICONS OVERVIEW

COOLANT SUPPLY PROPERTY (CSP)



Through Tool Coolant

CUTTING DIRECTION



Left Hand Rotation / Cutting



Right Hand Rotation / Cutting

CUTTING DIAMETER TOLERANCE ZONE CLASS (TCDC)

DC
h8

h8 – Industry Standard Tool Tolerance Zone
(based on diameter range)

DC
h7

h7 – Industry Standard Tool Tolerance Zone
(based on diameter range)

DC
m7

m7 – Industry Standard Tool Tolerance Zone
(based on diameter range)

DC
h6

h6 – Industry Standard Tool Tolerance Zone
(based on diameter range)

MATERIAL CODE (BMC)

HM

Hard Material (Solid Carbide)

HSS
HM

High Speed Steel (tool body) with Solid Carbide
(cutting tool material)

HSS

High Speed Steel Tool Material

HSS-E

High Speed Cobalt Steel Tool Material

SHANK



Cylindrical Shank / Straight Shank



Cylindrical Shank with Tang



Morse Taper Shank



Cylindrical Shank with Flat



DIN 6535 HA Cylindrical Shank



Reduced Cylindrical Shank

SPIRAL FORM



Quick Spiral Flute Design



Standard Spiral Flute Design



Continuously Thinned Web Flute Design



Slow Spiral Flute Design



Quick Spiral Flute Design



Special Point Thinning Design

USABLE LENGTH DIAMETER RATIO (ULDR)

1.25×D

1.25×D Usable Tool Depth to Diameter Ratio

2.5×D

2.5×D Usable Tool Depth to Diameter Ratio

5×D

5×D Usable Tool Depth to Diameter Ratio

1.5×D

1.5×D Usable Tool Depth to Diameter Ratio

20×D

20×D Usable Tool Depth to Diameter Ratio

6×D

6×D Usable Tool Depth to Diameter Ratio

10×D

10×D Usable Tool Depth to Diameter Ratio

25×D

25×D Usable Tool Depth to Diameter Ratio

8×D

8×D Usable Tool Depth to Diameter Ratio

15×D

15×D Usable Tool Depth to Diameter Ratio

3×D

3×D Usable Tool Depth to Diameter Ratio

1×D

1×D Usable Tool Depth to Diameter Ratio

4×D

4×D Usable Tool Depth to Diameter Ratio



FORCE X

HIGH PERFORMANCE CARBIDE DRILLS

VERSATILE PRODUCTION DRILLS FOR A WIDE RANGE OF MATERIALS

FORCE X carbide drills are developed for high performance machining applications in a wide variety of work-materials such as Carbon and Alloy Steels up to 1500 MPa and Cast-Iron. FORCE X drills also perform well in Stainless Steel and Aluminium making them an ideal first choice for subcontract machining companies.

FEATURES AND BENEFITS

- CTW  – Unique Flute Construction with a continuously thinned web and rolled heel design.
- Modified 4-Facet Split Point with large secondary chisel edge angle.
- Premium micrograin carbide substrate with TiAlN coating.
- 3xD and 5xD options available in solid and coolant-feed variants.
- 8xD with coolant-feed.

COMPARED TO CONVENTIONAL DRILLS FORCE X ARE:

- **Outstandingly economical** – Able to be re-ground multiple times, this significantly increases total tool life.
- **Consistently high quality and performance** – with excellent positional accuracy and swarf control, ensuring a superior quality hole tolerance and surface finish.
- **More productive** – with high drilling speeds and prolonged tool-life.



RANGE DETAILS

3xD



R457

Coolant-feed

R458

Solid

- 3.00 – 20.00 mm
- 1/8 – 3/4 inch, N30 – N1, A – Z

5xD



R453

Coolant-feed

R454

Solid

- 3.00 – 20.00 mm
- 1/8 – 3/4 inch, N30 – N1, A – Z

8xD



R459

Coolant-feed

- 3.00 – 16.00 mm
- 1/8 – 5/8 inch





SOLID CARBIDE – NAVIGATOR TOOL MATERIALS

Carbide materials

Carbide Materials (or Hard Materials)		<p>A sintered powder metallurgy substrate, consisting of a metallic carbide composite with binder metal. The most central raw material is tungsten carbide (WC). Tungsten carbide contributes to the hardness of the material. Tantalum carbide (TaC), titanium carbide (TiC) and niobium carbide (NbC) complements WC and adjusts the properties to what is desired. These three materials are called cubic carbides. Cobalt (Co) acts as a binder and keeps the material together.</p> <p>Carbide materials are often characterised by high compression strength, high hardness and therefore high wear resistance, but also by limited flexural strength and toughness. Carbide is used in taps, reamers, milling cutters, drills and thread milling cutters.</p>
--	---	---



Surface Coatings

Bright (uncoated)		Bright finish (uncoated surface) improves chip flow in soft or non-ferrous materials, plastics and composites while maintaining sharp cutting edges.
Titanium Nitride coating (TiN)		Titanium Nitride is a gold coloured ceramic coating applied by physical vapor deposition (PVD). High hardness combined with low friction properties ensures longer tool life and/or better cutting performance from tools which have not been coated.
Titanium Aluminium Nitride coatings (TiAlN)		Titanium Aluminium Nitride is a multi layer ceramic coating applied by PVD coating technology, which exhibits high toughness and oxidation stability. These properties make it ideal for higher speeds and feeds, while at the same time improving tool life. TiAlN is used in drilling, tapping, and milling applications and can be suitable for use when machining without coolant. TiAlN-Top coating is the same as TiAlN but with a post-coating process designed to smooth out imperfections, enhance chip flow and reduce built up edge.



HSS DRILLS – NAVIGATOR TOOL MATERIALS





Tool materials

High Speed Steel		A medium-alloyed high speed steel that has good machinability and good performance. HSS exhibits hardness, toughness and wear resistance characteristics that make it attractive in a wide range of applications, for example in drills and taps.
Cobalt High Speed Steel		This high speed steel contains cobalt for increased hot hardness. The composition of HSCo is a good combination of toughness and hardness. It has good machinability and good wear resistance, which makes it usable for drills, taps, milling cutters and reamers.





Carbide materials

Carbide and High Speed Steel		Combined carbide and high speed steel materials typically joined together with high temperature braze alloy as the interface. This brazed combination of tool materials offers a solid carbide cutting portion which provides high compression strength, hardness and wear resistance attached to a high speed steel body which provides flexural strength and toughness in the tool body.
-------------------------------------	---	--

Surface Treatments

Bright (uncoated)		Bright finish (uncoated surface) improves chip flow in soft or non-ferrous materials, plastics and composites while maintaining sharp cutting edges.
Combination Bright and Steam Tempered		Combination of bright and steam tempering can be effective as the blue oxide more porous surface acts to retain and pull cutting fluid into the hole while the bright surface assists in chip evacuation. This combination is achieved by grinding the bright surface after tempering.
Steam Tempering		Steam tempering gives a strongly adhering blue oxide surface that acts to retain cutting fluid and prevent chip to tool welding, thereby counteracting the formation of a built-up edge. Steam tempering can be applied to any bright tool but is most effective on drills and taps.
Bronze Tempering		Bronze tempering creates a smooth thin bronze oxide layer on the tool surface. Similar to Steam Tempering it helps to prevent chip to tool welding and aids in chip evacuation. Bronze tempering can be applied to any bright tool and can also be applied in combination with Steam Tempering on some tools.

Surface Coatings

Bright and TiN (Tip Coating)		Titanium Nitride is a gold coloured ceramic coating applied by physical vapor deposition (PVD). High hardness combined with low friction properties ensures longer tool life and/or better cutting performance over tools which have not been coated.
Titanium Nitride (TiN)		Titanium Nitride is a gold coloured ceramic coating applied by physical vapor deposition (PVD). High hardness combined with low friction properties ensures longer tool life and/or better cutting performance over tools which have not been coated.
Titanium Aluminium Nitride coatings (TiAlN, TiAlN-Top & X-CEED)	 	Titanium Aluminium Nitride is a multi layer ceramic coating applied by PVD coating technology, which exhibits high toughness and oxidation stability. These properties make it ideal for higher speeds and feeds, while at the same time improving tool life. TiAlN is used in drilling, tapping, and milling applications and can be suitable for use when machining without coolant. TiAlN-Top coating is the same as TiAlN but with a post-coating process designed to smooth out imperfections, enhance chip flow and reduce built up edge.
Alcrona coatings (Alcrona-Top)		The Alcrona (AlCrN) family of coatings are aluminium chromium nitride coatings mostly used for milling cutters. The two unique properties of these coatings are high hot hardness and high oxidation resistance. When used on tools for machining applications involving heavy mechanical and thermal stresses, these properties translate into superior wear resistance. Multiple levels or specific versions of these coatings are available and specific for various tools and applications.



Material code (BMC)	HSS-E	HSS HM	HSS HM	HSS HM	HSS-E	HSS-E	HM								
Basic standard group (BSG)	DIN 1897	DIN 8037	DIN 338	DIN 345	DIN 345	DIN 338	DIN 6537K								
Usable length (ULDR)	2.5xD	2.5xD	4xD	4xD	4xD	4xD	3xD								
Application angle	135°	118°	118°	118°	118°	135°	140°								
Coating	Bronze	Bright ST	Bright ST	Bright ST	Bronze	Bronze	TiAlN								
Shank							DIN 6535MA								
Spiral form	λ 20-35°	λ 10-20°	λ 20-35°	λ 20-35°	λ 20-35°	λ 20-35°	CTW								
Hand (Cutting direction)	R	R	R	R	R	R	R								
Cooling (CSP)															
Product Family Code	A117	A124	A160	A166	A730	A777	R457								
	1.00 - 13.00	3.00 - 16.00	4.00 - 16.00	10.00 - 33.00	10.00 - 32.00	0.30 - 16.00	3.00 - 20.00								
	441	443	444	445	446	448	450								
P	P1	■	■	■	■	■	■								
	P2	■	■	■	■	■	■								
	P3	■	■	■	■	■	■								
	P4	■	■	■	■	■	■								
M	M1	■	■	■	■	■	■								
	M2	■	■	■	■	■	■								
	M3	■	■	■	■	■	■								
	M4	■	■	■	■	■	■								
K	K1	■	■	■	■	■	■								
	K2	■	■	■	■	■	■								
	K3	■	■	■	■	■	■								
	K4	■	■	■	■	■	■								
	K5	■	■	■	■	■	■								
N	N1	■	■	■	■	■	■								
	N2	■	■	■	■	■	■								
	N3	■	■	■	■	■	■								
	N4	■	■	■	■	■	■								
	N5	■	■	■	■	■	■								
S	S1	■	■	■	■	■	■								
	S2	■	■	■	■	■	■								
	S3	■	■	■	■	■	■								
	S4	■	■	■	■	■	■								
H	H1						■								
	H2						■								
	H3						■								
	H4														

FORCE X

■ Primary use ■ Possible use



A117



HSS-E (8% Cobalt) Stub Drill, Bronze Tempered Finish

Drill recommended for use in difficult materials and applications. A 135° split point makes self-centering easier and also reduces the cutting forces. Can be relied on to produce a precise hole and quality finish. The bronze finish is a thin oxide layer and it is an indication for Cobalt.

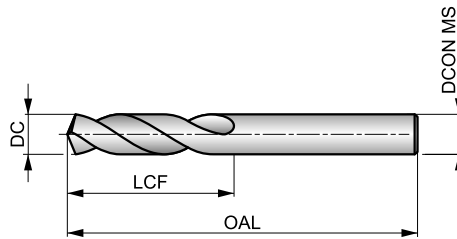

HSS-E	DIN 1897	2.5×D
135°	Bronze	
λ 20-35°	R	DC h8

Workpiece material group suitability, starting values for cutting speed (m/min) and feed Alpha Code. Tables with feed per revolution can be found starting from page XY.

P1.1 ■ 40 H	P1.2 ■ 45 H	P1.3 ■ 46 H	P2.1 ■ 34 H	P2.2 ■ 30 G	P2.3 ■ 27 F	P3.1 ■ 27 G	P3.2 ■ 21 G	P3.3 ■ 18 F	P4.1 ■ 16 G	P4.2 ■ 13 F	P4.3 ■ 11 E	M1.1 ■ 30 F	M1.2 ■ 26 F
M2.1 ■ 27 F	M2.2 ■ 22 F	M3.1 ■ 13 H	M3.2 ■ 11 H	M3.3 ■ 10 H	M4.1 ■ 15 D	K1.1 ■ 34 K	K1.2 ■ 25 F	K1.3 ■ 19 F	K2.1 ■ 27 F	K2.2 ■ 22 F	K2.3 ■ 18 F	K3.1 ■ 24 F	K3.2 ■ 18 F
K3.3 ■ 15 F	K4.1 ■ 22 F	K4.2 ■ 17 F	K4.3 ■ 12 F	K4.4 ■ 11 F	K4.5 ■ 9 F	K5.1 ■ 25 F	K5.2 ■ 19 F	K5.3 ■ 15 F	N1.1 ■ 35 K	N1.2 ■ 26 K	N1.3 ■ 18 J	N2.1 ■ 48 I	N2.2 ■ 43 I
N2.3 ■ 31 I	N3.1 ■ 68 J	N3.2 ■ 40 K	N3.3 ■ 20 I	N4.1 ■ 35 M	N4.2 ■ 28 K	N4.3 ■ 17 I	S1.1 ■ 30 G	S1.2 ■ 18 F	S1.3 ■ 10 C	S2.1 ■ 12 F	S2.2 ■ 8 C	S3.1 ■ 9 F	S3.2 ■ 6 C
S4.1 ■ 7 F	S4.2 ■ 5 C												

DC ≤ 1.5mm 118° point; DC < 3.00mm 5% cobalt.

Product	DC (inch)	DC (mm)	DC (inch)	LCF (mm)	OAL (mm)	DCON MS (mm)	Product	DC (inch)	DC (mm)	DC (inch)	LCF (mm)	OAL (mm)	DCON MS (mm)
A1171.0	–	1.00	0.0394	6.0	26.0	1.00	A1173.2	–	3.20	0.1260	18.0	49.0	3.20
A1171.1	–	1.10	0.0433	7.0	28.0	1.10	A1173.3	–	3.30	0.1299	18.0	49.0	3.30
A1171.2	–	1.20	0.0472	8.0	30.0	1.20	A1173.4	–	3.40	0.1339	20.0	52.0	3.40
A1171.3	–	1.30	0.0512	8.0	30.0	1.30	A1173.5	–	3.50	0.1378	20.0	52.0	3.50
A1171.4	–	1.40	0.0551	9.0	32.0	1.40	A1173.6	–	3.60	0.1417	20.0	52.0	3.60
A1171.5	–	1.50	0.0591	9.0	32.0	1.50	A1173.7	–	3.70	0.1457	20.0	52.0	3.70
A1171.6	–	1.60	0.0630	10.0	34.0	1.60	A1173.8	–	3.80	0.1496	22.0	55.0	3.80
A1171.7	–	1.70	0.0669	10.0	34.0	1.70	A1173.9	–	3.90	0.1535	22.0	55.0	3.90
A1171.8	–	1.80	0.0709	11.0	36.0	1.80	A1175/32	5/32	3.97	0.1563	22.0	55.0	3.97
A1171.9	–	1.90	0.0748	11.0	36.0	1.90	A1174.0	–	4.00	0.1575	22.0	55.0	4.00
A1172.0	–	2.00	0.0787	12.0	38.0	2.00	A1174.1	–	4.10	0.1614	22.0	55.0	4.10
A1172.1	–	2.10	0.0827	12.0	38.0	2.10	A1174.2	–	4.20	0.1654	22.0	55.0	4.20
A1172.2	–	2.20	0.0866	13.0	40.0	2.20	A1174.3	–	4.30	0.1693	24.0	58.0	4.30
A1172.3	–	2.30	0.0906	13.0	40.0	2.30	A1174.4	–	4.40	0.1732	24.0	58.0	4.40
A1172.4	–	2.40	0.0945	14.0	43.0	2.40	A1174.5	–	4.50	0.1772	24.0	58.0	4.50
A1172.5	–	2.50	0.0984	14.0	43.0	2.50	A1174.6	–	4.60	0.1811	24.0	58.0	4.60
A1172.6	–	2.60	0.1024	14.0	43.0	2.60	A1174.7	–	4.70	0.1850	24.0	58.0	4.70
A1172.7	–	2.70	0.1063	16.0	46.0	2.70	A1173/16	3/16	4.76	0.1875	26.0	62.0	4.76
A1172.8	–	2.80	0.1102	16.0	46.0	2.80	A1174.8	–	4.80	0.1890	26.0	62.0	4.80
A1172.9	–	2.90	0.1142	16.0	46.0	2.90	A1174.9	–	4.90	0.1929	26.0	62.0	4.90
A1173.0	–	3.00	0.1181	16.0	46.0	3.00	A1175.0	–	5.00	0.1969	26.0	62.0	5.00
A1173.1	–	3.10	0.1220	18.0	49.0	3.10	A1175.1	–	5.10	0.2008	26.0	62.0	5.10
A1171/8	1/8	3.18	0.1250	18.0	49.0	3.18	A1175.2	–	5.20	0.2047	26.0	62.0	5.20



Product	DC	DC	DC	LCF	OAL	DCON MS
	(inch)	(mm)	(inch)	(mm)	(mm)	(mm)
A1175.3	–	5.30	0.2087	26.0	62.0	5.30
A1175.4	–	5.40	0.2126	28.0	66.0	5.40
A1175.5	–	5.50	0.2165	28.0	66.0	5.50
A1175.6	–	5.60	0.2205	28.0	66.0	5.60
A1175.7	–	5.70	0.2244	28.0	66.0	5.70
A1175.8	–	5.80	0.2283	28.0	66.0	5.80
A1175.9	–	5.90	0.2323	28.0	66.0	5.90
A1176.0	–	6.00	0.2362	28.0	66.0	6.00
A1176.1	–	6.10	0.2402	31.0	70.0	6.10
A1176.2	–	6.20	0.2441	31.0	70.0	6.20
A1176.3	–	6.30	0.2480	31.0	70.0	6.30
A1171/4	1/4	6.35	0.2500	31.0	70.0	6.35
A1176.4	–	6.40	0.2520	31.0	70.0	6.40
A1176.5	–	6.50	0.2559	31.0	70.0	6.50
A1176.6	–	6.60	0.2598	31.0	70.0	6.60
A1176.7	–	6.70	0.2638	31.0	70.0	6.70
A1176.8	–	6.80	0.2677	34.0	74.0	6.80
A1176.9	–	6.90	0.2717	34.0	74.0	6.90
A1177.0	–	7.00	0.2756	34.0	74.0	7.00
A1177.1	–	7.10	0.2795	34.0	74.0	7.10
A1177.2	–	7.20	0.2835	34.0	74.0	7.20
A1177.3	–	7.30	0.2874	34.0	74.0	7.30
A1177.4	–	7.40	0.2913	34.0	74.0	7.40
A1177.5	–	7.50	0.2953	34.0	74.0	7.50
A1177.6	–	7.60	0.2992	37.0	79.0	7.60
A1177.7	–	7.70	0.3031	37.0	79.0	7.70
A1177.8	–	7.80	0.3071	37.0	79.0	7.80
A1177.9	–	7.90	0.3110	37.0	79.0	7.90
A1175/16	5/16	7.94	0.3125	37.0	79.0	7.94

Product	DC	DC	DC	LCF	OAL	DCON MS
	(inch)	(mm)	(inch)	(mm)	(mm)	(mm)
A1178.0	–	8.00	0.3150	37.0	79.0	8.00
A1178.1	–	8.10	0.3189	37.0	79.0	8.10
A1178.2	–	8.20	0.3228	37.0	79.0	8.20
A1178.3	–	8.30	0.3268	37.0	79.0	8.30
A1178.4	–	8.40	0.3307	37.0	79.0	8.40
A1178.5	–	8.50	0.3346	37.0	79.0	8.50
A1178.6	–	8.60	0.3386	40.0	84.0	8.60
A1178.7	–	8.70	0.3425	40.0	84.0	8.70
A1178.8	–	8.80	0.3465	40.0	84.0	8.80
A1178.9	–	8.90	0.3504	40.0	84.0	8.90
A1179.0	–	9.00	0.3543	40.0	84.0	9.00
A1179.1	–	9.10	0.3583	40.0	84.0	9.10
A1179.2	–	9.20	0.3622	40.0	84.0	9.20
A1179.3	–	9.30	0.3661	40.0	84.0	9.30
A1179.4	–	9.40	0.3701	40.0	84.0	9.40
A1179.5	–	9.50	0.3740	40.0	84.0	9.50
A1173/8	3/8	9.52	0.3750	43.0	89.0	9.52
A1179.6	–	9.60	0.3780	43.0	89.0	9.60
A1179.7	–	9.70	0.3819	43.0	89.0	9.70
A1179.8	–	9.80	0.3858	43.0	89.0	9.80
A1179.9	–	9.90	0.3898	43.0	89.0	9.90
A11710.0	–	10.00	0.3937	43.0	89.0	10.00
A11710.2	–	10.20	0.4016	43.0	89.0	10.20
A11710.5	–	10.50	0.4134	43.0	89.0	10.50
A11711.0	–	11.00	0.4331	47.0	95.0	11.00
A11711.5	–	11.50	0.4528	47.0	95.0	11.50
A11712.0	–	12.00	0.4724	51.0	102.0	12.00
A1171/2	1/2	12.70	0.5000	51.0	102.0	12.70
A11713.0	–	13.00	0.5118	51.0	102.0	13.00



A124



HSS Stub Drill, Steam Tempered Finish, with Brazed Carbide Point

Brazed carbide tip gives the high performance of a carbide drill with a strong and less brittle HSS body. A 118°, 4-facet point, helps with self-centering making it an economical choice. It can be used in both conventional and CNC machines. Steam tempered finish retains cutting fluid.

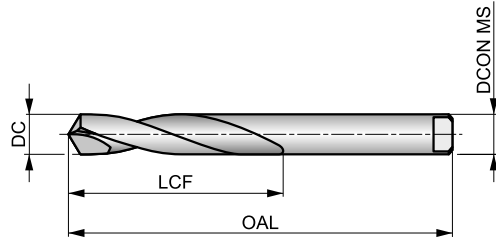

HSS HM	DIN 8037	2.5×D
118°	Bright ST	
10-20°		

Workpiece material group suitability, starting values for cutting speed (m/min) and feed Alpha Code. Tables with feed per revolution can be found starting from page XY.

P2.3 ■ 40 C	P3.3 ■ 40 C	P4.2 ■ 30 C	P4.3 ■ 24 A	M3.1 ■ 41 C	M3.2 ■ 35 C	M3.3 ■ 32 C	M4.1 ■ 35 C	K1.1 ■ 55 C	K1.2 ■ 41 C	K1.3 ■ 31 C	K2.1 ■ 49 C	K2.2 ■ 40 C	K2.3 ■ 32 A
K3.1 ■ 44 C	K3.2 ■ 33 C	K3.3 ■ 27 A	K4.1 ■ 40 C	K4.2 ■ 30 C	K4.3 ■ 22 A	K4.4 ■ 19 A	K4.5 ■ 16 A	K5.1 ■ 46 C	K5.2 ■ 34 C	K5.3 ■ 27 A	N3.1 ■ 119 E	N3.2 ■ 70 G	N4.2 ■ 60 E
S1.1 ■ 40 A	S1.2 ■ 35 A	S1.3 ■ 25 A	S2.1 ■ 33 A	S2.2 ■ 28 A	S3.1 ■ 25 A	S3.2 ■ 20 A	S4.1 ■ 20 A	S4.2 ■ 16 A					

Tang to DIN 1809.

Product	DC	DC	LCF	OAL	DCON MS
	(mm)	(inch)			
A1243.0	3.00	0.1181	20.0	50.0	3.00
A1243.2	3.20	0.1260	25.0	56.0	3.20
A1243.5	3.50	0.1378	25.0	56.0	3.50
A1244.0	4.00	0.1575	25.0	56.0	4.00
A1244.2	4.20	0.1654	28.0	63.0	4.20
A1244.5	4.50	0.1772	28.0	63.0	4.50
A1244.8	4.80	0.1890	28.0	63.0	4.80
A1245.0	5.00	0.1969	28.0	63.0	5.00
A1245.2	5.20	0.2047	32.0	71.0	5.20
A1245.5	5.50	0.2165	32.0	71.0	5.50
A1245.8	5.80	0.2283	32.0	71.0	5.80
A1246.0	6.00	0.2362	32.0	71.0	6.00
A1246.5	6.50	0.2559	32.0	71.0	6.50
A1246.8	6.80	0.2677	40.0	80.0	6.80
A1247.0	7.00	0.2756	40.0	80.0	7.00

Product	DC	DC	LCF	OAL	DCON MS
	(mm)	(inch)			
A1247.5	7.50	0.2953	40.0	80.0	7.50
A1248.0	8.00	0.3150	40.0	80.0	8.00
A1248.5	8.50	0.3346	50.0	90.0	8.50
A1249.0	9.00	0.3543	50.0	90.0	9.00
A1249.5	9.50	0.3740	50.0	90.0	9.50
A12410.0	10.00	0.3937	56.0	100.0	10.00
A12410.5	10.50	0.4134	56.0	100.0	10.50
A12411.0	11.00	0.4331	56.0	100.0	11.00
A12411.5	11.50	0.4528	63.0	112.0	11.50
A12412.0	12.00	0.4724	63.0	112.0	12.00
A12413.0	13.00	0.5118	63.0	112.0	13.00
A12414.0	14.00	0.5512	71.0	125.0	14.00
A12415.0	15.00	0.5906	71.0	125.0	15.00
A12416.0	16.00	0.6299	80.0	140.0	16.00



A160



HSS Jobber Drill, Steam Tempered Finish, with Brazed Carbide Point

HSS body with a brazed carbide tip, giving the performance of a carbide drill with a strong and flexible body. It has a 118°, 4-facet self-centering point making it an economical choice when drilling cast iron materials. It can be used in both conventional and CNC machines.

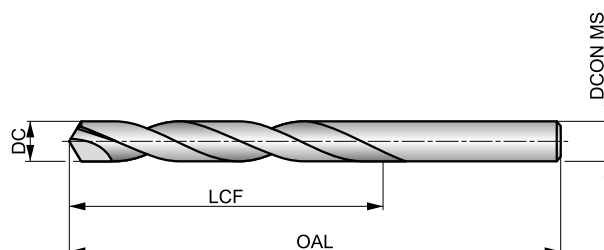

HSS HM	DIN 338	4×D
118°	Bright ST	
λ 20-35°	R	DC h8

Workpiece material group suitability, starting values for cutting speed (m/min) and feed Alpha Code. Tables with feed per revolution can be found starting from page XY.

P1.1 ▣73 E	P1.2 ▣82 E	P1.3 ▣85 E	P2.1 ▣63 E	P2.2 ▣55 D	P2.3 ▣49 C	P3.1 ▣59 D	P3.2 ▣47 D	P3.3 ▣40 C	P4.1 ▣35 D	P4.2 ▣30 C	P4.3 ▣24 A	M1.1 ▣55 B	M1.2 ▣46 B
M2.1 ▣49 B	M2.2 ▣40 B	M3.1 ▣41 C	M3.2 ▣35 C	M3.3 ▣32 C	M4.1 ▣35 A	K1.1 ▣50 C	K1.2 ▣37 A	K1.3 ▣28 A	K2.1 ▣43 A	K2.2 ▣35 A	K2.3 ▣28 A	K3.1 ▣38 A	K3.2 ▣29 A
K3.3 ▣24 A	K4.1 ▣35 A	K4.2 ▣27 A	K4.3 ▣20 A	K4.4 ▣17 A	K4.5 ▣14 A	K5.1 ▣40 A	K5.2 ▣30 A	K5.3 ▣23 A	N1.1 ▣50 I	N1.2 ▣38 I	N1.3 ▣25 H	N2.1 ▣62 G	N2.2 ▣55 G
N2.3 ▣40 G	N3.1 ▣119 C	N3.2 ▣70 G	N3.3 ▣35 D	N4.2 ▣60 E	S1.1 ▣35 A	S1.2 ▣35 A	S1.3 ▣25 A	S2.1 ▣33 A	S2.2 ▣28 A	S3.1 ▣25 A	S3.2 ▣20 A	S4.1 ▣20 A	S4.2 ▣16 A

Product	DC	DC	LCF	OAL	DCON MS
	(mm)	(inch)			
A1604.0	4.00	0.1575	43.0	75.0	4.00
A1604.5	4.50	0.1772	47.0	80.0	4.50
A1605.0	5.00	0.1969	52.0	86.0	5.00
A1605.5	5.50	0.2165	57.0	93.0	5.50
A1606.0	6.00	0.2362	57.0	93.0	6.00
A1606.5	6.50	0.2559	63.0	101.0	6.50
A1606.8	6.80	0.2677	69.0	109.0	6.80
A1607.0	7.00	0.2756	69.0	109.0	7.00
A1607.5	7.50	0.2953	69.0	109.0	7.50
A1608.0	8.00	0.3150	75.0	117.0	8.00
A1608.5	8.50	0.3346	75.0	117.0	8.50
A1609.0	9.00	0.3543	81.0	125.0	9.00
A1609.5	9.50	0.3740	81.0	125.0	9.50
A16010.0	10.00	0.3937	87.0	133.0	10.00
A16010.2	10.20	0.4016	87.0	133.0	10.20
A16010.5	10.50	0.4134	87.0	133.0	10.50
A16011.0	11.00	0.4331	94.0	142.0	11.00
A16011.5	11.50	0.4528	94.0	142.0	11.50
A16012.0	12.00	0.4724	101.0	151.0	12.00
A16013.0	13.00	0.5118	101.0	151.0	13.00
A16014.0	14.00	0.5512	108.0	160.0	14.00
A16015.0	15.00	0.5906	114.0	169.0	15.00
A16016.0	16.00	0.6299	120.0	178.0	16.00



A166



HSS Taper Shank Drill, Steam Tempered Finish, with Brazed Carbide Point

Brazed carbide tip gives the high performance of a carbide drill with a strong and less brittle HSS body. It has a 118°, four-facet point which helps with self-centering and is easy to regrind, making it an economical choice when drilling cast iron materials.

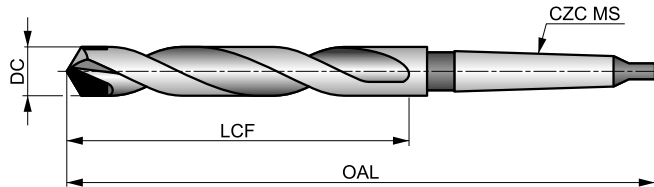

HSS HM	DIN 345	4xD
118°	Bright ST	
20-35°	R	DC h8

Workpiece material group suitability, starting values for cutting speed (m/min) and feed Alpha Code. Tables with feed per revolution can be found starting from page XY.

P1.1 ▣73 E	P1.2 ▣82 E	P1.3 ▣85 E	P2.1 ▣63 E	P2.2 ▣55 D	P2.3 ▣49 C	P3.1 ▣59 D	P3.2 ▣47 D	P3.3 ▣40 C	P4.1 ▣35 D	P4.2 ▣30 C	P4.3 ▣24 A	M1.1 ▣55 B	M1.2 ▣46 B
M2.1 ▣49 B	M2.2 ▣40 B	M3.1 ▣41 C	M3.2 ▣35 C	M3.3 ▣32 C	M4.1 ▣35 A	K1.1 ▣50 C	K1.2 ▣37 C	K1.3 ▣28 C	K2.1 ▣43 C	K2.2 ▣35 C	K2.3 ▣28 A	K3.1 ▣38 C	K3.2 ▣29 C
K3.3 ▣24 A	K4.1 ▣35 C	K4.2 ▣27 C	K4.3 ▣20 A	K4.4 ▣17 A	K4.5 ▣14 A	K5.1 ▣40 C	K5.2 ▣30 C	K5.3 ▣23 A	N1.1 ▣50 I	N1.2 ▣38 I	N1.3 ▣25 H	N2.1 ▣62 G	N2.2 ▣55 G
N2.3 ▣40 G	N3.1 ▣127 C	N3.2 ▣75 G	N3.3 ▣38 D	N4.2 ▣60 E	S1.1 ▣35 A	S1.2 ▣35 A	S1.3 ▣25 A	S2.1 ▣33 A	S2.2 ▣28 A	S3.1 ▣25 A	S3.2 ▣20 A	S4.1 ▣20 A	S4.2 ▣16 A

Product	DC	DC	LCF	OAL	CZC MS	Product	DC	DC	LCF	OAL	CZC MS
	(mm)	(inch)					(mm)	(mm)			
A16610.0	10.00	0.3937	87.0	168.0	MK 1	A16620.0	20.00	0.7874	140.0	238.0	MK 2
A16610.5	10.50	0.4134	87.0	168.0	MK 1	A16621.0	21.00	0.8268	145.0	243.0	MK 2
A16611.0	11.00	0.4331	94.0	175.0	MK 1	A16622.0	22.00	0.8661	150.0	248.0	MK 2
A16611.5	11.50	0.4528	94.0	175.0	MK 1	A16622.5	22.50	0.8858	155.0	253.0	MK 2
A16612.0	12.00	0.4724	101.0	182.0	MK 1	A16623.0	23.00	0.9055	155.0	253.0	MK 2
A16613.0	13.00	0.5118	101.0	182.0	MK 1	A16624.0	24.00	0.9449	160.0	281.0	MK 3
A16613.5	13.50	0.5315	108.0	189.0	MK 1	A16625.0	25.00	0.9843	160.0	281.0	MK 3
A16614.0	14.00	0.5512	108.0	189.0	MK 1	A16626.0	26.00	1.0236	165.0	286.0	MK 3
A16615.0	15.00	0.5906	114.0	212.0	MK 2	A16627.0	27.00	1.0630	170.0	291.0	MK 3
A16616.0	16.00	0.6299	120.0	218.0	MK 2	A16628.0	28.00	1.1024	170.0	291.0	MK 3
A16617.0	17.00	0.6693	125.0	223.0	MK 2	A16629.0	29.00	1.1417	175.0	296.0	MK 3
A16617.5	17.50	0.6890	130.0	228.0	MK 2	A16630.0	30.00	1.1811	175.0	296.0	MK 3
A16618.0	18.00	0.7087	130.0	228.0	MK 2	A16632.0	32.00	1.2598	185.0	334.0	MK 4
A16619.0	19.00	0.7480	135.0	233.0	MK 2	A16633.0	33.00	1.2992	185.0	334.0	MK 4



A730



HSS-E (8% Cobalt) Taper Shank Drill, Bronze Tempered Finish

Recommended for difficult materials and applications. The 118° point provides a strong point which is easy to regrind. Suitable for drilling many materials. The bronze finish is a thin oxide layer and it is an indication for Cobalt.

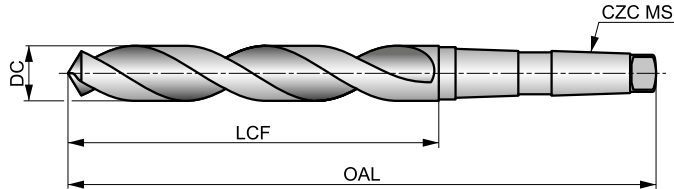

HSS-E	DIN 345	4xD
118°	Bronze	
λ 20-35°	R	DC h8

Workpiece material group suitability, starting values for cutting speed (m/min) and feed Alpha Code. Tables with feed per revolution can be found starting from page XY.

P1.1 ■ 36 H	P1.2 ■ 40 H	P1.3 ■ 41 H	P2.1 ■ 31 H	P2.2 ■ 27 G	P2.3 ■ 24 E	P3.1 ■ 25 F	P3.2 ■ 20 F	P3.3 ■ 17 E	P4.1 ■ 15 F	P4.2 ■ 13 E	P4.3 ■ 10 D	M1.1 ■ 33 E	M1.2 ■ 28 E
M2.1 ■ 29 E	M2.2 ■ 24 E	M3.1 ■ 13 G	M3.2 ■ 11 G	M3.3 ■ 10 G	M4.1 ■ 17 C	K1.1 ■ 35 J	K1.2 ■ 26 G	K1.3 ■ 19 G	K2.1 ■ 27 E	K2.2 ■ 22 E	K2.3 ■ 18 E	K3.1 ■ 24 E	K3.2 ■ 18 E
K3.3 ■ 15 E	K4.1 ■ 22 E	K4.2 ■ 17 E	K4.3 ■ 12 E	K4.4 ■ 11 E	K4.5 ■ 9 E	K5.1 ■ 25 E	K5.2 ■ 19 E	K5.3 ■ 15 E	N1.1 ■ 33 J	N1.2 ■ 25 J	N1.3 ■ 17 I	N2.1 ■ 46 H	N2.2 ■ 42 H
N2.3 ■ 30 H	N3.1 ■ 68 H	N3.2 ■ 40 J	N3.3 ■ 20 L	N4.1 ■ 35 K	N4.2 ■ 28 J	N4.3 ■ 20 H	S1.1 ■ 28 G	S1.2 ■ 20 D	S1.3 ■ 11 C	S2.1 ■ 9 E	S2.2 ■ 8 B	S3.1 ■ 7 E	S3.2 ■ 6 B
S4.1 ■ 5 E	S4.2 ■ 5 B												

DC >= 14mm Point Thinned.

Product	DC	DC	LCF	OAL	CZC MS	Product	DC	DC	LCF	OAL	CZC MS
	(mm)	(inch)					(mm)	(mm)			
A73010.0	10.00	0.3937	87.0	168.0	MK 1	A73016.25	16.25	0.6398	120.0	218.0	MK 2
A73010.2	10.20	0.4016	87.0	168.0	MK 1	A73016.5	16.50	0.6496	125.0	223.0	MK 2
A73010.5	10.50	0.4134	87.0	168.0	MK 1	A73017.0	17.00	0.6693	125.0	223.0	MK 2
A73010.8	10.80	0.4252	94.0	175.0	MK 1	A73017.25	17.25	0.6791	130.0	228.0	MK 2
A73011.0	11.00	0.4331	94.0	175.0	MK 1	A73017.5	17.50	0.6890	130.0	228.0	MK 2
A73011.5	11.50	0.4528	94.0	175.0	MK 1	A73017.75	17.75	0.6988	130.0	228.0	MK 2
A73011.8	11.80	0.4646	94.0	175.0	MK 1	A73018.0	18.00	0.7087	130.0	228.0	MK 2
A73012.0	12.00	0.4724	101.0	182.0	MK 1	A73018.25	18.25	0.7185	135.0	233.0	MK 2
A73012.2	12.20	0.4803	101.0	182.0	MK 1	A73018.5	18.50	0.7283	135.0	233.0	MK 2
A73012.5	12.50	0.4921	101.0	182.0	MK 1	A73018.75	18.75	0.7382	135.0	233.0	MK 2
A73012.8	12.80	0.5039	101.0	182.0	MK 1	A73019.0	19.00	0.7480	135.0	233.0	MK 2
A73013.0	13.00	0.5118	101.0	182.0	MK 1	A73019.25	19.25	0.7579	140.0	238.0	MK 2
A73013.5	13.50	0.5315	108.0	189.0	MK 1	A73019.5	19.50	0.7677	140.0	238.0	MK 2
A73013.8	13.80	0.5433	108.0	189.0	MK 1	A73019.75	19.75	0.7776	140.0	238.0	MK 2
A73014.0	14.00	0.5512	108.0	189.0	MK 1	A73020.0	20.00	0.7874	140.0	238.0	MK 2
A73014.25	14.25	0.5610	114.0	212.0	MK 2	A73020.25	20.25	0.7972	145.0	243.0	MK 2
A73014.5	14.50	0.5709	114.0	212.0	MK 2	A73020.5	20.50	0.8071	145.0	243.0	MK 2
A73014.75	14.75	0.5807	114.0	212.0	MK 2	A73020.75	20.75	0.8169	145.0	243.0	MK 2
A73015.0	15.00	0.5906	114.0	212.0	MK 2	A73021.0	21.00	0.8268	145.0	243.0	MK 2
A73015.25	15.25	0.6004	120.0	218.0	MK 2	A73021.5	21.50	0.8465	150.0	248.0	MK 2
A73015.5	15.50	0.6102	120.0	218.0	MK 2	A73022.0	22.00	0.8661	150.0	248.0	MK 2
A73015.75	15.75	0.6201	120.0	218.0	MK 2	A73022.5	22.50	0.8858	155.0	253.0	MK 2
A73016.0	16.00	0.6299	120.0	218.0	MK 2	A73023.0	23.00	0.9055	155.0	253.0	MK 2



Product	DC	DC	LCF	OAL	CZC MS
	(mm)	(inch)	(mm)	(mm)	
A73023.5	23.50	0.9252	155.0	276.0	MK 3
A73024.0	24.00	0.9449	160.0	281.0	MK 3
A73024.5	24.50	0.9646	160.0	281.0	MK 3
A73025.0	25.00	0.9843	160.0	281.0	MK 3
A73025.5	25.50	1.0039	165.0	286.0	MK 3
A73026.0	26.00	1.0236	165.0	286.0	MK 3
A73026.5	26.50	1.0433	165.0	286.0	MK 3
A73027.0	27.00	1.0630	170.0	291.0	MK 3

Product	DC	DC	LCF	OAL	CZC MS
	(mm)	(inch)	(mm)	(mm)	
A73027.5	27.50	1.0827	170.0	291.0	MK 3
A73028.0	28.00	1.1024	170.0	291.0	MK 3
A73028.5	28.50	1.1220	175.0	296.0	MK 3
A73029.0	29.00	1.1417	175.0	296.0	MK 3
A73030.0	30.00	1.1811	175.0	296.0	MK 3
A73031.0	31.00	1.2205	180.0	301.0	MK 3
A73032.0	32.00	1.2598	185.0	334.0	MK 4



A777



HSS-E (8% Cobalt) Jobber Drill, Bronze Tempered Finish

A top performer, producing accurate sized holes with a quality finish in high strength materials. The 135° split point helps to self-center. The bronze finish is a thin oxide layer formed on the tool surface and is an indication for 8% Cobalt HSS-E Drill.

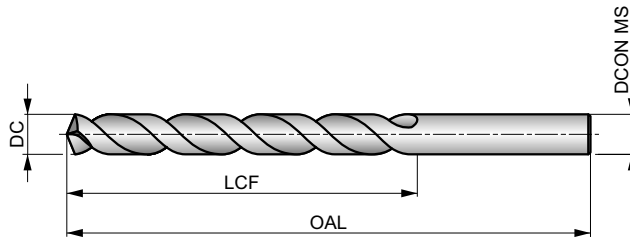

HSS-E	DIN 338	4xD
135°	Bronze	
λ 20-35°	R	DC h8

Workpiece material group suitability, starting values for cutting speed (m/min) and feed Alpha Code. Tables with feed per revolution can be found starting from page XY.

P1.1 ■ 36 H	P1.2 ■ 40 H	P1.3 ■ 41 H	P2.1 ■ 31 H	P2.2 ■ 27 G	P2.3 ■ 24 E	P3.1 ■ 25 F	P3.2 ■ 20 F	P3.3 ■ 17 E	P4.1 ■ 15 F	P4.2 ■ 13 E	P4.3 ■ 10 D	M1.1 ■ 30 E	M1.2 ■ 26 E
M2.1 ■ 27 E	M2.2 ■ 22 E	M3.1 ■ 13 G	M3.2 ■ 11 G	M3.3 ■ 10 G	M4.1 ■ 15 C	K1.1 ■ 35 H	K1.2 ■ 26 D	K1.3 ■ 19 D	K2.1 ■ 27 E	K2.2 ■ 22 E	K2.3 ■ 18 E	K3.1 ■ 24 E	K3.2 ■ 18 E
K3.3 ■ 15 E	K4.1 ■ 22 E	K4.2 ■ 17 E	K4.3 ■ 12 E	K4.4 ■ 11 E	K4.5 ■ 9 E	K5.1 ■ 25 E	K5.2 ■ 19 E	K5.3 ■ 15 E	N1.1 ■ 33 J	N1.2 ■ 25 J	N1.3 ■ 17 I	N2.1 ■ 46 H	N2.2 ■ 42 H
N2.3 ■ 30 H	N3.1 ■ 68 H	N3.2 ■ 40 F	N3.3 ■ 20 H	S1.1 ■ 28 F	S1.2 ■ 20 D	S1.3 ■ 11 C	S2.1 ■ 9 E	S2.2 ■ 8 B	S3.1 ■ 7 E	S3.2 ■ 6 B	S4.1 ■ 5 E	S4.2 ■ 5 B	

NAS907J. DC ≤ 1.4mm 4 Facet Point.

Products from this series are also available in set. Please see A295.

Product	DC (inch)	DC (mm)	DC (inch)	LCF (mm)	OAL (mm)	DCON MS (mm)
A777.3	—	0.30	0.0118	3.0	19.0	0.30
A777.35	—	0.35	0.0138	4.0	19.0	0.35
A777.4	—	0.40	0.0157	5.0	20.0	0.40
A777.45	—	0.45	0.0177	5.0	20.0	0.45
A777.5	—	0.50	0.0197	6.0	22.0	0.50
A777.55	—	0.55	0.0217	7.0	24.0	0.55
A777.6	—	0.60	0.0236	7.0	24.0	0.60
A777.65	—	0.65	0.0256	8.0	26.0	0.65
A777.7	—	0.70	0.0276	9.0	28.0	0.70
A777.8	—	0.80	0.0315	10.0	30.0	0.80
A777.9	—	0.90	0.0354	11.0	32.0	0.90
A777.95	—	0.95	0.0374	11.0	32.0	0.95
A7771.0	—	1.00	0.0394	12.0	34.0	1.00
A7771.1	—	1.10	0.0433	14.0	36.0	1.10
A7771.2	—	1.20	0.0472	16.0	38.0	1.20
A7771.3	—	1.30	0.0512	16.0	38.0	1.30
A7771.4	—	1.40	0.0551	18.0	40.0	1.40
A7771.5	—	1.50	0.0591	18.0	40.0	1.50
A7771/16	1/16	1.59	0.0625	20.0	43.0	1.59
A7771.6	—	1.60	0.0630	20.0	43.0	1.60
A7771.7	—	1.70	0.0669	20.0	43.0	1.70
A7771.8	—	1.80	0.0709	22.0	46.0	1.80
A7771.9	—	1.90	0.0748	22.0	46.0	1.90
A7775/64	5/64	1.98	0.0781	24.0	49.0	1.98

Product	DC (inch)	DC (mm)	DC (inch)	LCF (mm)	OAL (mm)	DCON MS (mm)
A7772.0	—	2.00	0.0787	24.0	49.0	2.00
A7772.1	—	2.10	0.0827	24.0	49.0	2.10
A7772.2	—	2.20	0.0866	27.0	53.0	2.20
A7772.3	—	2.30	0.0906	27.0	53.0	2.30
A7773/32	3/32	2.38	0.0938	30.0	57.0	2.38
A7772.4	—	2.40	0.0945	30.0	57.0	2.40
A7772.5	—	2.50	0.0984	30.0	57.0	2.50
A7772.6	—	2.60	0.1024	30.0	57.0	2.60
A7772.7	—	2.70	0.1063	33.0	61.0	2.70
A7777/64	7/64	2.78	0.1094	33.0	61.0	2.78
A7772.8	—	2.80	0.1102	33.0	61.0	2.80
A7772.9	—	2.90	0.1142	33.0	61.0	2.90
A7773.0	—	3.00	0.1181	33.0	61.0	3.00
A7773.1	—	3.10	0.1220	36.0	65.0	3.10
A7771/8	1/8	3.18	0.1250	36.0	65.0	3.18
A7773.2	—	3.20	0.1260	36.0	65.0	3.20
A7773.3	—	3.30	0.1299	36.0	65.0	3.30
A7773.4	—	3.40	0.1339	39.0	70.0	3.40
A7773.5	—	3.50	0.1378	39.0	70.0	3.50
A7779/64	9/64	3.57	0.1406	39.0	70.0	3.57
A7773.6	—	3.60	0.1417	39.0	70.0	3.60
A7773.7	—	3.70	0.1457	39.0	70.0	3.70
A7773.8	—	3.80	0.1496	43.0	75.0	3.80
A7773.9	—	3.90	0.1535	43.0	75.0	3.90



Product	DC	DC	DC	LCF	OAL	D CON MS
	(inch)	(mm)	(inch)	(mm)	(mm)	(mm)
A7775/32	5/32	3.97	0.1563	43.0	75.0	3.97
A7774.0	–	4.00	0.1575	43.0	75.0	4.00
A7774.1	–	4.10	0.1614	43.0	75.0	4.10
A7774.2	–	4.20	0.1654	43.0	75.0	4.20
A7774.3	–	4.30	0.1693	47.0	80.0	4.30
A77711/64	11/64	4.37	0.1719	47.0	80.0	4.37
A7774.4	–	4.40	0.1732	47.0	80.0	4.40
A7774.5	–	4.50	0.1772	47.0	80.0	4.50
A7774.6	–	4.60	0.1811	47.0	80.0	4.60
A7774.7	–	4.70	0.1850	47.0	80.0	4.70
A7773/16	3/16	4.76	0.1875	52.0	86.0	4.76
A7774.8	–	4.80	0.1890	52.0	86.0	4.80
A7774.9	–	4.90	0.1929	52.0	86.0	4.90
A7775.0	–	5.00	0.1969	52.0	86.0	5.00
A7775.1	–	5.10	0.2008	52.0	86.0	5.10
A77713/64	13/64	5.16	0.2031	52.0	86.0	5.16
A7775.2	–	5.20	0.2047	52.0	86.0	5.20
A7775.3	–	5.30	0.2087	52.0	86.0	5.30
A7775.4	–	5.40	0.2126	57.0	93.0	5.40
A7775.5	–	5.50	0.2165	57.0	93.0	5.50
A7777/32	7/32	5.56	0.2188	57.0	93.0	5.56
A7775.6	–	5.60	0.2205	57.0	93.0	5.60
A7775.7	–	5.70	0.2244	57.0	93.0	5.70
A7775.8	–	5.80	0.2283	57.0	93.0	5.80
A7775.9	–	5.90	0.2323	57.0	93.0	5.90
A77715/64	15/64	5.95	0.2344	57.0	93.0	5.95
A7776.0	–	6.00	0.2362	57.0	93.0	6.00
A7776.1	–	6.10	0.2402	63.0	101.0	6.10
A7776.2	–	6.20	0.2441	63.0	101.0	6.20
A7776.3	–	6.30	0.2480	63.0	101.0	6.30
A7771/4	1/4	6.35	0.2500	63.0	101.0	6.35
A7776.4	–	6.40	0.2520	63.0	101.0	6.40
A7776.5	–	6.50	0.2559	63.0	101.0	6.50
A7776.6	–	6.60	0.2598	63.0	101.0	6.60
A7776.7	–	6.70	0.2638	63.0	101.0	6.70
A77717/64	17/64	6.75	0.2656	69.0	109.0	6.75
A7776.8	–	6.80	0.2677	69.0	109.0	6.80
A7776.9	–	6.90	0.2717	69.0	109.0	6.90
A7777.0	–	7.00	0.2756	69.0	109.0	7.00
A7777.1	–	7.10	0.2795	69.0	109.0	7.10
A7779/32	9/32	7.14	0.2813	69.0	109.0	7.14
A7777.2	–	7.20	0.2835	69.0	109.0	7.20
A7777.3	–	7.30	0.2874	69.0	109.0	7.30
A7777.4	–	7.40	0.2913	69.0	109.0	7.40
A7777.5	–	7.50	0.2953	69.0	109.0	7.50
A77719/64	19/64	7.54	0.2969	75.0	117.0	7.54
A7777.6	–	7.60	0.2992	75.0	117.0	7.60
A7777.7	–	7.70	0.3031	75.0	117.0	7.70
A7777.8	–	7.80	0.3071	75.0	117.0	7.80
A7777.9	–	7.90	0.3110	75.0	117.0	7.90
A7775/16	5/16	7.94	0.3125	75.0	117.0	7.94
A7778.0	–	8.00	0.3150	75.0	117.0	8.00

Product	DC	DC	DC	LCF	OAL	D CON MS
	(inch)	(mm)	(inch)	(mm)	(mm)	(mm)
A7778.1	–	8.10	0.3189	75.0	117.0	8.10
A7778.2	–	8.20	0.3228	75.0	117.0	8.20
A7778.3	–	8.30	0.3268	75.0	117.0	8.30
A77721/64	21/64	8.33	0.3281	75.0	117.0	8.33
A7778.4	–	8.40	0.3307	75.0	117.0	8.40
A7778.5	–	8.50	0.3346	75.0	117.0	8.50
A7778.6	–	8.60	0.3386	81.0	125.0	8.60
A7778.7	–	8.70	0.3425	81.0	125.0	8.70
A77711/32	11/32	8.73	0.3438	81.0	125.0	8.73
A7778.8	–	8.80	0.3465	81.0	125.0	8.80
A7778.9	–	8.90	0.3504	81.0	125.0	8.90
A7779.0	–	9.00	0.3543	81.0	125.0	9.00
A7779.1	–	9.10	0.3583	81.0	125.0	9.10
A77723/64	23/64	9.13	0.3594	81.0	125.0	9.13
A7779.2	–	9.20	0.3622	81.0	125.0	9.20
A7779.3	–	9.30	0.3661	81.0	125.0	9.30
A7779.4	–	9.40	0.3701	81.0	125.0	9.40
A7779.5	–	9.50	0.3740	81.0	125.0	9.50
A7773/8	3/8	9.52	0.3750	87.0	133.0	9.52
A7779.6	–	9.60	0.3780	87.0	133.0	9.60
A7779.7	–	9.70	0.3819	87.0	133.0	9.70
A7779.8	–	9.80	0.3858	87.0	133.0	9.80
A7779.9	–	9.90	0.3898	87.0	133.0	9.90
A77725/64	25/64	9.92	0.3906	87.0	133.0	9.92
A77710.0	–	10.00	0.3937	87.0	133.0	10.00
A77710.1	–	10.10	0.3976	87.0	133.0	10.10
A77710.2	–	10.20	0.4016	87.0	133.0	10.20
A77713/32	13/32	10.32	0.4063	87.0	133.0	10.32
A77710.5	–	10.50	0.4134	87.0	133.0	10.50
A77727/64	27/64	10.72	0.4219	94.0	142.0	10.72
A77710.8	–	10.80	0.4252	94.0	142.0	10.80
A77711.0	–	11.00	0.4331	94.0	142.0	11.00
A7777/16	7/16	11.11	0.4375	94.0	142.0	11.11
A77711.2	–	11.20	0.4409	94.0	142.0	11.20
A77711.5	–	11.50	0.4528	94.0	142.0	11.50
A77729/64	29/64	11.51	0.4531	94.0	142.0	11.51
A77711.8	–	11.80	0.4646	94.0	142.0	11.80
A77715/32	15/32	11.91	0.4688	101.0	151.0	11.91
A77712.0	–	12.00	0.4724	101.0	151.0	12.00
A77712.2	–	12.20	0.4803	101.0	151.0	12.20
A77731/64	31/64	12.30	0.4844	101.0	151.0	12.30
A77712.5	–	12.50	0.4921	101.0	151.0	12.50
A7771/2	1/2	12.70	0.5000	101.0	151.0	12.70
A77712.8	–	12.80	0.5039	101.0	151.0	12.80
A77713.0	–	13.00	0.5118	101.0	151.0	13.00
A77713.5	–	13.50	0.5315	108.0	160.0	13.50
A77714.0	–	14.00	0.5512	108.0	160.0	14.00
A77714.5	–	14.50	0.5709	114.0	169.0	14.50
A77715.0	–	15.00	0.5906	114.0	169.0	15.00
A77715.5	–	15.50	0.6102	120.0	178.0	15.50
A77716.0	–	16.00	0.6299	120.0	178.0	16.00



R457



FORCE X Solid Carbide 3XD Drill with Coolant Feed, TiAlN Coated

High performance drill, able to produce high quality and accurate holes at high speeds and feeds (H9 hole tolerance). Self centering 140°, 4-facet split point and CTW flute construction for enhanced penetration rates. Coolant holes to enhance chip evacuation. TiAlN coating increases surface hardness and improves tool life.

FORCE X

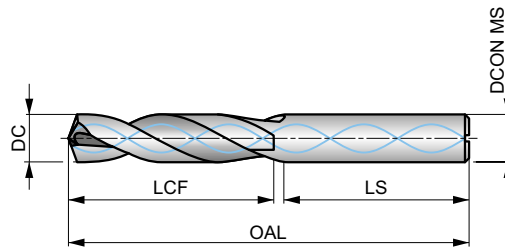

HM	DIN 6537K	3xD
140°	TiAlN	DIN 6535HA
CTW	DC m7	

Workpiece material group suitability, starting values for cutting speed (m/min) and feed Alpha Code. Tables with feed per revolution can be found starting from page XY.

P1.1 ■ 179 W	P1.2 ■ 200 W	P1.3 ■ 207 W	P2.1 ■ 153 W	P2.2 ■ 135 W	P2.3 ■ 119 V	P3.1 ■ 133 V	P3.2 ■ 107 V	P3.3 ■ 90 V	P4.1 ■ 79 V	P4.2 ■ 67 V	P4.3 ■ 55 U	M1.1 ■ 75 V	M1.2 ■ 64 V
M2.1 ■ 67 V	M2.2 ■ 55 V	M2.3 ■ 46 U	M3.1 ■ 41 V	M3.2 ■ 35 V	M3.3 ■ 32 V	M4.1 ■ 30 U	M4.2 ■ 26 U	K1.1 ■ 110 W	K1.2 ■ 81 W	K1.3 ■ 61 W	K2.1 ■ 98 V	K2.2 ■ 80 V	K2.3 ■ 64 V
K3.1 ■ 87 V	K3.2 ■ 67 V	K3.3 ■ 54 V	K4.1 ■ 81 V	K4.2 ■ 61 V	K4.3 ■ 45 V	K4.4 ■ 38 V	K4.5 ■ 32 V	K5.1 ■ 91 V	K5.2 ■ 69 V	K5.3 ■ 53 V	N1.1 ■ 250 W	N1.2 ■ 188 W	N1.3 ■ 125 W
N2.1 ■ 308 V	N2.2 ■ 277 V	N2.3 ■ 200 V	N3.1 ■ 373 W	N3.2 ■ 220 W	N3.3 ■ 110 W	S1.1 ■ 55 V	S1.2 ■ 45 V	S1.3 ■ 40 U	H1.1 ■ 56 U	H2.1 ■ 33 U	H2.2 ■ 30 U	H3.1 ■ 37 U	H3.2 ■ 30 U

DCON MS tolerance h6.

Product	DC (inch)	DC (mm)	DC (inch)	LCF (mm)	OAL (mm)	LS (mm)	DCON MS (mm)
R4573.0	—	3.00	0.1181	20.0	62.0	36.0	6.00
R4573.1	—	3.10	0.1220	20.0	62.0	36.0	6.00
R4571/8	1/8	3.18	0.1250	20.0	62.0	36.0	6.00
R4573.2	—	3.20	0.1260	20.0	62.0	36.0	6.00
R457N30	N30	3.26	0.1283	20.0	62.0	36.0	6.00
R4573.3	—	3.30	0.1299	20.0	62.0	36.0	6.00
R4573.4	—	3.40	0.1339	20.0	62.0	36.0	6.00
R457N29	N29	3.45	0.1360	20.0	62.0	36.0	6.00
R4573.5	—	3.50	0.1378	20.0	62.0	36.0	6.00
R457N28	N28	3.57	0.1406	20.0	62.0	36.0	6.00
R4579/64	9/64	3.57	0.1406	20.0	62.0	36.0	6.00
R4573.6	—	3.60	0.1417	20.0	62.0	36.0	6.00
R457N27	N27	3.66	0.1441	20.0	62.0	36.0	6.00
R4573.7	—	3.70	0.1457	20.0	62.0	36.0	6.00
R457N26	N26	3.73	0.1469	24.0	66.0	36.0	6.00
R457N25	N25	3.80	0.1496	24.0	66.0	36.0	6.00
R4573.8	—	3.80	0.1496	24.0	66.0	36.0	6.00
R457N24	N24	3.86	0.1520	24.0	66.0	36.0	6.00
R4573.9	—	3.90	0.1535	24.0	66.0	36.0	6.00
R457N23	N23	3.91	0.1539	24.0	66.0	36.0	6.00
R4575/32	5/32	3.97	0.1563	24.0	66.0	36.0	6.00
R457N22	N22	3.99	0.1571	24.0	66.0	36.0	6.00
R4574.0	—	4.00	0.1575	24.0	66.0	36.0	6.00
R457N21	N21	4.04	0.1591	24.0	66.0	36.0	6.00
R4574.05	—	4.05	0.1594	24.0	66.0	36.0	6.00



Product	DC	DC	DC	LCF	OAL	LS	DCON MS
	(inch)	(mm)	(inch)	(mm)	(mm)	(mm)	(mm)
R457N20	N20	4.09	0.1610	24.0	66.0	36.0	6.00
R4574.1	–	4.10	0.1614	24.0	66.0	36.0	6.00
R4574.2	–	4.20	0.1654	24.0	66.0	36.0	6.00
R457N19	N19	4.22	0.1661	24.0	66.0	36.0	6.00
R4574.3	–	4.30	0.1693	24.0	66.0	36.0	6.00
R457N18	N18	4.31	0.1697	24.0	66.0	36.0	6.00
R45711/64	11/64	4.37	0.1719	24.0	66.0	36.0	6.00
R457N17	N17	4.39	0.1728	24.0	66.0	36.0	6.00
R4574.4	–	4.40	0.1732	24.0	66.0	36.0	6.00
R4574.5	–	4.50	0.1772	24.0	66.0	36.0	6.00
R457N16	N16	4.50	0.1772	24.0	66.0	36.0	6.00
R457N15	N15	4.57	0.1799	24.0	66.0	36.0	6.00
R4574.6	–	4.60	0.1811	24.0	66.0	36.0	6.00
R457N14	N14	4.62	0.1819	24.0	66.0	36.0	6.00
R457N13	N13	4.70	0.1850	24.0	66.0	36.0	6.00
R4574.7	–	4.70	0.1850	24.0	66.0	36.0	6.00
R4573/16	3/16	4.76	0.1875	28.0	66.0	36.0	6.00
R4574.8	–	4.80	0.1890	28.0	66.0	36.0	6.00
R457N12	N12	4.80	0.1890	28.0	66.0	36.0	6.00
R457N11	N11	4.85	0.1909	28.0	66.0	36.0	6.00
R4574.9	–	4.90	0.1929	28.0	66.0	36.0	6.00
R457N10	N10	4.92	0.1937	28.0	66.0	36.0	6.00
R457N9	N9	4.98	0.1961	28.0	66.0	36.0	6.00
R4575.0	–	5.00	0.1969	28.0	66.0	36.0	6.00
R4575.05	–	5.05	0.1988	28.0	66.0	36.0	6.00
R457N8	N8	5.06	0.1992	28.0	66.0	36.0	6.00
R4575.1	–	5.10	0.2008	28.0	66.0	36.0	6.00
R457N7	N7	5.11	0.2010	28.0	66.0	36.0	6.00
R45713/64	13/64	5.16	0.2031	28.0	66.0	36.0	6.00
R457N6	N6	5.18	0.2039	28.0	66.0	36.0	6.00
R4575.2	–	5.20	0.2047	28.0	66.0	36.0	6.00
R457N5	N5	5.22	0.2055	28.0	66.0	36.0	6.00
R4575.3	–	5.30	0.2087	28.0	66.0	36.0	6.00
R457N4	N4	5.31	0.2091	28.0	66.0	36.0	6.00
R4575.4	–	5.40	0.2126	28.0	66.0	36.0	6.00
R457N3	N3	5.41	0.2130	28.0	66.0	36.0	6.00
R4575.5	–	5.50	0.2165	28.0	66.0	36.0	6.00
R4577/32	7/32	5.56	0.2188	28.0	66.0	36.0	6.00
R4575.6	–	5.60	0.2205	28.0	66.0	36.0	6.00
R457N2	N2	5.61	0.2209	28.0	66.0	36.0	6.00
R4575.7	–	5.70	0.2244	28.0	66.0	36.0	6.00
R457N1	N1	5.79	0.2280	28.0	66.0	36.0	6.00
R4575.8	–	5.80	0.2283	28.0	66.0	36.0	6.00
R4575.9	–	5.90	0.2323	28.0	66.0	36.0	6.00
R457A	A	5.94	0.2339	28.0	66.0	36.0	6.00
R45715/64	15/64	5.95	0.2344	28.0	66.0	36.0	6.00
R4576.0	–	6.00	0.2362	28.0	66.0	36.0	6.00
R457B	B	6.05	0.2380	34.0	79.0	36.0	8.00
R4576.05	–	6.05	0.2382	34.0	79.0	36.0	8.00
R4576.1	–	6.10	0.2402	34.0	79.0	36.0	8.00
R457C	C	6.15	0.2421	34.0	79.0	36.0	8.00
R4576.2	–	6.20	0.2441	34.0	79.0	36.0	8.00
R457D	D	6.25	0.2461	34.0	79.0	36.0	8.00
R4576.3	–	6.30	0.2480	34.0	79.0	36.0	8.00
R4571/4	1/4	6.35	0.2500	34.0	79.0	36.0	8.00
R457E	E	6.35	0.2500	34.0	79.0	36.0	8.00
R4576.4	–	6.40	0.2520	34.0	79.0	36.0	8.00
R4576.5	–	6.50	0.2559	34.0	79.0	36.0	8.00
R457F	F	6.53	0.2571	34.0	79.0	36.0	8.00
R4576.6	–	6.60	0.2598	34.0	79.0	36.0	8.00
R457G	G	6.63	0.2610	34.0	79.0	36.0	8.00
R4576.7	–	6.70	0.2638	34.0	79.0	36.0	8.00



Product	DC	DC	DC	LCF	OAL	LS	DCON MS
	(inch)	(mm)	(inch)	(mm)	(mm)	(mm)	(mm)
R45717/64	17/64	6.75	0.2656	34.0	79.0	36.0	8.00
R457H	H	6.76	0.2661	34.0	79.0	36.0	8.00
R4576.8	–	6.80	0.2677	34.0	79.0	36.0	8.00
R4576.9	–	6.90	0.2717	34.0	79.0	36.0	8.00
R457I	I	6.91	0.2720	34.0	79.0	36.0	8.00
R4577.0	–	7.00	0.2756	34.0	79.0	36.0	8.00
R457J	J	7.04	0.2772	41.0	79.0	36.0	8.00
R4577.1	–	7.10	0.2795	41.0	79.0	36.0	8.00
R457K	K	7.14	0.2811	41.0	79.0	36.0	8.00
R4579/32	9/32	7.14	0.2813	41.0	79.0	36.0	8.00
R4577.2	–	7.20	0.2835	41.0	79.0	36.0	8.00
R4577.3	–	7.30	0.2874	41.0	79.0	36.0	8.00
R457L	L	7.37	0.2902	41.0	79.0	36.0	8.00
R4577.4	–	7.40	0.2913	41.0	79.0	36.0	8.00
R457M	M	7.49	0.2949	41.0	79.0	36.0	8.00
R4577.5	–	7.50	0.2953	41.0	79.0	36.0	8.00
R45719/64	19/64	7.54	0.2969	41.0	79.0	36.0	8.00
R4577.6	–	7.60	0.2992	41.0	79.0	36.0	8.00
R457N	N	7.67	0.3020	41.0	79.0	36.0	8.00
R4577.7	–	7.70	0.3031	41.0	79.0	36.0	8.00
R4577.8	–	7.80	0.3071	41.0	79.0	36.0	8.00
R4577.9	–	7.90	0.3110	41.0	79.0	36.0	8.00
R4575/16	5/16	7.94	0.3125	41.0	79.0	36.0	8.00
R4578.0	–	8.00	0.3150	41.0	79.0	36.0	8.00
R457O	O	8.03	0.3161	47.0	89.0	40.0	10.00
R4578.05	–	8.05	0.3169	47.0	89.0	40.0	10.00
R4578.1	–	8.10	0.3189	47.0	89.0	40.0	10.00
R4578.2	–	8.20	0.3228	47.0	89.0	40.0	10.00
R457P	P	8.20	0.3228	47.0	89.0	40.0	10.00
R4578.3	–	8.30	0.3268	47.0	89.0	40.0	10.00
R45721/64	21/64	8.33	0.3281	47.0	89.0	40.0	10.00
R4578.4	–	8.40	0.3307	47.0	89.0	40.0	10.00
R457Q	Q	8.43	0.3319	47.0	89.0	40.0	10.00
R4578.5	–	8.50	0.3346	47.0	89.0	40.0	10.00
R4578.6	–	8.60	0.3386	47.0	89.0	40.0	10.00
R457R	R	8.61	0.3390	47.0	89.0	40.0	10.00
R4578.7	–	8.70	0.3425	47.0	89.0	40.0	10.00
R45711/32	11/32	8.73	0.3438	47.0	89.0	40.0	10.00
R4578.8	–	8.80	0.3465	47.0	89.0	40.0	10.00
R457S	S	8.84	0.3480	47.0	89.0	40.0	10.00
R4578.9	–	8.90	0.3504	47.0	89.0	40.0	10.00
R4579.0	–	9.00	0.3543	47.0	89.0	40.0	10.00
R457T	T	9.09	0.3579	47.0	89.0	40.0	10.00
R4579.1	–	9.10	0.3583	47.0	89.0	40.0	10.00
R45723/64	23/64	9.13	0.3594	47.0	89.0	40.0	10.00
R4579.2	–	9.20	0.3622	47.0	89.0	40.0	10.00
R4579.3	–	9.30	0.3661	47.0	89.0	40.0	10.00
R457U	U	9.35	0.3681	47.0	89.0	40.0	10.00
R4579.4	–	9.40	0.3701	47.0	89.0	40.0	10.00
R4579.5	–	9.50	0.3740	47.0	89.0	40.0	10.00
R4573/8	3/8	9.53	0.3750	47.0	89.0	40.0	10.00
R457V	V	9.58	0.3772	47.0	89.0	40.0	10.00
R4579.6	–	9.60	0.3780	47.0	89.0	40.0	10.00
R4579.7	–	9.70	0.3819	47.0	89.0	40.0	10.00
R4579.8	–	9.80	0.3858	47.0	89.0	40.0	10.00
R457W	W	9.80	0.3858	47.0	89.0	40.0	10.00
R4579.9	–	9.90	0.3898	47.0	89.0	40.0	10.00
R45725/64	25/64	9.92	0.3906	47.0	89.0	40.0	10.00
R45710.0	–	10.00	0.3937	47.0	89.0	40.0	10.00
R45710.05	–	10.05	0.3957	55.0	102.0	45.0	12.00
R457X	X	10.08	0.3969	55.0	102.0	45.0	12.00
R45710.1	–	10.10	0.3976	55.0	102.0	45.0	12.00



Product	DC	DC	DC	LCF	OAL	LS	DCON MS
	(inch)	(mm)	(inch)	(mm)	(mm)	(mm)	(mm)
R45710.2	–	10.20	0.4016	55.0	102.0	45.0	12.00
R457Y	Y	10.26	0.4039	55.0	102.0	45.0	12.00
R45710.3	–	10.30	0.4055	55.0	102.0	45.0	12.00
R45713/32	13/32	10.32	0.4063	55.0	102.0	45.0	12.00
R45710.4	–	10.40	0.4094	55.0	102.0	45.0	12.00
R457Z	Z	10.49	0.4130	55.0	102.0	45.0	12.00
R45710.5	–	10.50	0.4134	55.0	102.0	45.0	12.00
R45710.6	–	10.60	0.4173	55.0	102.0	45.0	12.00
R45727/64	27/64	10.72	0.4219	55.0	102.0	45.0	12.00
R45710.8	–	10.80	0.4252	55.0	102.0	45.0	12.00
R45711.0	–	11.00	0.4331	55.0	102.0	45.0	12.00
R4577/16	7/16	11.11	0.4375	55.0	102.0	45.0	12.00
R45711.2	–	11.20	0.4409	55.0	102.0	45.0	12.00
R45711.3	–	11.30	0.4449	55.0	102.0	45.0	12.00
R45711.4	–	11.40	0.4488	55.0	102.0	45.0	12.00
R45711.5	–	11.50	0.4528	55.0	102.0	45.0	12.00
R45729/64	29/64	11.51	0.4531	55.0	102.0	45.0	12.00
R45711.6	–	11.60	0.4567	55.0	102.0	45.0	12.00
R45711.8	–	11.80	0.4646	55.0	102.0	45.0	12.00
R45715/32	15/32	11.91	0.4688	55.0	102.0	45.0	12.00
R45712.0	–	12.00	0.4724	55.0	102.0	45.0	12.00
R45712.05	–	12.05	0.4744	60.0	107.0	45.0	14.00
R45712.1	–	12.10	0.4764	60.0	107.0	45.0	14.00
R45712.2	–	12.20	0.4803	60.0	107.0	45.0	14.00
R45731/64	31/64	12.30	0.4844	60.0	107.0	45.0	14.00
R45712.5	–	12.50	0.4921	60.0	107.0	45.0	14.00
R45712.7	–	12.70	0.5000	60.0	107.0	45.0	14.00
R4571/2	1/2	12.70	0.5000	60.0	107.0	45.0	14.00
R45712.8	–	12.80	0.5039	60.0	107.0	45.0	14.00
R45713.0	–	13.00	0.5118	60.0	107.0	45.0	14.00
R45733/64	33/64	13.10	0.5156	60.0	107.0	45.0	14.00
R45713.3	–	13.30	0.5236	60.0	107.0	45.0	14.00
R45717/32	17/32	13.49	0.5313	60.0	107.0	45.0	14.00
R45713.5	–	13.50	0.5315	60.0	107.0	45.0	14.00
R45713.8	–	13.80	0.5433	60.0	107.0	45.0	14.00
R45735/64	35/64	13.89	0.5469	60.0	107.0	45.0	14.00
R45714.0	–	14.00	0.5512	60.0	107.0	45.0	14.00
R45714.25	–	14.25	0.5610	65.0	115.0	48.0	16.00
R4579/16	9/16	14.29	0.5625	65.0	115.0	48.0	16.00
R45714.5	–	14.50	0.5709	65.0	115.0	48.0	16.00
R45737/64	37/64	14.68	0.5781	65.0	115.0	48.0	16.00
R45714.8	–	14.80	0.5827	65.0	115.0	48.0	16.00
R45715.0	–	15.00	0.5906	65.0	115.0	48.0	16.00
R45719/32	19/32	15.08	0.5938	65.0	115.0	48.0	16.00
R45715.1	–	15.10	0.5945	65.0	115.0	48.0	16.00
R45715.3	–	15.30	0.6024	65.0	115.0	48.0	16.00
R45739/64	39/64	15.48	0.6094	65.0	115.0	48.0	16.00
R45715.5	–	15.50	0.6102	65.0	115.0	48.0	16.00
R45715.8	–	15.80	0.6220	65.0	115.0	48.0	16.00
R4575/8	5/8	15.88	0.6250	65.0	115.0	48.0	16.00
R45716.0	–	16.00	0.6299	65.0	115.0	48.0	16.00
R45741/64	41/64	16.27	0.6406	73.0	123.0	48.0	18.00
R45716.5	–	16.50	0.6496	73.0	123.0	48.0	18.00
R45721/32	21/32	16.67	0.6563	73.0	123.0	48.0	18.00
R45717.0	–	17.00	0.6693	73.0	123.0	48.0	18.00
R45743/64	43/64	17.07	0.6720	73.0	123.0	48.0	18.00
R45711/16	11/16	17.46	0.6874	73.0	123.0	48.0	18.00
R45717.5	–	17.50	0.6890	73.0	123.0	48.0	18.00
R45745/64	45/64	17.86	0.7031	73.0	123.0	48.0	18.00
R45718.0	–	18.00	0.7087	73.0	123.0	48.0	18.00
R45723/32	23/32	18.26	0.7189	79.0	131.0	50.0	20.00
R45718.5	–	18.50	0.7283	79.0	131.0	50.0	20.00



Product	DC	DC	DC	LCF	OAL	LS	DCON MS
	(inch)	(mm)	(inch)	(mm)	(mm)	(mm)	(mm)
R45747/64	47/64	18.65	0.7343	79.0	131.0	50.0	20.00
R45718.8	–	18.80	0.7402	79.0	131.0	50.0	20.00
R45719.0	–	19.00	0.7480	79.0	131.0	50.0	20.00
R4573/4	3/4	19.05	0.7500	79.0	131.0	50.0	20.00
R45719.5	–	19.50	0.7677	79.0	131.0	50.0	20.00
R45719.8	–	19.80	0.7795	79.0	131.0	50.0	20.00
R45720.0	–	20.00	0.7874	79.0	131.0	50.0	20.00



DRILLING FEED RATE CHART

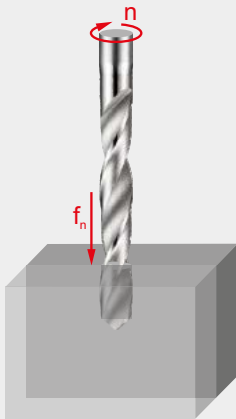

Feed per revolution (f_n in mm/rev)
Depending on the working conditions
it might be necessary to adjust these
values $\pm 25\%$.

How to use this table to find the feed per revolution (f_n):

1. Find your Alpha Code on the product page (example: 46J, "J" is the Alpha Code).
2. Find the closest diameter for your cutting application in the top row of the table.
3. Find your Alpha Code in the left column of the table.
4. The intersection (cell) of the Diameter and Alpha Code is the feed per revolution (f_n).

		\varnothing DC (mm)																		
		0.15	0.50	1.00	2.00	3.00	4.00	5.00	6.00	8.00	10.00	12.00	15.00	16.00	20.00	25.00	30.00	40.00	50.00	100.00
Feed rates	A	0.003	0.006	0.012	0.023	0.029	0.032	0.036	0.042	0.054	0.062	0.069	0.082	0.086	0.110	0.125	0.135	0.155	0.175	0.263
	B	0.004	0.007	0.014	0.028	0.037	0.041	0.046	0.053	0.067	0.080	0.090	0.103	0.108	0.135	0.153	0.165	0.188	0.208	0.312
	C	0.004	0.008	0.015	0.032	0.044	0.050	0.056	0.064	0.080	0.098	0.110	0.125	0.130	0.160	0.180	0.195	0.220	0.240	0.360
	D	0.004	0.008	0.016	0.038	0.053	0.060	0.068	0.078	0.098	0.119	0.130	0.149	0.155	0.188	0.210	0.228	0.253	0.275	0.413
	E	0.004	0.009	0.017	0.043	0.062	0.071	0.080	0.092	0.115	0.140	0.150	0.173	0.180	0.215	0.240	0.260	0.285	0.310	0.465
	F	0.005	0.009	0.018	0.050	0.073	0.084	0.095	0.109	0.138	0.165	0.178	0.202	0.210	0.248	0.275	0.295	0.320	0.343	0.515
	G	0.005	0.010	0.019	0.056	0.084	0.096	0.109	0.126	0.160	0.190	0.205	0.231	0.240	0.280	0.310	0.330	0.355	0.375	0.563
	H	0.005	0.010	0.020	0.066	0.102	0.116	0.130	0.150	0.190	0.228	0.243	0.271	0.280	0.320	0.355	0.375	0.398	0.418	0.627
	I	0.005	0.011	0.021	0.076	0.119	0.134	0.150	0.173	0.220	0.265	0.280	0.310	0.320	0.360	0.400	0.420	0.440	0.460	0.690
	J	0.006	0.012	0.024	0.084	0.135	0.152	0.170	0.197	0.250	0.298	0.315	0.349	0.360	0.405	0.445	0.465	0.485	0.503	0.755
	K	0.007	0.013	0.026	0.092	0.150	0.170	0.190	0.220	0.280	0.330	0.350	0.388	0.400	0.450	0.490	0.510	0.530	0.545	0.818
	L	0.007	0.014	0.028	0.101	0.165	0.186	0.208	0.240	0.305	0.360	0.385	0.419	0.430	0.485	0.525	0.545	0.568	0.588	0.882
	M	0.008	0.015	0.030	0.110	0.180	0.202	0.225	0.260	0.330	0.390	0.420	0.450	0.460	0.520	0.560	0.580	0.605	0.630	0.945
	N	0.008	0.016	0.032	0.119	0.195	0.218	0.242	0.280	0.355	0.420	0.455	0.481	0.490	0.555	0.595	0.615	0.642	0.672	1.008
	S	0.002	0.004	0.008	0.014	0.020	0.025	0.030	0.037	0.050	0.080	0.100	0.123	0.130	0.150	0.170	0.190	0.220	0.240	–
	T	0.004	0.008	0.015	0.028	0.040	0.050	0.060	0.070	0.090	0.110	0.130	0.160	0.170	0.190	0.210	0.230	0.260	0.275	–
	U	0.007	0.013	0.026	0.048	0.070	0.080	0.090	0.107	0.140	0.170	0.200	0.223	0.230	0.240	0.270	0.300	0.360	0.375	–
	V	0.010	0.019	0.038	0.069	0.100	0.115	0.130	0.153	0.200	0.250	0.280	0.310	0.320	0.340	0.400	0.440	0.510	0.530	–
	W	0.012	0.025	0.049	0.089	0.130	0.150	0.170	0.200	0.260	0.330	0.380	0.418	0.430	0.450	0.470	0.490	0.520	0.540	–
	X	0.014	0.028	0.056	0.103	0.150	0.180	0.210	0.250	0.330	0.420	0.480	0.533	0.550	0.580	–	–	–	–	–
Y	0.017	0.034	0.068	0.124	0.180	0.220	0.260	0.317	0.430	0.550	0.700	0.700	0.700	0.740	–	–	–	–	–	
Z	0.024	0.047	0.094	0.172	0.250	0.325	0.400	0.533	0.800	1.000	1.100	1.175	1.200	1.200	–	–	–	–	–	



REAMERS & COUNTERSINKS



REAMERS AND COUNTERSINKS – PAGE OVERVIEW

1 B400

DORMER



Carbide Straight Shank Machine Reamer with H7 Accuracy, Bright Finish

Designed to provide a finish within the limits of H7 hole tolerance. For superior performance and extended tool life when reaming hard and abrasive materials. The spiral flute design, with extremely unequal spacing between the flutes, reduces vibration and improves hole roundness, size and surface finish.

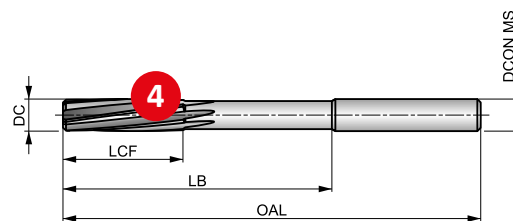

HM	Bright	DIN 8093
R	B	
H7		

Workpiece material group suitability, starting values for cutting speed (m/min) and feed Alpha Code. Tables with feed per revolution can be found starting from page 251.

P1.1	P1.2	P1.3	P2.1	P2.2	P2.3	P3.1	P3.2	P3.3	P4.1	P4.2	P4.3	M1.1	M1.2
■ 23 B	■ 26 B	■ 27 B	■ 20 B	■ 18 B	■ 16 C	■ 16 B	■ 13 B	■ 11 C	■ 10 B	■ 8 C	■ 7 C	■ 10 C	■ 8 C
M2.1	M2.2	M2.3	K1.1	K1.2	K1.3	K2.1	K2.2	K2.3	K3.1	K3.2	K3.3	K5.1	K5.2
■ 9 C	■ 7 C	■ 6 B	■ 20 D	■ 15 D	■ 11 D	■ 2	■ 17 D	■ 14 D	■ 18 D	■ 14 D	■ 11 D	■ 19 D	■ 15 D
K5.3	N1.1	N1.2	N1.3	N2.1	N2.2	N2.3	N3.1	N3.2	N3.3	N4.1	N4.2		
■ 11 D	■ 60 D	■ 45 D	■ 30 D	■ 38 D	■ 35 D	■ 25 D	■ 64 E	■ 38 E	■ 19 E	■ 35 C	■ 30 C		

DCON MS tolerance h6; DC= 14 mm Carbide Tipped.

Product	DC	OAL	LCF	LB	NOF	DCON MS
	[mm]	[mm]	[mm]	[mm]		[mm]
B4001.0	1.00	34.0	5.5	15.00	3	1.00
B4001.2	1.20	38.0	7.5	16.50	3	1.20
B4001.4	1.40	40.0	8.0	18.00	3	1.50
B4001.5	1.50	40.0	8.0	18.00	3	1.50
B4001.6	1.60	43.0	9.0	20.00	3	1.60
B4001.8	1.80	46.0	10.0	22.00	4	1.80
B4002.0	2.00	49.0	11.0	24.00	4	2.00
B4002.2	2.20	53.0	12.0	25.00	4	2.20
B4002.5	2.50	57.0	14.0	30.00	4	2.50
B4003.0	2.80	61.0	15.0	33.00	6	3.00
B4003.0	3.00	61.0	15.0	33.00	6	3.00
B4003.2	3.20	65.0	16.0	37.00	6	3.20

Product	DC	OAL	LCF	LB	NOF	DCON MS
	[mm]	[mm]	[mm]	[mm]		[mm]
B4004.5	4.50	80.0	21.0	52.00	6	4.50
B4005.0	5.00	86.0	23.0	58.00	6	5.00
B4005.5	5.50	93.0	26.0	57.00	6	5.60
B4006.0	6.00	93.0	26.0	57.00	6	5.60
B4006.5	6.50	101.0	28.0	65.00	6	6.30
B4007.0	7.00	109.0	31.0	73.00	6	7.10
B4008.0	8.00	117.0	33.0	81.00	6	8.00
B4009.0	9.00	125.0	36.0	85.00	6	9.00
B40010.0	10.00	133.0	38.0	93.00	6	10.00
B40012.0	12.00	151.0	44.0	111.00	6	10.00
B40014.0	14.00	160.0	47.0	115.00	6	12.50
B40016.0	16.00	170.0	52.0	125.00	6	12.50

Pos.	Description
1	Designation of drill
2	Product description
3	Illustrative picture
4	Schematic drawing of tool

Pos.	Description
5	Product features
6	Material group recommendations incl. speed and feed guidance
7	Product code
8	Product dimensions

Typical page with reamers/countersinks displayed – specific page details will differ.



REAMERS AND COUNTERSINKS – ICONS OVERVIEW

GENERAL ICONS

	Primary use
	Possible use

ACHIEVABLE HOLE TOLERANCE ZONE (TCHA)

	H7 – Industry Standard Hole Tolerance Zone (based on diameter range)		k11 – Industry Standard Tool Tolerance Zone (based on diameter range)
	High Precision Hole Tolerance Zone (based on diameter range)		

Application Angle

	100° Countersink		20° Conical Drill		82° Countersink
	180° Counterbore		60° Countersink		90° Countersink

BASIC STANDARD GROUP (BSG)

	ANSI – Tap Standards		DIN 219 – Shell Reamer Standards		DIN 8050 – Parallel Shank Reamer Standards
	BS 328 – Drills and Reamers Standards		DIN 311 – Morse Taper Shank Bridge Reamer Standards		DIN 8051 – Morse Taper Shank Reamer Standards
	DIN 206 – Hand Reamer Standards		DIN 334 C – Straight Shank Countersink Standards		DIN 8093 – Straight Shank Reamer Standards
	DIN 208 – Morse Taper Shank Chucking Reamer Standards		DIN 334 D – Morse Taper Shank Countersink Standards		DIN 8094 – Morse Taper Shank Reamer Standards
	DIN 212 – Machine Reamer Standards		DIN 335 A – Straight Shank Countersink Standards		DIN 9 – Taper Pin Reamer Standards
	DIN 217 – Shell Reamer Arbor Standards		DIN 335 C – Straight Shank Countersink Standards		Dormer Standards
	DIN 2179 – Parallel Shank Taper Pin Reamer Standards		DIN 335 D – Morse Taper Shank Countersink Standards		
	DIN 2180 – Morse Taper Shank Taper Pin Reamer Standards		DIN 373 – Counterbore Standards		

COATING

	Aluminium Titanium Carbon Nitride Coating		Combination Bright and Steam Oxide		Titanium Aluminium Nitride Coating
	Bright (uncoated)		Steam and Bronze Oxide Surface Treatment		Titanium Nitride Coated

CUTTING DIRECTION

	Right Hand Rotation / Cutting
--	-------------------------------

MATERIAL CODE (BMC)

	Hard Material (Solid Carbide)		High Speed Steel Tool Material
	High Speed Cobalt Steel Tool Material		









REAMERS AND COUNTERSINKS – ICONS OVERVIEW

REAMER FORM

A	DIN Form A – Straight Flute $\leq \varnothing 3.5\text{mm}$
B	DIN Form B – Spiral Flute $\leq \varnothing 3.5\text{mm}$
E	DIN Form C – Straight Flute $\geq \varnothing 4.0\text{mm}$

SHANK

	Cylindrical Shank / Straight Shank		Cylindrical Shank with Tang
	Cylindrical Shank with 3flat		DIN 6535 HA Cylindrical Shank
	Cylindrical Shank with Hex		Morse Taper Shank
	Cylindrical Shank with Square		



TAPER GRADIENT (RATE OF TAPER)

	1:48 Taper Gradient (1/4" per foot taper)		1:50 Taper Gradient (1 mm per 50 mm taper)
---	---	---	--



REAMERS AND COUNTERSINKS – NAVIGATOR TOOL MATERIALS







Tool materials

High Speed Steel		<p>A medium-alloyed high speed steel that has good machinability and good performance. HSS exhibits hardness, toughness and wear resistance characteristics that make it attractive in a wide range of applications, for example in drills and taps.</p>
Cobalt High Speed Steel		<p>This high speed steel contains cobalt for increased hot hardness. The composition of HSS-Co is a good combination of toughness and hardness. It has good machinability and good wear resistance, which makes it usable for drills, taps, milling cutters and reamers.</p>

Carbide materials

Carbide Materials (or Hard Materials)		<p>A sintered powder metallurgy substrate, consisting of a metallic carbide composite with binder metal. The most central raw material is tungsten carbide (WC). Tungsten carbide contributes to the hardness of the material. Tantalum carbide (TaC), titanium carbide (TiC) and niobium carbide (NbC) complements WC and adjusts the properties to what is desired. These three materials are called cubic carbides. Cobalt (Co) acts as a binder and keeps the material together.</p> <p>Carbide materials are often characterised by high compression strength, high hardness and therefore high wear resistance, but also by limited flexural strength and toughness. Carbide is used in taps, reamers, milling cutters, drills and thread milling cutters.</p>
--	---	--

Surface Coatings

Titanium Nitride (TiN)		<p>Titanium Nitride is a gold coloured ceramic coating applied by physical vapour deposition (PVD). High hardness combined with low friction properties ensures considerably longer tool life, or alternatively, better cutting performance from tools which have not been coated. TiN coating is used mainly for drills and taps.</p>
Aluminium Titanium Carbon Nitride (AlTiCN)		<p>Aluminium Titanium Carbon-Nitride (AlTiCN) is a PVD coating which was specifically engineered to meet the rigorous requirements of the medical device industry. It is however equally applicable to certain cutting tool operations due to a high quality thin-film technology, with excellent micro-hardness and adhesion characteristics.</p>
Titanium Aluminium Nitride coatings (TiAlN)		<p>Titanium Aluminium Nitride is a multi layer ceramic coating applied by PVD coating technology, which exhibits high toughness and oxidation stability. These properties make it ideal for higher speeds and feeds, while at the same time improving tool life. TiAlN is used in drilling, tapping, and milling applications and can be suitable for use when machining without coolant.</p>
Bright (uncoated)		<p>Bright finish (uncoated surface) improves chip flow in soft or non-ferrous materials while maintaining sharp cutting edges.</p>
Combination Bright and Steam Tempered		<p>Combination of bright and steam tempering can be effective, as the blue oxide more porous surface acts to retain and pull cutting fluid into the hole while the bright surface assists in chip evacuation. This combination is achieved by grinding the bright surface after tempering.</p>
Combination Steam and Bronze Tempered Surface Treatment		<p>Combination of steam and bronze tempering can be effective, as the blue oxide more porous surface acts to retain and pull cutting fluid into the hole while the bronze surface assists in chip evacuation. Both surface treatments add a degree of surface protection to the tool. These combinations are achieved by using two different tempering cycles.</p>



		HSS	HSS-E	HSS-E	HM	HM	HSS-E	HSS-E	HSS-E	HSS								
Material code (BMC)		HSS	HSS-E	HSS-E	HM	HM	HSS-E	HSS-E	HSS-E	HSS								
Coating		Bright ST	Bright	Bright	Bright	Bright	Bright ST	Bright	AlTiCN	Bright								
Basic standard group (BSG)		DIN 206	DIN 208	DIN 212	DIN 8093	DIN 8094	DIN 219	DIN 217	DIN 335C	DIN 335D								
Hand (Cutting direction)		R	R	R	R	R	R		R	R								
Shank																		
Application angle									90°	90°								
Reamer form		B	B	B	B	B	B											
Achievable hole tolerance (TCHA)		H7	H7	H7	H7	H7	H7											
Taper gradient - millimeter (Rate of taper)																		
Product Family Code		B100	B161	B180	B400	B411	B955	B956	G570	G138								
		1.50 - 50.00	3.00 - 50.00	1.50 - 20.00	1.00 - 20.00	5.00 - 30.00	25.00 - 80.00	13.00 - 40.00	6.30 - 31.00	25.00 - 80.00								
		462	464	465	467	468	469	470	472	471								
P	P1	■	■	■	■	■	■		■	■								
	P2	■	■	■	■	■	■		■	■								
	P3	■	■	■	■	■	■		■	■								
	P4	■	■	■	■	■	■	■	■	■								
M	M1	■	■	■	■	■	■		■	■								
	M2	■	■	■	■	■	■		■	■								
	M3								■	■								
	M4								■	■								
K	K1	■	■	■	■	■	■		■	■								
	K2	■	■	■	■	■	■		■	■								
	K3	■	■	■	■	■	■	■	■	■								
	K4								■	■								
	K5				■	■			■	■								
N	N1	■	■	■	■	■	■		■	■								
	N2	■	■	■	■	■	■		■	■								
	N3	■	■	■	■	■	■		■	■								
	N4	■	■	■	■	■	■	■	■	■								
	N5								■	■								
S	S1																	
	S2																	
	S3																	
	S4																	
H	H1																	
	H2																	
	H3																	
	H4																	



B100



HSS Straight Shank Hand Reamer with H7 Accuracy, Bright and ST Finish

Primarily designed for reaming by hand. It has a precision ground, left-hand helix with right-hand (clockwise) cutting for smooth reaming, creating a more accurate hole size and good surface finish. Suitable for reaming many materials, including steels.

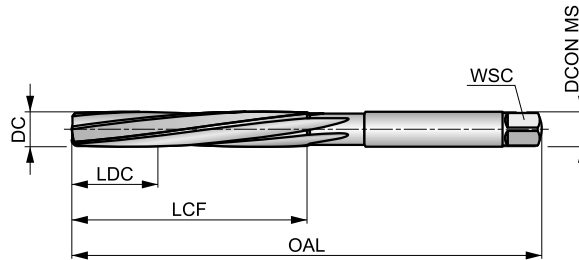

HSS	Bright ST	DIN 206
R		B
H7		

Workpiece material group suitability.

P1.1	P1.2	P1.3	P2.1	P2.2	P2.3	P3.1	P3.2	P3.3	P4.1	P4.2	P4.3	M1.1	M1.2
■	■	■	■	■	■	■	■	■	■	■	■	■	■
M2.1	K1.1	K1.2	K1.3	K2.1	K2.2	K2.3	K3.1	K3.2	N1.1	N1.2	N1.3	N2.1	N2.2
■	■	■	■	■	■	■	■	■	■	■	■	■	■
N2.3	N3.1	N3.2	N3.3	N4.1	N4.2								
■	■	■	■	■	■								

DCON MS tolerance e9.

Product	DC (inch)	DC (mm)	OAL (mm)	LCF (mm)	LDC (mm)	NOF	WSC (mm)	DCON MS (mm)
B1001.5	–	1.50	41.0	20.0	5.00	3	1.12	1.50
B1001/16	1/16	1.59	41.0	20.0	5.00	3	1.12	1.59
B1001.6	–	1.60	44.0	21.0	5.00	3	1.25	1.60
B1005/64	5/64	1.98	47.0	23.0	6.00	4	1.40	1.98
B1002.0	–	2.00	50.0	25.0	6.00	4	1.60	2.00
B1003/32	3/32	2.38	54.0	27.0	7.00	4	1.80	2.38
B1002.5	–	2.50	58.0	29.0	7.00	4	2.10	2.50
B1007/64	7/64	2.78	62.0	31.0	8.00	6	2.10	2.78
B1003.0	–	3.00	62.0	31.0	8.00	6	2.40	3.00
B1001/8	1/8	3.18	66.0	33.0	8.00	6	2.40	3.18
B1003.2	–	3.20	66.0	33.0	8.00	6	2.40	3.20
B1003.5	–	3.50	71.0	35.0	9.00	6	2.70	3.50
B1009/64	9/64	3.57	71.0	35.0	9.00	6	2.70	3.57
B1005/32	5/32	3.97	76.0	38.0	10.00	6	3.00	3.97
B1004.0	–	4.00	76.0	38.0	10.00	6	3.00	4.00
B10011/64	11/64	4.37	81.0	41.0	10.00	6	3.40	4.37
B1004.5	–	4.50	81.0	41.0	10.00	6	3.40	4.50
B1003/16	3/16	4.76	87.0	44.0	11.00	6	3.80	4.76
B1005.0	–	5.00	87.0	44.0	11.00	6	3.80	5.00
B10013/64	13/64	5.16	87.0	44.0	11.00	6	3.80	5.16
B1005.5	–	5.50	93.0	47.0	12.00	6	4.30	5.50
B1007/32	7/32	5.56	93.0	47.0	12.00	6	4.30	5.56
B10015/64	15/64	5.95	93.0	47.0	12.00	6	4.90	5.95
B1006.0	–	6.00	93.0	47.0	12.00	6	4.90	6.00
B1001/4	1/4	6.35	100.0	50.0	13.00	6	4.90	6.35
B1006.5	–	6.50	100.0	50.0	13.00	6	4.90	6.50
B10017/64	17/64	6.75	107.0	54.0	14.00	6	5.50	6.75



Product	DC	DC	OAL	LCF	LDC	NOF	WSC	DCON MS
	(inch)	(mm)	(mm)	(mm)	(mm)		(mm)	(mm)
B1007.0	–	7.00	107.0	54.0	14.00	6	5.50	7.00
B1009/32	9/32	7.14	107.0	54.0	14.00	6	6.20	7.14
B1007.5	–	7.50	107.0	54.0	14.00	6	6.20	7.50
B10019/64	19/64	7.54	115.0	58.0	15.00	6	6.20	7.54
B1005/16	5/16	7.94	115.0	58.0	15.00	6	6.20	7.94
B1008.0	–	8.00	115.0	58.0	15.00	6	6.20	8.00
B10021/64	21/64	8.33	115.0	58.0	15.00	6	7.00	8.33
B1008.5	–	8.50	115.0	58.0	15.00	6	7.00	8.50
B10011/32	11/32	8.73	124.0	62.0	16.00	6	7.00	8.73
B1009.0	–	9.00	124.0	62.0	16.00	6	7.00	9.00
B10023/64	23/64	9.13	124.0	62.0	16.00	6	8.00	9.13
B1009.5	–	9.50	124.0	62.0	16.00	6	8.00	9.50
B1003/8	3/8	9.52	124.0	62.0	17.00	6	8.00	9.52
B10025/64	25/64	9.92	133.0	66.0	17.00	6	8.00	9.92
B10010.0	–	10.00	133.0	66.0	17.00	6	8.00	10.00
B10013/32	13/32	10.32	133.0	66.0	17.00	6	8.00	10.32
B10010.5	–	10.50	133.0	66.0	17.00	6	8.00	10.50
B10011.0	–	11.00	142.0	71.0	18.00	6	9.00	11.00
B1007/16	7/16	11.11	142.0	71.0	18.00	6	9.00	11.11
B10011.5	–	11.50	142.0	71.0	18.00	6	9.00	11.50
B10012.0	–	12.00	152.0	76.0	19.00	6	9.00	12.00
B10012.5	–	12.50	152.0	76.0	19.00	6	10.00	12.50
B1001/2	1/2	12.70	152.0	76.0	19.00	6	10.00	12.70
B10013.0	–	13.00	152.0	76.0	19.00	6	10.00	13.00
B10017/32	17/32	13.49	163.0	81.0	20.00	8	11.00	13.49
B10013.5	–	13.50	163.0	81.0	20.00	8	11.00	13.50
B10014.0	–	14.00	163.0	81.0	20.00	8	11.00	14.00
B1009/16	9/16	14.29	163.0	81.0	20.00	8	11.00	14.29
B10014.5	–	14.50	163.0	81.0	20.00	8	11.00	14.50
B10015.0	–	15.00	163.0	81.0	20.00	8	12.00	15.00
B10019/32	19/32	15.08	163.0	81.0	22.00	8	12.00	15.08
B1005/8	5/8	15.88	175.0	87.0	22.00	8	12.00	15.88
B10016.0	–	16.00	175.0	87.0	22.00	8	12.00	16.00
B10017.0	–	17.00	175.0	87.0	22.00	8	13.00	17.00
B10011/16	11/16	17.46	188.0	93.0	23.00	8	14.50	17.46
B10018.0	–	18.00	188.0	93.0	23.00	8	14.50	18.00
B10019.0	–	19.00	188.0	93.0	23.00	8	14.50	19.00
B1003/4	3/4	19.05	188.0	93.0	25.00	8	14.50	19.05
B10020.0	–	20.00	201.0	100.0	25.00	8	16.00	20.00
B10013/16	13/16	20.64	201.0	100.0	25.00	8	16.00	20.64
B10021.0	–	21.00	201.0	100.0	25.00	8	16.00	21.00
B10022.0	–	22.00	215.0	107.0	27.00	8	18.00	22.00
B1007/8	7/8	22.22	215.0	107.0	27.00	8	18.00	22.22
B10023.0	–	23.00	215.0	107.0	27.00	8	18.00	23.00
B10024.0	–	24.00	231.0	115.0	29.00	8	18.00	24.00
B10025.0	–	25.00	231.0	115.0	29.00	8	20.00	25.00
B1001	1"	25.40	231.0	115.0	29.00	8	20.00	25.40
B10026.0	–	26.00	231.0	115.0	29.00	8	20.00	26.00
B10027.0	–	27.00	247.0	124.0	31.00	10	22.00	27.00
B10028.0	–	28.00	247.0	124.0	31.00	10	22.00	28.00
B10029.0	–	29.00	247.0	124.0	31.00	10	22.00	29.00
B10030.0	–	30.00	247.0	124.0	31.00	10	24.00	30.00
B10031.0	–	31.00	265.0	133.0	33.00	10	24.00	31.00
B10032.0	–	32.00	265.0	133.0	33.00	10	24.00	32.00
B10033.0	–	33.00	265.0	133.0	33.00	10	26.00	33.00
B10034.0	–	34.00	284.0	142.0	36.00	10	26.00	34.00
B10035.0	–	35.00	284.0	142.0	36.00	10	29.00	35.00
B10036.0	–	36.00	284.0	142.0	36.00	10	29.00	36.00
B10037.0	–	37.00	284.0	142.0	36.00	10	29.00	37.00
B10038.0	–	38.00	305.0	152.0	38.00	10	29.00	38.00
B10039.0	–	39.00	305.0	152.0	38.00	10	32.00	39.00
B10040.0	–	40.00	305.0	152.0	38.00	10	32.00	40.00
B10045.0	–	45.00	326.0	163.0	41.00	12	35.00	45.00
B10050.0	–	50.00	347.0	174.0	44.00	12	39.00	50.00



B161



HSS-E Taper Shank Machine Reamer with H7 Accuracy, Bright Finish

The precision ground left-hand helix and right-hand cutting action, ensures smooth reaming and improved surface finish and hole size. Suitable for reaming in many materials.

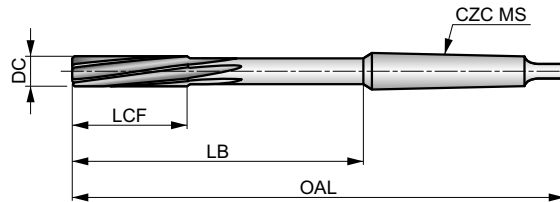

HSS-E	Bright	DIN 208
R		B
H7		

Workpiece material group suitability, starting values for cutting speed (m/min) and feed Alpha Code. Tables with feed per revolution can be found starting from page XY.

P1.1 ■ 21 C	P1.2 ■ 24 C	P1.3 ■ 25 C	P2.1 ■ 18 C	P2.2 ■ 16 C	P2.3 ▣ 14 B	P3.1 ■ 13 B	P3.2 ■ 11 B	P3.3 ▣ 9 B	P4.1 ■ 8 B	P4.2 ▣ 7 B	P4.3 ▣ 5 A	M1.1 ▣ 11 C	M1.2 ▣ 10 B
M2.1 ▣ 9 B	K1.1 ■ 16 E	K1.2 ■ 12 D	K1.3 ▣ 9 D	K2.1 ■ 16 C	K2.2 ■ 13 C	K2.3 ▣ 10 C	K3.1 ■ 14 C	K3.2 ▣ 11 C	N1.1 ▣ 24 F	N1.2 ■ 18 F	N1.3 ■ 11 F	N2.1 ▣ 27 E	N2.2 ■ 24 E
N2.3 ■ 16 E	N3.1 ■ 47 D	N3.2 ■ 28 E	N3.3 ▣ 14 D	N4.1 ▣ 30 B									

Product	DC (mm)	OAL (mm)	LCF (mm)	LB (mm)	NOF	CZC MS
B1613.0	3.00	113.0	15.0	47.50	6	MK 1
B1614.0	4.00	124.0	19.0	58.50	6	MK 1
B1615.0	5.00	133.0	23.0	67.50	6	MK 1
B1616.0	6.00	138.0	26.0	72.50	6	MK 1
B1617.0	7.00	150.0	31.0	84.50	6	MK 1
B1618.0	8.00	156.0	33.0	90.50	6	MK 1
B1619.0	9.00	162.0	36.0	96.50	6	MK 1
B16110.0	10.00	168.0	38.0	102.50	6	MK 1
B16111.0	11.00	175.0	41.0	109.50	6	MK 1
B16112.0	12.00	182.0	44.0	116.50	6	MK 1
B16113.0	13.00	182.0	44.0	116.50	6	MK 1
B16114.0	14.00	189.0	47.0	123.50	8	MK 1
B16115.0	15.00	204.0	50.0	124.00	8	MK 2
B16116.0	16.00	210.0	52.0	130.00	8	MK 2
B16117.0	17.00	214.0	54.0	134.00	8	MK 2
B16118.0	18.00	219.0	56.0	139.00	8	MK 2
B16119.0	19.00	223.0	58.0	143.00	8	MK 2
B16120.0	20.00	228.0	60.0	148.00	8	MK 2
B16121.0	21.00	232.0	62.0	152.00	8	MK 2
B16122.0	22.00	237.0	64.0	157.00	8	MK 2
B16123.0	23.00	241.0	66.0	161.00	8	MK 2
B16124.0	24.00	268.0	68.0	169.00	8	MK 3

Product	DC (mm)	OAL (mm)	LCF (mm)	LB (mm)	NOF	CZC MS
B16125.0	25.00	268.0	68.0	169.00	8	MK 3
B16126.0	26.00	273.0	70.0	174.00	8	MK 3
B16127.0	27.00	277.0	71.0	178.00	10	MK 3
B16128.0	28.00	277.0	71.0	178.00	10	MK 3
B16129.0	29.00	281.0	73.0	182.00	10	MK 3
B16130.0	30.00	281.0	73.0	182.00	10	MK 3
B16131.0	31.00	285.0	75.0	186.00	10	MK 3
B16132.0	32.00	317.0	77.0	193.00	10	MK 4
B16133.0	33.00	317.0	77.0	193.00	10	MK 4
B16134.0	34.00	321.0	78.0	197.00	10	MK 4
B16135.0	35.00	321.0	78.0	197.00	10	MK 4
B16136.0	36.00	325.0	79.0	201.00	10	MK 4
B16138.0	38.00	329.0	81.0	205.00	10	MK 4
B16140.0	40.00	329.0	81.0	205.00	10	MK 4
B16142.0	42.00	333.0	82.0	209.00	12	MK 4
B16144.0	44.00	336.0	83.0	212.00	12	MK 4
B16145.0	45.00	336.0	83.0	212.00	12	MK 4
B16146.0	46.00	340.0	84.0	216.00	12	MK 4
B16147.0	47.00	340.0	84.0	216.00	12	MK 4
B16148.0	48.00	344.0	86.0	220.00	12	MK 4
B16150.0	50.00	344.0	86.0	220.00	12	MK 4



B180



HSS-E Straight Shank Machine Reamer with H7 Accuracy, Bright Finish

High performance reamer for CNC machines and held in high accuracy tool holders or chucks. The precision ground left-hand helix and right-hand cutting action ensures smooth reaming and improved surface finish and hole size. Suitable for reaming in many materials.

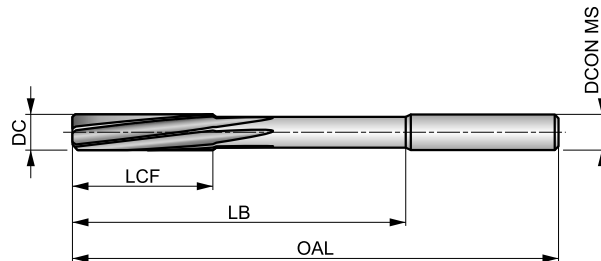

HSS-E	Bright	DIN 212
R	DIN 6535HA	B
H7		

Workpiece material group suitability, starting values for cutting speed (m/min) and feed Alpha Code. Tables with feed per revolution can be found starting from page XY.

P1.1 ■ 21 C	P1.2 ■ 24 C	P1.3 ■ 25 C	P2.1 ■ 18 C	P2.2 ■ 16 C	P2.3 ■ 14 B	P3.1 ■ 13 B	P3.2 ■ 11 B	P3.3 ■ 9 B	P4.1 ■ 8 B	P4.2 ■ 7 B	P4.3 ■ 5 A	M1.1 ■ 11 C	M1.2 ■ 10 B
M2.1 ■ 9 B	K1.1 ■ 16 E	K1.2 ■ 12 D	K1.3 ■ 9 D	K2.1 ■ 16 C	K2.2 ■ 13 C	K2.3 ■ 10 C	K3.1 ■ 14 C	K3.2 ■ 11 C	N1.1 ■ 24 F	N1.2 ■ 18 F	N1.3 ■ 11 F	N2.1 ■ 27 E	N2.2 ■ 24 E
N2.3 ■ 16 E	N3.1 ■ 47 D	N3.2 ■ 28 E	N3.3 ■ 14 D	N4.1 ■ 30 B									

DCON MS tolerance h6.

Product	DC (mm)	OAL (mm)	LCF (mm)	LB (mm)	NOF	DCON MS (mm)
B1801.5	1.50	40.0	8.0	18.00	3	2.00
B1801.6	1.60	43.0	9.0	20.00	3	2.00
B1801.7	1.70	43.0	9.0	20.00	3	2.00
B1801.8	1.80	46.0	10.0	22.00	4	2.00
B1801.9	1.90	46.0	10.0	22.00	4	2.00
B1802.0	2.00	49.0	11.0	24.00	4	2.00
B1802.1	2.10	49.0	11.0	24.00	4	2.00
B1802.2	2.20	53.0	12.0	26.00	4	3.00
B1802.3	2.30	53.0	12.0	26.00	4	3.00
B1802.4	2.40	57.0	14.0	28.00	4	3.00
B1802.5	2.50	57.0	14.0	28.00	4	3.00
B1802.6	2.60	57.0	14.0	28.00	4	3.00
B1802.7	2.70	61.0	15.0	32.00	6	3.00
B1802.8	2.80	61.0	15.0	32.00	6	3.00
B1802.9	2.90	61.0	15.0	32.00	6	3.00
B1803.0	3.00	61.0	15.0	32.00	6	3.00
B1803.1	3.10	65.0	16.0	35.00	6	4.00
B1803.2	3.20	65.0	16.0	35.00	6	4.00
B1803.3	3.30	65.0	16.0	35.00	6	4.00
B1803.4	3.40	70.0	18.0	40.00	6	4.00
B1803.5	3.50	70.0	18.0	40.00	6	4.00
B1803.6	3.60	70.0	18.0	40.00	6	4.00
B1803.7	3.70	70.0	18.0	40.00	6	4.00
B1803.8	3.80	75.0	19.0	43.00	6	4.00
B1803.9	3.90	75.0	19.0	43.00	6	4.00
B1804.0	4.00	75.0	19.0	43.00	6	4.00
B1804.1	4.10	75.0	19.0	43.00	6	4.00
B1804.2	4.20	75.0	19.0	43.00	6	4.00
B1804.3	4.30	80.0	21.0	47.00	6	5.00
B1804.4	4.40	80.0	21.0	47.00	6	5.00
B1804.5	4.50	80.0	21.0	47.00	6	5.00
B1804.6	4.60	80.0	21.0	47.00	6	5.00
B1804.7	4.70	80.0	21.0	47.00	6	5.00
B1804.8	4.80	86.0	23.0	52.00	6	5.00
B1804.9	4.90	86.0	23.0	52.00	6	5.00
B1805.0	5.00	86.0	23.0	52.00	6	5.00
B1805.1	5.10	86.0	23.0	52.00	6	5.00
B1805.2	5.20	86.0	23.0	52.00	6	5.00
B1805.3	5.30	86.0	23.0	52.00	6	5.00
B1805.4	5.40	93.0	26.0	57.00	6	6.00
B1805.5	5.50	93.0	26.0	57.00	6	6.00
B1805.6	5.60	93.0	26.0	57.00	6	6.00
B1805.7	5.70	93.0	26.0	57.00	6	6.00
B1805.8	5.80	93.0	26.0	57.00	6	6.00
B1805.9	5.90	93.0	26.0	57.00	6	6.00
B1806.0	6.00	93.0	26.0	57.00	6	6.00
B1806.1	6.10	101.0	28.0	63.00	6	6.00
B1806.2	6.20	101.0	28.0	63.00	6	6.00
B1806.3	6.30	101.0	28.0	63.00	6	6.00
B1806.4	6.40	101.0	28.0	63.00	6	6.00
B1806.5	6.50	101.0	28.0	63.00	6	6.00
B1806.6	6.60	101.0	28.0	63.00	6	6.00
B1806.7	6.70	101.0	28.0	63.00	6	6.00
B1806.8	6.80	109.0	31.0	69.00	6	8.00



Product	DC	OAL	LCF	LB	NOF	DCON MS
	(mm)	(mm)	(mm)	(mm)		(mm)
B1806.9	6.90	109.0	31.0	69.00	6	8.00
B1807.0	7.00	109.0	31.0	69.00	6	8.00
B1807.1	7.10	109.0	31.0	69.00	6	8.00
B1807.2	7.20	109.0	31.0	69.00	6	8.00
B1807.3	7.30	109.0	31.0	69.00	6	8.00
B1807.4	7.40	109.0	31.0	69.00	6	8.00
B1807.5	7.50	109.0	31.0	69.00	6	8.00
B1807.6	7.60	117.0	33.0	75.00	6	8.00
B1807.7	7.70	117.0	33.0	75.00	6	8.00
B1807.8	7.80	117.0	33.0	75.00	6	8.00
B1807.9	7.90	117.0	33.0	75.00	6	8.00
B1808.0	8.00	117.0	33.0	75.00	6	8.00
B1808.1	8.10	117.0	33.0	75.00	6	8.00
B1808.2	8.20	117.0	33.0	75.00	6	8.00
B1808.3	8.30	117.0	33.0	75.00	6	8.00
B1808.4	8.40	117.0	33.0	75.00	6	8.00
B1808.5	8.50	117.0	33.0	75.00	6	8.00
B1808.6	8.60	125.0	36.0	81.00	6	10.00
B1808.7	8.70	125.0	36.0	81.00	6	10.00
B1808.8	8.80	125.0	36.0	81.00	6	10.00
B1808.9	8.90	125.0	36.0	81.00	6	10.00

Product	DC	OAL	LCF	LB	NOF	DCON MS
	(mm)	(mm)	(mm)	(mm)		(mm)
B1809.0	9.00	125.0	36.0	81.00	6	10.00
B1809.1	9.10	125.0	36.0	81.00	6	10.00
B1809.2	9.20	125.0	36.0	81.00	6	10.00
B1809.3	9.30	125.0	36.0	81.00	6	10.00
B1809.4	9.40	125.0	36.0	81.00	6	10.00
B1809.5	9.50	125.0	36.0	81.00	6	10.00
B1809.6	9.60	133.0	38.0	87.00	6	10.00
B1809.7	9.70	133.0	38.0	87.00	6	10.00
B1809.8	9.80	133.0	38.0	87.00	6	10.00
B1809.9	9.90	133.0	38.0	87.00	6	10.00
B18010.0	10.00	133.0	38.0	87.00	6	10.00
B18011.0	11.00	142.0	41.0	96.00	6	10.00
B18012.0	12.00	151.0	44.0	105.00	6	10.00
B18013.0	13.00	151.0	44.0	105.00	6	10.00
B18014.0	14.00	160.0	47.0	110.00	8	14.00
B18015.0	15.00	162.0	50.0	112.00	8	14.00
B18016.0	16.00	170.0	52.0	120.00	8	14.00
B18017.0	17.00	175.0	54.0	123.00	8	14.00
B18018.0	18.00	182.0	56.0	130.00	8	14.00
B18019.0	19.00	189.0	58.0	131.00	8	16.00
B18020.0	20.00	195.0	60.0	137.00	8	16.00



B400



Carbide Straight Shank Machine Reamer with H7 Accuracy, Bright Finish

Designed to provide a finish within the limits of H7 hole tolerance. For superior performance and extended tool life when reaming hard and abrasive materials. The spiral flute design, with extremely unequal spacing between the flutes, reduces vibration and improves hole roundness, size and surface finish.

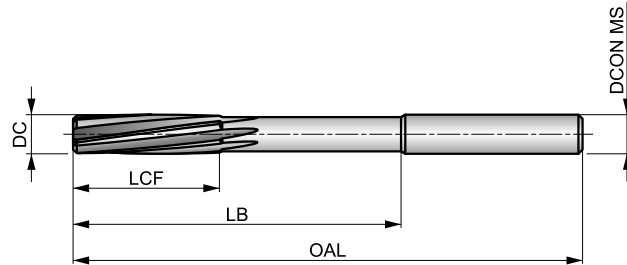

HM	Bright	DIN 8093
R		B
H7		

Workpiece material group suitability, starting values for cutting speed (m/min) and feed Alpha Code. Tables with feed per revolution can be found starting from page XY.

P1.1 ■ 23 B	P1.2 ■ 26 B	P1.3 ■ 27 B	P2.1 ■ 20 B	P2.2 ■ 18 B	P2.3 ■ 16 C	P3.1 ■ 16 B	P3.2 ■ 13 B	P3.3 ■ 11 C	P4.1 ■ 10 B	P4.2 ■ 8 C	P4.3 ■ 7 C	M1.1 ▣ 10 C	M1.2 ▣ 8 C
M2.1 ▣ 9 C	M2.2 ▣ 7 C	M2.3 ▣ 6 B	K1.1 ■ 20 D	K1.2 ■ 15 D	K1.3 ■ 11 D	K2.1 ■ 21 D	K2.2 ■ 17 D	K2.3 ■ 14 D	K3.1 ■ 18 D	K3.2 ■ 14 D	K3.3 ■ 11 D	K5.1 ■ 19 D	K5.2 ■ 15 D
K5.3 ■ 11 D	N1.1 ▣ 60 D	N1.2 ■ 45 D	N1.3 ■ 30 D	N2.1 ■ 38 D	N2.2 ■ 35 D	N2.3 ■ 25 D	N3.1 ■ 64 E	N3.2 ■ 38 E	N3.3 ▣ 19 E	N4.1 ▣ 35 C	N4.2 ▣ 30 C		

DCON MS tolerance h6; DC >= 14 mm Carbide Tipped.

Product	DC (mm)	OAL (mm)	LCF (mm)	LB (mm)	NOF	DCON MS (mm)
B4001.0	1.00	34.0	5.5	15.00	3	1.00
B4001.2	1.20	38.0	7.5	16.50	3	1.20
B4001.4	1.40	40.0	8.0	18.00	3	1.50
B4001.5	1.50	40.0	8.0	18.00	3	1.50
B4001.6	1.60	43.0	9.0	20.00	3	1.60
B4001.8	1.80	46.0	10.0	22.00	4	1.80
B4002.0	2.00	49.0	11.0	24.00	4	2.00
B4002.2	2.20	53.0	12.0	25.00	4	2.20
B4002.5	2.50	57.0	14.0	29.00	4	2.50
B4002.8	2.80	61.0	15.0	33.00	6	3.00
B4003.0	3.00	61.0	15.0	33.00	6	3.00
B4003.2	3.20	65.0	16.0	37.00	6	3.20
B4003.5	3.50	70.0	18.0	42.00	6	3.50
B4004.0	4.00	75.0	19.0	47.00	6	4.00
B4004.5	4.50	80.0	21.0	52.00	6	4.50
B4005.0	5.00	86.0	23.0	58.00	6	5.00
B4005.5	5.50	93.0	26.0	57.00	6	5.60
B4006.0	6.00	93.0	26.0	57.00	6	5.60
B4006.5	6.50	101.0	28.0	65.00	6	6.30
B4007.0	7.00	109.0	31.0	73.00	6	7.10
B4008.0	8.00	117.0	33.0	81.00	6	8.00
B4009.0	9.00	125.0	36.0	85.00	6	9.00
B40010.0	10.00	133.0	38.0	93.00	6	10.00
B40012.0	12.00	151.0	44.0	111.00	6	10.00
B40014.0	14.00	160.0	47.0	115.00	6	12.50
B40016.0	16.00	170.0	52.0	125.00	6	12.50
B40018.0	18.00	182.0	56.0	137.00	6	14.00
B40020.0	20.00	195.0	60.0	147.00	6	16.00



B411



Carbide Tipped Taper Shank Machine Reamer with H7 Accuracy, Bright Finish

The brazed carbide tips gives significant improvements in performance and a longer tool life when you are reaming hard and abrasive materials. The spiral flutes have unequal spacing between them which effectively reduces vibration and improves hole symmetry, size and finish.

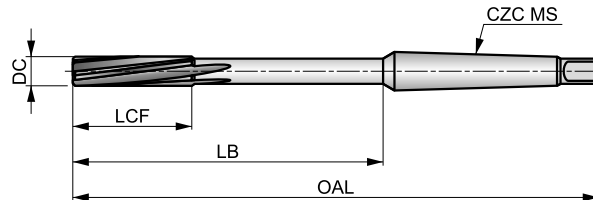

HM	Bright	DIN 8094
R		B
H7		

Workpiece material group suitability, starting values for cutting speed (m/min) and feed Alpha Code. Tables with feed per revolution can be found starting from page XY.

P1.1 ■ 23 B	P1.2 ■ 26 B	P1.3 ■ 27 B	P2.1 ■ 20 B	P2.2 ■ 18 B	P2.3 ■ 16 C	P3.1 ■ 16 B	P3.2 ■ 13 B	P3.3 ■ 11 C	P4.1 ■ 10 B	P4.2 ■ 8 C	P4.3 ■ 7 C	M1.1 ▣ 10 C	M1.2 ▣ 8 C
M2.1 ▣ 9 C	M2.2 ▣ 7 C	M2.3 ▣ 6 B	K1.1 ■ 20 D	K1.2 ■ 15 D	K1.3 ■ 11 D	K2.1 ■ 21 D	K2.2 ■ 17 D	K2.3 ■ 14 D	K3.1 ■ 18 D	K3.2 ■ 14 D	K3.3 ■ 11 D	K5.1 ■ 19 D	K5.2 ■ 15 D
K5.3 ■ 11 D	N1.1 ▣ 60 D	N1.2 ■ 45 D	N1.3 ■ 30 D	N2.1 ■ 38 D	N2.2 ■ 35 D	N2.3 ■ 25 D	N3.1 ■ 64 E	N3.2 ■ 38 E	N3.3 ▣ 19 E	N4.1 ▣ 35 C	N4.2 ▣ 30 C		

DC <= 16mm Carbide head; DC > 16mm Carbide Tipped.

Product	DC (mm)	OAL (mm)	LCF (mm)	LB (mm)	NOF	CZC MS
B4115.0	5.00	133.0	23.0	67.50	6	MK 1
B4116.0	6.00	138.0	26.0	72.50	6	MK 1
B4117.0	7.00	150.0	31.0	84.50	6	MK 1
B4118.0	8.00	156.0	33.0	90.50	6	MK 1
B4119.0	9.00	162.0	36.0	96.50	6	MK 1
B41110.0	10.00	168.0	38.0	102.50	6	MK 1
B41112.0	12.00	182.0	44.0	116.50	6	MK 1
B41114.0	14.00	189.0	47.0	123.50	8	MK 1
B41115.0	15.00	204.0	50.0	124.00	8	MK 2
B41116.0	16.00	210.0	52.0	130.00	8	MK 2
B41117.0	17.00	214.0	54.0	134.00	6	MK 2
B41118.0	18.00	219.0	56.0	139.00	6	MK 2
B41119.0	19.00	223.0	58.0	143.00	6	MK 2
B41120.0	20.00	228.0	60.0	148.00	6	MK 2
B41122.0	22.00	237.0	64.0	157.00	6	MK 2
B41124.0	24.00	268.0	68.0	169.00	8	MK 3
B41125.0	25.00	268.0	68.0	169.00	8	MK 3
B41126.0	26.00	273.0	70.0	174.00	8	MK 3
B41130.0	30.00	281.0	73.0	182.00	8	MK 3



B955



HSS-E Shell Reamer with H7 Accuracy, Bright and Steam Tempered

Shell reamers to be used with an arbor that fits the hole in the reamer. They are precision ground with a left-hand helix and right-hand cutting to provide smooth reaming. With a 45° bevel lead for accurate location and centering in the hole to improve performance and hole quality. Suitable for reaming in many materials.

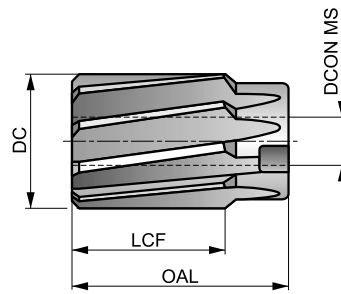

HSS-E	Bright ST	DIN 219
R	B	H7

Workpiece material group suitability, starting values for cutting speed (m/min) and feed Alpha Code. Tables with feed per revolution can be found starting from page XY.

P1.1 ■ 15 C	P1.2 ■ 16 C	P1.3 ■ 17 C	P2.1 ■ 13 C	P2.2 ■ 11 C	P2.3 ■ 10 B	P3.1 ■ 7 B	P3.2 ■ 6 B	P3.3 ■ 5 B	P4.1 ■ 4 B	P4.2 ■ 4 B	P4.3 ■ 3 A	M1.1 ■ 11 C	M1.2 ■ 10 B
M2.1 ■ 9 B	K1.1 ■ 10 E	K1.2 ■ 8 D	K1.3 ■ 7 D	K2.1 ■ 10 C	K2.2 ■ 9 C	K2.3 ■ 6 C	K3.1 ■ 10 C	K3.2 ■ 7 C	N1.1 ■ 17 F	N1.2 ■ 17 F	N1.3 ■ 10 F	N2.1 ■ 23 E	N2.2 ■ 21 E
N2.3 ■ 13 E	N3.1 ■ 34 D	N3.2 ■ 20 E	N3.3 ■ 10 D	N4.1 ■ 24 C									

Product	DC (mm)	OAL (mm)	LCF (mm)	NOF	DCON MS (mm)
B95525.0	25.00	45.0	32.0	8	13.00
B95526.0	26.00	45.0	32.0	8	13.00
B95527.0	27.00	45.0	32.0	8	13.00
B95528.0	28.00	45.0	32.0	8	13.00
B95529.0	29.00	45.0	32.0	8	13.00
B95530.0	30.00	45.0	32.0	8	13.00
B95531.0	31.00	50.0	36.0	10	16.00
B95532.0	32.00	50.0	36.0	10	16.00
B95534.0	34.00	50.0	36.0	10	16.00
B95535.0	35.00	50.0	36.0	10	16.00
B95536.0	36.00	56.0	40.0	10	19.00
B95537.0	37.00	56.0	40.0	10	19.00
B95538.0	38.00	56.0	40.0	10	19.00
B95540.0	40.00	56.0	40.0	10	19.00

Product	DC (mm)	OAL (mm)	LCF (mm)	NOF	DCON MS (mm)
B95542.0	42.00	56.0	40.0	10	19.00
B95544.0	44.00	63.0	45.0	12	22.00
B95545.0	45.00	63.0	45.0	12	22.00
B95548.0	48.00	63.0	45.0	12	22.00
B95550.0	50.00	63.0	45.0	12	22.00
B95552.0	52.00	71.0	50.0	12	27.00
B95555.0	55.00	71.0	50.0	12	27.00
B95558.0	58.00	71.0	50.0	12	27.00
B95560.0	60.00	71.0	50.0	12	27.00
B95565.0	65.00	80.0	56.0	14	32.00
B95570.0	70.00	80.0	56.0	14	32.00
B95575.0	75.00	90.0	63.0	14	40.00
B95580.0	80.00	90.0	63.0	14	40.00



B956



Shell Reamer Arbor for B955

Arbor used to hold shell reamers in machine applications. It has a taper shank to be held directly in the machine spindle. For arbor spare parts (drivers, nuts and washers) please see Dormer's B957 range for availability.

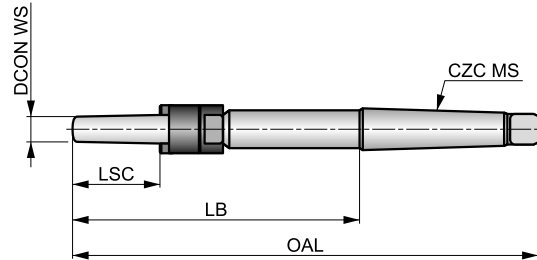

HSS-E	Bright	DIN 217

Product	DCON WS (mm)	OAL (mm)	LSC (mm)	LB (mm)	CZC MS
B95613.0	13.00	250.0	45	151.00	MK 3
B95616.0	16.00	261.0	50	162.00	MK 3
B95619.0	19.00	298.0	56	174.00	MK 4
B95622.0	22.00	312.0	63	188.00	MK 4
B95627.0	27.00	359.0	71	203.00	MK 5
B95632.0	32.00	376.0	80	220.00	MK 5
B95640.0	40.00	396.0	90	240.00	MK 5



G138



HSS Taper Shank 90° Countersink, Bright Finish

A 90° Countersink designed for chamfering standard fastener holes and removing burrs from drilled holes. Taper shank design allows the tool to be used in machine applications where it is held directly in the spindle. Suitable to chamfer holes in many materials.

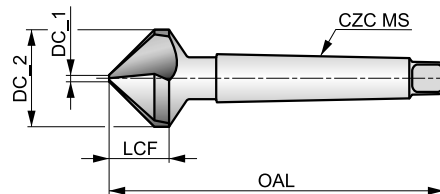

HSS	Bright	DIN 335D
R	90°	

Workpiece material group suitability, starting values for cutting speed (m/min) and feed Alpha Code. Tables with feed per revolution can be found starting from page XY.

P1.1 ■ 23 E	P1.2 ■ 26 E	P1.3 ■ 27 E	P2.1 ■ 20 E	P2.2 ■ 18 D	P2.3 ▧ 16 B	P3.1 ■ 16 D	P3.2 ▧ 13 D	P3.3 ▧ 11 B	P4.1 ■ 10 D	P4.2 ▧ 8 B	M1.1 ▧ 8	M1.2 ▧ 6	M2.1 ▧ 7
M2.2 ▧ 6	K1.1 ▧ 20 F	K1.2 ▧ 15 D	K2.1 ▧ 21 C	K2.2 ▧ 17 C	K3.1 ▧ 18 C	K3.2 ▧ 14 C	K5.1 ▧ 19 C	K5.2 ▧ 15 C	N1.1 ▧ 40 G	N1.2 ■ 30 G	N1.3 ▧ 20 F	N2.1 ■ 20 F	N2.2 ▧ 18 F
N3.1 ■ 21 F	N3.2 ■ 12 F	N3.3 ▧ 6 D	N4.1 ▧ 40 G	N4.2 ▧ 35 G									

Product	DC_2 (mm)	DC_1 (mm)	LCF (mm)	OAL (mm)	CZC MS	NOF
G13825.0	25.00	3.80	15.5	106.0	MK 2	3
G13830.0	30.00	4.20	18.5	112.0	MK 2	3
G13831.0	31.00	4.20	20.0	112.0	MK 2	3
G13834.0	34.00	4.50	19.5	118.0	MK 2	3
G13837.0	37.00	4.80	21.7	118.0	MK 2	3
G13840.0	40.00	10.00	20.5	140.0	MK 3	3
G13850.0	50.00	14.00	24.1	150.0	MK 3	3
G13863.0	63.00	16.00	28.5	180.0	MK 4	3
G13880.0	80.00	22.00	36.0	190.0	MK 4	3



G570



HSS-E Straight Shank 90° Countersink, AlTiCN Coated

A 90° Countersink designed for chamfering holes to accommodate standard fasteners and clean burrs from drilled holes. Can be used in machine and hand-held applications. Particularly suited to chamfering holes in hard and abrasive materials. AlTiCN coating improves performance and extends tool life.

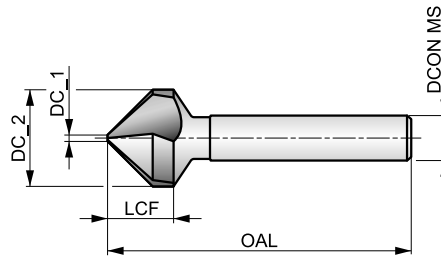

HSS-E	AlTiCN	DIN 335C
R	90°	

Workpiece material group suitability, starting values for cutting speed (m/min) and feed Alpha Code. Tables with feed per revolution can be found starting from page XY.

P1.1 ■ 40 E	P1.2 ■ 45 E	P1.3 ■ 46 E	P2.1 ■ 34 E	P2.2 ■ 30 D	P2.3 ■ 27 B	P3.1 ■ 28 D	P3.2 ■ 22 D	P3.3 ■ 19 B	P4.1 ■ 16 D	P4.2 ■ 14 B	P4.3 ■ 11 B	M1.1 ■ 23 C	M1.2 ■ 20 C
M2.1 ■ 21 C	M2.2 ■ 17 C	M2.3 ■ 14 A	M3.1 ■ 14 B	M3.2 ■ 12 B	M3.3 ■ 11 B	M4.1 ■ 15 A	M4.2 ■ 13 A	K1.1 ■ 41 C	K1.2 ■ 30 C	K1.3 ■ 23 C	K2.1 ■ 42 C	K2.2 ■ 34 C	K2.3 ■ 27 C
K3.1 ■ 37 C	K3.2 ■ 28 C	K3.3 ■ 23 C	K4.1 ■ 34 C	K4.2 ■ 26 C	K4.3 ■ 19 C	K5.1 ■ 39 C	K5.2 ■ 29 C	K5.3 ■ 23 C	N1.1 ■ 60 G	N1.2 ■ 45 G	N1.3 ■ 30 F	N2.1 ■ 30 F	N2.2 ■ 27 F
N2.3 ■ 19 F	N3.1 ■ 32 F	N3.2 ■ 18 F	N3.3 ■ 19 D										

DCON MS tolerance h9.

Product	DC_2 (mm)	DC_1 (mm)	LCF (mm)	OAL (mm)	DCON MS (mm)	NOF
G5706.3	6.30	1.50	6.5	45.0	5.00	3
G5708.3	8.30	2.00	8.2	50.0	6.00	3
G57010.4	10.40	2.50	9.7	50.0	6.00	3
G57012.4	12.40	2.80	10.6	56.0	8.00	3
G57016.5	16.50	3.20	13.9	60.0	10.00	3
G57020.5	20.50	3.50	17.1	63.0	10.00	3
G57025.0	25.00	3.80	21.4	67.0	10.00	3
G57031.0	31.00	4.20	24.4	71.0	12.00	3



REAMERS FEED RATE CHART

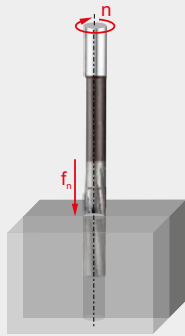

Feed per revolution (f_n in mm/rev)
Depending on the working conditions
it might be necessary to adjust these
values $\pm 15\%$.

How to use this table to find the feed per revolution (f_n):

1. Find your Alpha Code on the product page (example: 21C, "C" is the Alpha Code).
2. Find the closest diameter for your cutting application in the top row of the table.
3. Find your Alpha Code in the left column of the table.
4. The intersection (cell) of the Diameter and Alpha Code is the feed per revolution (f_n).

		\varnothing DC (mm)																		
		1.00	1.50	2.00	3.00	4.00	5.00	6.00	7.00	8.00	10.00	12.00	15.00	16.00	20.00	25.00	30.00	40.00	50.00	80.00
Feed rates	A	0.030	0.045	0.055	0.078	0.090	0.100	0.125	0.137	0.150	0.170	0.185	0.210	0.220	0.250	0.280	0.320	0.390	0.440	0.500
	B	0.035	0.055	0.072	0.110	0.130	0.150	0.165	0.172	0.180	0.210	0.240	0.270	0.280	0.310	0.360	0.400	0.500	0.550	0.600
	C	0.040	0.065	0.085	0.135	0.160	0.185	0.200	0.210	0.220	0.260	0.285	0.325	0.335	0.390	0.440	0.480	0.600	0.680	0.750
	D	0.050	0.080	0.110	0.160	0.180	0.200	0.235	0.253	0.270	0.320	0.360	0.400	0.410	0.470	0.540	0.600	0.730	0.850	0.950
	E	0.065	0.100	0.140	0.180	0.215	0.250	0.300	0.325	0.350	0.390	0.430	0.485	0.500	0.530	0.640	0.750	0.910	1.100	1.200
	F	0.090	0.140	0.180	0.260	0.305	0.350	0.395	0.417	0.440	0.500	0.550	0.610	0.630	0.700	0.800	0.930	1.200	1.500	1.650

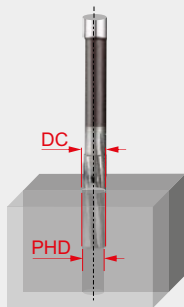

Machining allowance when using
a **machine reamer** (MA in mm)
Premachined hole diameter
 $PHD = DC - MA$.

How to use this table to get to the right premachined hole diameter (PHD):

1. Find the diameter range for your cutting application in the top row of the table.
2. Find your ISO Group Code in the left column of the table (example: For Stainless Steel the ISO Group Code is "M")
3. The intersection (cell) of the Diameter Range and ISO Group Code is the Machining Allowance (MA)
4. Subtract the Machining Allowance from the reaming diameter to get to the premachined hole diameter (PHD).

(example: for a 6mm hole in steel (P) the PHD is 5.85mm)

		\varnothing DC (mm)															
		1.00	5.00	5.00	8.00	8.00	12.00	12.00	16.00	16.00	30.00	30.00	80.00				
ISO group	P	0.10			0.15			0.20			0.20			0.30			0.30
	M	0.08			0.10			0.10			0.20			0.20			0.30
	K	0.10			0.15			0.20			0.20			0.30			0.30
	N	0.10			0.15			0.20			0.20			0.30			0.30
	S	0.05			0.10			0.10			0.15			0.20			0.20
	H	0.05			0.05			0.10			0.10			0.15			0.20

Be cautious with the machining tolerances of drills, the tool diameter is not the same as the hole diameter produced!

Note: The recommended allowance when using a hand reamer is 0.05 to 0.10 mm.



COUNTERSINKS FEED RATE CHART

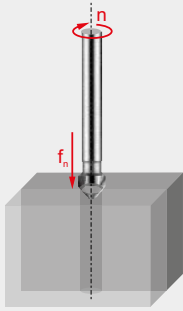

Feed per revolution (f_n in mm/rev)
Depending on the working conditions
it might be necessary to adjust these
values $\pm 15\%$.

How to use this table to find the feed per revolution (f_n):

1. Find your Alpha Code on the product page (example: 23E, "E" is the Alpha Code).
2. Find the closest diameter for your cutting application in the top row of the table.
3. Find your Alpha Code in the left column of the table.
4. The intersection (cell) of the Diameter and Alpha Code is the feed per revolution (f_n).

		$\varnothing DC$ (mm)									
		6.00	8.00	10.00	16.00	20.00	25.00	32.00	40.00	60.00	80.00
Feed rates	A	0.030	0.040	0.050	0.060	0.080	0.090	0.100	0.120	0.140	0.160
	B	0.040	0.050	0.060	0.080	0.100	0.120	0.140	0.160	0.180	0.200
	C	0.050	0.060	0.080	0.100	0.120	0.140	0.160	0.180	0.200	0.220
	D	0.060	0.080	0.100	0.120	0.150	0.180	0.200	0.220	0.250	0.280
	E	0.080	0.100	0.120	0.150	0.180	0.200	0.250	0.270	0.300	0.320
	F	0.090	0.110	0.130	0.160	0.190	0.210	0.260	0.290	0.330	0.360
	G	0.100	0.120	0.150	0.180	0.200	0.220	0.280	0.320	0.360	0.400
	H	0.120	0.150	0.180	0.200	0.220	0.250	0.300	0.350	0.400	0.450



REAMING – GENERAL HINTS – TECHNICAL INFO

Trouble shooting when reaming

Problem	Cause	Remedy
Broken or twisted tangs	Incorrect fit between shank and socket	Ensure the shank and socket are clean and free from damage
Rapid tool wear	Insufficient stock to remove	Increase the amount of stock to be removed (smaller hole)
Oversize hole	Excessive lip height variation	Regrind to correct specification
	Displacement in the machine spindle	Repair and rectify spindle displacement
	Defects on the tool holder	Replace tool holder
	Tool shank is damaged	Replace or regrind the shank
	Ovality of the tool	Replace or regrind the tool
	Asymmetric bevel lead angle	Regrind to correct specification
	Too high feed or cutting speed	Adjust cutting conditions in accordance with Catalogue
Undersize hole	Insufficient stock to remove	Increase the amount of stock to be removed (smaller hole)
	Too much heat generated while reaming. The hole widens and shrinks	Increase coolant flow
	The tool diameter is worn and is undersize	Regrind to correct specification or replace tool
	Too low feed or cutting speed	Adjust cutting conditions in accordance with the Catalogue
	Pre-drilled hole is too small	Decrease the amount of stock to be removed (larger hole)
Oval and conical holes	Displacement in the machine spindle	Repair and rectify spindle displacement
	Misalignment between tool and hole	Use a bridge reamer
	Asymmetric bevel lead angle	Regrind to correct specification
Bad hole finish	Excessive stock to remove	Decrease the amount of stock to be removed (larger hole)
	Worn out tool	Regrind to correct specification
	Undersize cutting rake angle	Regrind to correct specification
	Too diluted emulsion or cutting oil	Increase % concentration
	Feed and/or speed too low	Adjust cutting conditions in accordance with Catalogue
	Cutting speed too high	Adjust cutting conditions in accordance with Catalogue
The tool clamps and breaks	Worn out tool	Regrind to correct specification
	Back taper of the tool is too small	Check and replace/modify the tool
	The width of the land is too wide	Check and replace/modify the tool
	Workpiece material tend to squeeze	Use an adjustable reamer to compensate for the displacement
	Pre-drilled hole is too small	Decrease the amount of stock to be removed (larger hole)
	Heterogeneous material with hard inclusions	Use solid carbide reamer



DORMER PRAMET



EVERY APPLICATION

Whether you are hole-making, milling, turning or threading, every application is covered within our machining calculator app. Download it today from your relevant app store. **Simply Reliable.**

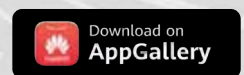
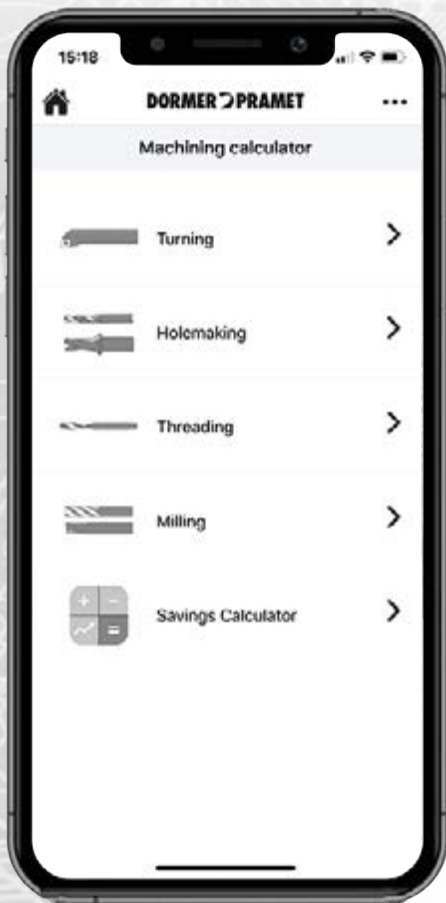



EXCHANGEABLE HEAD, INDEXABLE DRILLS



INDEXABLE DRILLS – PAGE OVERVIEW

1 **802D** **P M K N S** **2** **PRAMET** **3** **S**



2xD 802D Indexable Insert Drill body with Internal Coolant Feed

High performance indexable insert drill body for drilling blind and through holes. Also, potentially cross hole, off center and stack drilling, helical interpolation, plunging, drilling on concave or angled surfaces, drilling with interrupted cuts, chamfer drilling and boring. Available from Ø15 up to Ø40 mm in 2xD. **4**

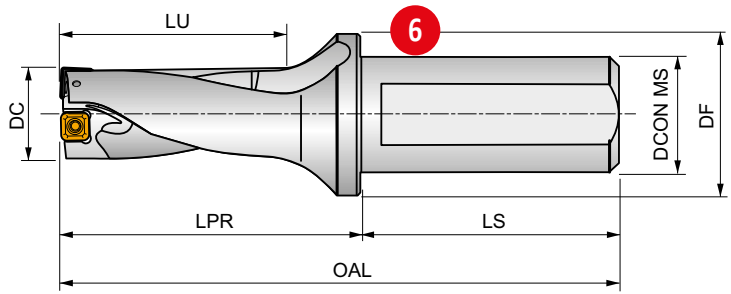

2xD **1** **ISO 9766** **7**

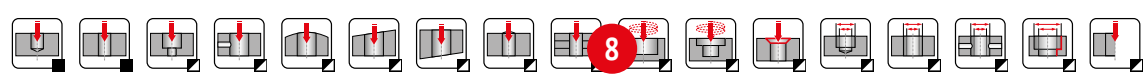

Product	DC	APMX	OAL	LPR	LS	LU	DCON MS	DF	\bar{D}	D^+														
	[mm]	[mm]	[mm]	[mm]	[mm]	[mm]	[mm]	[mm]	[mm]	[mm]														
802D-15-30-S25	15	30.00	121	65	56	34.5	25	35	0.25	0.35	EP253253	G1300	G1313	0.30	HM001									
802D-16-32-S25	16	32.00	123	67	56	37	25	35	0.45	0.50	EP253253	G1300	G1313	0.30	HM001									
802D-17-34-S25	17	34.00	125	69	56	39.5	25	35	0.50	0.55	EP253253	G1300	G1313	0.30	HM001									
802D-18-36-S25	18	36.00	127	71	56	42	25	35	0.35	0.25	EP253253	G1301	G1314	0.31	HM002									
802D-19-38-S25	19	38.00	129	73	56	44.5	25	35	0.15	0.45	EP253253	G1301	G1314	0.32	HM002									

G1300	XPET 0502AP	SCET 050204-UD
G1301	XPET 0602AP	SCET 050204-UD
G1302	XPET 0602AP	SCET 060204-UD
G1303	XPET 0703AP	SCET 060204-UD
G1304	XPET 0703AP	SCET 070308-UD
G1305	XPET 0903AP	SCET 070308-UD
G1306	XPET 0903AP	SCET 09T308-UD
G1307	XPET 11T3AP	SCET 09T308-UD
G1308	XPET 11T3AP	SCET 120408-UD
G1309	XPET 12T3AP	SCET 120408-UD
G1313	XPET 0502AP-SD	SCET 050204-SD
G1314	XPET 0602AP-SD	SCET 050204-SD
G1315	XPET 0602AP-SD	SCET 060204-SD
G1316	XPET 0703AP-SD	SCET 060204-SD
G1317	XPET 0703AP-SD	SCET 070308-SD
G1318	XPET 0903AP-SD	SCET 070308-SD
G1319	XPET 0903AP-SD	SCET 09T308-SD
G1320	XPET 11T3AP-SD	SCET 09T308-SD
G1321	XPET 11T3AP-SD	SCET 120408-SD
G1322	XPET 12T3AP-SD	SCET 120408-SD

G1300	XPET 0502AP	SCET 050204-UD
G1301	XPET 0602AP	SCET 050204-UD
G1302	XPET 0602AP	SCET 060204-UD
G1303	XPET 0703AP	SCET 060204-UD



INDEXABLE DRILLS – PAGE OVERVIEW

Pos.	Description	Pos.	Description
1	Designation of drill	11	Radial setting (mm)
2	Material group recommendations	12	Adjustable sleeve
3	Clamping system of insert	13	Group of compatible inserts with chip breaker UD ^{1),2)}
4	Tool description	14	Group of compatible inserts with chip breaker SD ^{1),2)}
5	Illustrative picture	15	Weight (kg)
6	Schematic drawing of tool	16	Group of spare parts ¹⁾
7	Product features	17	Compatible inserts with chip breaker UD
8	Product applications	18	Compatible inserts with chip breaker SD
9	Tool code	19	Spare parts
10	Tool dimensions		

¹⁾ Code of Group of compatible inserts and spare parts is used only for purposes of this catalogue. It cannot be used for orders.

²⁾ External (SCET) and internal (XPET) inserts must always have the same chip breaker (please note: UD chip breaker is not visibly included in designation of XPET inserts – e.g. XPET 0502AP); info needed for correct choice of chip breaker (UD vs SD) can be found on the insert packaging.

1 H851



HYDRA Body 1.5XD, with Coolant Feed, Bright Nickel Plating

Used with R950, R960 and R970 HYDRA heads. A range of head diameters can be used with the same body. Coolant holes aligned with the heads offer efficient cooling. Flanged shank prevents the drill from wandering in the holder. Nickel Plated surface protects from rust and corrosion, and improves chip evacuation.

2

HYDRA

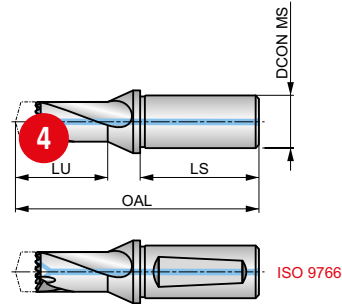

HSS	DORMER	1.5×D
Bright Ni	ISO 9766	R

5

Four (4) screws and one (1) screwdriver are included with a drill body, DCON MS tolerance h6.

Product	DCONMS	DCON MS	LU	OAL	LS	ADINTMS
	[inch]	[mm]	[mm]	[mm]	[mm]	
H85131/64	5/8	15.88	25.50	88.5	47.6	Cylindrical
H8511/2	5/8	15.88	25.80	88.8	47.6	Cylindrical
H85117/32	5/8	15.88	30.90	93.9	47.6	Cylindrical
H85112.0	–	16.00	25.50	88.5	48.0	ISO 9766
H85112.5	–	16.00	25.80	88.8	48.0	ISO 9766
H85113.0	–	16.00	27.00	90.0	48.0	ISO 9766
H85114.0	–	16.00	30.90	93.9	48.0	ISO 9766
H8519/16	3/4	19.05	30.30	93.9	50.8	Cylindrical
H85139/64	3/4	19.05	32.30	97.3	50.8	Cylindrical
H85111/16	3/4	19.05	39.00	101.4	50.8	Cylindrical
H85123/32	3/4	19.05	39.00	104.0	50.8	Cylindrical
H85115.0	–	20.00	32.30	97.3	50.0	ISO 9766
H85116.0	–	20.00	34.90	99.9	50.0	ISO 9766
H85117.0	–	20.00	36.40	101.4	50.0	ISO 9766
H85118.0	–	20.00	39.00	104.0	50.0	ISO 9766
H85119.0	–	25.00	40.40	111.4	56.0	ISO 9766
H85120.0	–	25.00	43.00	114.0	56.0	ISO 9766
H85121.0	–	25.00	44.50	115.5	56.0	ISO 9766

6

Pos.	Description
1	Designation of drill
2	Product description
3	Illustrative picture
4	Schematic drawing of tool

Pos.	Description
5	Product features
6	Product code
7	Product dimensions



EXCHANGEABLE HEAD & INDEXABLE DRILLS – ICONS OVERVIEW

GENERAL ICONS



Primary use



Possible use



Drill Point 140°

BASIC STANDARD GROUP (BSG)



Dormer Standards

CLAMPING DESIGNATION



S – Screw clamp

COATING



Bright Nickel Plating



Special TiAlN Coating (+ Silicon + Chromium)

COOLANT SUPPLY PROPERTY (CSP)



Through Tool Coolant

CUTTING DIAMETER TOLERANCE ZONE CLASS (TCDC)



h7 – Industry Standard Tool Tolerance Zone (based on diameter range)

CUTTING DIRECTION



Right Hand Rotation / Cutting

GENERAL FEATURES OF TOOLS



1 effective tooth per revolution



Possibility of use for eccentric machining



Monoblock design



Universal shank

INSERT CUTTING EDGE



Rounded edge with facet

INSERT FEATURES



For tough machined materials (long chip)



Heavy working conditions



Universal wide range option

MATERIAL CODE (BMC)



Hard Material (Solid Carbide)



High Speed Steel Tool Material

OPERATIONS DRILLING



Blind hole boring



Drilling across an existing hole



Chamfering (beveling)



Blind hole drilling



Drilling of stacked materials



Interrupted cut



Boring



Drilling onto curved surface



Through hole boring



Boring through cross holes



Drilling onto inclined surface



Through hole drilling



Boring up to a shoulder



Helical interpolation boring



Welded joint drilling



Drill exit on inclined surface



Helical interpolation drilling



EXCHANGEABLE HEAD & INDEXABLE DRILLS – ICONS OVERVIEW

OTHER ICONS

 Clamping torque of screw (Nm)

SHANK

 Cylindrical Shank with Flange

 ISO 9766 Cylindrical Shanks (with or without Flat)

 DIN 6535 – HB (Weldon) or HE (Whistle Notch) Shank

TECHNICAL PAGES

 Feed (mm/rev)

 High cutting speed, system rigidity slightly limited (depth of cut changing)

 Low cutting speed, low system rigidity (interrupted cut)

 Very high cutting speed, excellent system rigidity (stable working conditions)

 Medium cutting speed, system rigidity limited (slightly interrupted cut)

 Very low cutting speed, very low system rigidity (very unstable working conditions)

 High cutting speed, high system rigidity (stable working conditions)

USABLE LENGTH DIAMETER RATIO (ULDR)

1.5×D 1.5×D Usable Tool Depth to Diameter Ratio

5×D 5×D Usable Tool Depth to Diameter Ratio

2×D 2×D Usable Tool Depth to Diameter Ratio

12×D 12×D Usable Tool Depth to Diameter Ratio

8×D 8×D Usable Tool Depth to Diameter Ratio

4×D 4×D Usable Tool Depth to Diameter Ratio

3×D 3×D Usable Tool Depth to Diameter Ratio





HYDRA

HIGH PERFORMANCE REPLACEABLE HEAD DRILLS

Interchangeable solid carbide head drills for high performance machining of steels, stainless steels and cast iron. Fail-safe head location can be changed without ejecting the drill from the machine. Available with coolant feed and a choice of HSS bodies from 1.5xD for improved rigidity in shallow hole and plate drilling, through to 12xD for deeper hole applications.

FEATURES AND BENEFITS

- **Consistently high performance**, even after numerous head changes.
- **Reduction in inventory costs** – one body can fit multiple solid carbide head sizes.
- **Versatile** – cylindrical shank with flat allows use in multiple types of holder.
- **Easy and quick head changes** with minimal interruptions to the production process. Heads can be changed without removing the body from the machine.
- Exact fit of head to body maximises tool rigidity for **superior hole accuracy** and precise tolerances.

MATERIAL

PREMIUM MICROGRAIN CARBIDE (Heads)

- Micrograin carbide provides an excellent combination of hardness and toughness, resulting in high wear resistance and longer tool life.

HARDENED STEEL (Body)

- Hardened steel with high gloss nickel plating for high resistance to wear and corrosion.

COATING

TITANIUM ALUMINIUM NITRIDE BASED COATING PROVIDES:

- High toughness and oxidation resistance.
- Outstanding wear protection in abrasive materials like Cast Iron.
- High hardness at high temperatures created when drilling Cast Irons.
- Increased tool life and productivity.

HEAD TYPES



R950

STEEL



R960

STAINLESS STEEL



R970

CAST IRON



HYDRA

HIGH PERFORMANCE REPLACEABLE HEAD DRILLS

GEOMETRY

CORNER DESIGN

- A strong corner design increases stability during drilling and reduces the forces encountered during breakthrough of the exit surface.
- This improves the quality of the exit surface and helps prevent “exit burst” which can occur when drilling granular materials.

POINT GEOMETRY

- 140 degree split point geometry provides good centering capabilities and low thrust forces when drilling most materials.

A COMPLETE RANGE

- Available in 1.5xD, 3xD, 5xD, 8xD and 12xD lengths incorporating coolant holes to improve cutting efficiency and swarf evacuation, resulting in higher productivity.
- Metric: 12.00 mm to 42.00 mm.
- Fractional: 15/32 inch to 1.5/8 inch.
- Best results are obtained using hydraulic holders. Can also be held in ER and Weldon type toolholders.



BODY LENGTHS

1.5xD



3xD



5xD



8xD



12xD





HYDRA DRILLS – NAVIGATOR TOOL MATERIALS



Tool materials

High Speed Steel		A medium-alloyed high speed steel that has good machinability and good performance. HSS exhibits hardness, toughness and wear resistance characteristics that make it attractive in a wide range of applications, for example in drills and taps.
-------------------------	---	---

Carbide materials

Carbide Materials (or Hard Materials)		<p>A sintered powder metallurgy substrate, consisting of a metallic carbide composite with binder metal. The most central raw material is tungsten carbide (WC). Tungsten carbide contributes to the hardness of the material. Tantalum carbide (TaC), titanium carbide (TiC) and niobium carbide (NbC) complements WC and adjusts the properties to what is desired. These three materials are called cubic carbides. Cobalt (Co) acts as a binder and keeps the material together.</p> <p>Carbide materials are often characterised by high compression strength, high hardness and therefore high wear resistance, but also by limited flexural strength and toughness. Carbide is used in taps, reamers, milling cutters, drills and thread milling cutters.</p>
--	---	--

Surface Coatings

Bright Nickel Plating		Bright Nickel Plated surface protects hardened steel body from rust, corrosion and also improves chip evacuation.
Ti-phon (TiAlCrSiN)		Ti-phon Coating is a coating similar to TiAlN but with the addition of Chromium (Cr) and Silicon (Si) which is specially formulated for Hydra Heads to prevent edge build-up and greatly improve chip flow. This coating exhibits high hot hardness, high oxidation resistance and superior lubricity when used on tools for machining applications involving heavy mechanical and thermal stresses, high speeds and high feed rates. These coating properties translate into superior wear resistance and edge strength.



		HM	HM	HM	HSS	HSS	HSS	HSS	HSS					
Material code (BMC)		HM	HM	HM	HSS	HSS	HSS	HSS	HSS					
Basic standard group (BSG)		DORMER	DORMER	DORMER	DORMER	DORMER	DORMER	DORMER	DORMER					
Usable length (ULDR)					1.5xD	3xD	5xD	8xD	12xD					
Application angle		140°	140°	140°										
Coating		Ti-phos	Ti-phos	Ti-phos	Bright Ni	Bright Ni	Bright Ni	Bright Ni	Bright Ni					
Shank					ISO 9766	DIN 6535HB DIN 6535HE	DIN 6535HB DIN 6535HE	DIN 6535HB DIN 6535HE	DIN 6535HB DIN 6535HE					
Hand (Cutting direction)		R	R	R	R	R	R	R	R					
Cooling (CSP)														
		HYDRA	HYDRA	HYDRA	HYDRA	HYDRA	HYDRA	HYDRA	HYDRA	HYDRA	HYDRA	HYDRA	HYDRA	HYDRA
					NEW					NEW				
Product Family Code		R950	R960	R970	H851	H853	H855	H858	H8512	H860	H861			
		12.00 - 42.00, 15/32 - 1.5/8	12.00 - 30.50, 15/32 - 1.3/16	12.00 - 42.00, 15/32 - 1.5/8	12.00 - 30.50, 15/32 - 1.3/16	12.00 - 42.50, 15/32 - 1.5/8	12.00 - 42.50, 15/32 - 1.5/8	13.50 - 42.50, 35/64 - 1.5/8	13.50 - 25.65, 35/64 - 1.1/64	N1 - N7	N1 - N6			
		488	490	492	494	496	498	500	501	502	503			
P	P1	■	■											
	P2	■	■											
	P3	■												
	P4	■												
M	M1		■											
	M2		■											
	M3		■											
	M4		■											
K	K1		■	■										
	K2	■	■	■										
	K3	■	■	■										
	K4	■	■	■										
	K5	■	■	■										
N	N1													
	N2													
	N3													
	N4													
	N5													
S	S1		■											
	S2		■											
	S3		■											
	S4		■											
H	H1													
	H2													
	H3													
	H4													



R950



HYDRA Drill Head for Steels, Ti-phon Coated

Highly cost-effective and accurate design replaceable head for high performance in steels and harder materials. A 140° split point helps with self-centering and reduces cutting forces. Ti-phon coating prevents edge build-up and greatly improves chip flow, with superior wear resistance and edge strength.

HYDRA

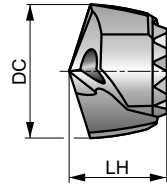

HM	DORMER	140°
Ti-phon	R	
DC h7		

Workpiece material group suitability, starting values for cutting speed (m/min) and feed Alpha Code. Tables with feed per revolution can be found starting from page XY.

P1.1	P1.2	P1.3	P2.1	P2.2	P2.3	P3.1	P3.2	P3.3	P4.1	P4.2	P4.3	M2.3	M4.2
■ 133 W	■ 148 W	■ 154 W	■ 114 W	■ 100 W	■ 88 W	■ 125 W	■ 101 W	■ 85 W	■ 75 W	■ 63 W	■ 52 T	■ 41 T	■ 35 T
K2.1	K2.2	K2.3	K3.1	K3.2	K3.3	K4.1	K4.2	K4.3	K4.4	K4.5	K5.1	K5.2	K5.3
■ 108 V	■ 88 V	■ 70 V	■ 96 V	■ 73 V	■ 59 V	■ 89 V	■ 67 V	■ 49 V	■ 42 V	■ 35 V	■ 100 V	■ 76 V	■ 58 V

Product	DC	DC	DC	LH
	(inch)	(mm)	(inch)	(mm)
R95015/32	15/32	11.91	0.4688	9.1
R95012.0	–	12.00	0.4724	9.1
R95012.1	–	12.10	0.4764	9.1
R95012.2	–	12.20	0.4803	9.1
R95031/64	31/64	12.30	0.4844	9.1
R95012.5	–	12.50	0.4921	9.4
R95012.6	–	12.60	0.4961	9.4
R9501/2	1/2	12.70	0.5000	9.4
R95012.8	–	12.80	0.5039	9.4
R95012.9	–	12.90	0.5079	9.4
R95013.0	–	13.00	0.5118	9.7
R95033/64	33/64	13.10	0.5156	9.7
R95013.2	–	13.20	0.5197	9.7
R95017/32	17/32	13.49	0.5313	9.7
R95013.5	–	13.50	0.5315	10.3
R95013.6	–	13.60	0.5354	10.3
R95013.7	–	13.70	0.5394	10.3
R95013.8	–	13.80	0.5433	10.3
R95035/64	35/64	13.89	0.5469	10.3
R95014.0	–	14.00	0.5512	10.3
R95014.1	–	14.10	0.5551	10.3
R95014.2	–	14.20	0.5591	10.3
R9509/16	9/16	14.29	0.5625	10.3
R95014.5	–	14.50	0.5709	10.3
R95014.6	–	14.60	0.5748	11.0
R95037/64	37/64	14.68	0.5781	11.0
R95014.7	–	14.70	0.5787	11.0
R95014.8	–	14.80	0.5827	11.0
R95015.0	–	15.00	0.5906	11.0
R95019/32	19/32	15.08	0.5938	11.0

Product	DC	DC	DC	LH
	(inch)	(mm)	(inch)	(mm)
R95015.1	–	15.10	0.5945	11.0
R95015.2	–	15.20	0.5984	11.0
R95015.24	–	15.24	0.6000	11.0
R95039/64	39/64	15.48	0.6094	11.0
R95015.5	–	15.50	0.6102	11.0
R95015.6	–	15.60	0.6142	11.6
R95015.7	–	15.70	0.6181	11.6
R9505/8	5/8	15.88	0.6250	11.6
R95016.0	–	16.00	0.6299	11.6
R95016.08	–	16.08	0.6331	11.6
R95016.1	–	16.10	0.6339	11.6
R95016.2	–	16.20	0.6378	11.6
R95041/64	41/64	16.27	0.6406	11.6
R95016.3	–	16.30	0.6417	11.6
R95016.5	–	16.50	0.6496	11.6
R95016.6	–	16.60	0.6535	12.2
R95021/32	21/32	16.67	0.6563	12.2
R95016.7	–	16.70	0.6575	12.2
R95017.0	–	17.00	0.6693	12.2
R95043/64	43/64	17.07	0.6719	12.2
R95017.1	–	17.10	0.6732	12.2
R95017.2	–	17.20	0.6772	12.2
R95011/16	11/16	17.46	0.6875	12.2
R95017.5	–	17.50	0.6890	12.2
R95017.6	–	17.60	0.6929	12.9
R95017.7	–	17.70	0.6969	12.9
R95045/64	45/64	17.86	0.7031	12.9
R95018.0	–	18.00	0.7087	12.9
R95018.1	–	18.10	0.7126	12.9
R95018.2	–	18.20	0.7165	12.9



Product	DC	DC	DC	LH
	(inch)	(mm)	(inch)	(mm)
R95023/32	23/32	18.26	0.7188	12.9
R95018.5	—	18.50	0.7283	12.9
R95018.6	—	18.60	0.7323	13.5
R95047/64	47/64	18.65	0.7344	13.5
R95018.7	—	18.70	0.7362	13.5
R95018.9	—	18.90	0.7441	13.5
R95019.0	—	19.00	0.7480	13.5
R9503/4	3/4	19.05	0.7500	13.5
R95019.1	—	19.10	0.7520	13.5
R95019.2	—	19.20	0.7559	13.5
R95019.25	—	19.25	0.7579	13.5
R95019.3	—	19.30	0.7598	13.5
R95019.35	—	19.35	0.7618	13.5
R95049/64	49/64	19.45	0.7656	13.5
R95019.5	—	19.50	0.7677	13.5
R95019.6	—	19.60	0.7717	14.1
R95019.7	—	19.70	0.7756	14.1
R95025/32	25/32	19.84	0.7813	14.1
R95020.0	—	20.00	0.7874	14.1
R95051/64	51/64	20.24	0.7969	14.1
R95020.5	—	20.50	0.8071	14.1
R95013/16	13/16	20.64	0.8125	14.8
R95021.0	—	21.00	0.8268	14.8
R95053/64	53/64	21.03	0.8281	14.8
R95027/32	27/32	21.43	0.8438	14.8
R95021.5	—	21.50	0.8465	14.8
R95055/64	55/64	21.83	0.8594	15.0
R95022.0	—	22.00	0.8661	15.0
R9507/8	7/8	22.22	0.8750	15.0
R95022.5	—	22.50	0.8858	15.0
R95057/64	57/64	22.62	0.8906	15.0
R95022.7	—	22.70	0.8937	15.0
R95023.0	—	23.00	0.9055	15.1
R95029/32	29/32	23.02	0.9063	15.1
R95059/64	59/64	23.42	0.9219	15.1
R95023.5	—	23.50	0.9252	15.1
R95015/16	15/16	23.81	0.9375	15.4
R95024.0	—	24.00	0.9449	15.4
R95061/64	61/64	24.21	0.9531	15.4
R95024.5	—	24.50	0.9646	15.4
R95031/32	31/32	24.61	0.9688	15.4
R95025.0	—	25.00	0.9844	15.8
R95063/64	63/64	25.00	0.9844	15.8
R9501	1"	25.40	1.0000	15.8
R95025.5	—	25.50	1.0039	15.8
R95025.6	—	25.60	1.0079	15.8
R95025.65	—	25.65	1.0098	15.8
R9501.1/64	1.1/64	25.80	1.0156	15.8
R95026.0	—	26.00	1.0236	16.4
R9501.1/32	1.1/32	26.19	1.0313	16.4

Product	DC	DC	DC	LH
	(inch)	(mm)	(inch)	(mm)
R95026.5	—	26.50	1.0433	16.4
R9501.3/64	1.3/64	26.59	1.0469	16.4
R9501.1/16	1.1/16	26.99	1.0625	17.1
R95027.0	—	27.00	1.0630	17.1
R9501.5/64	1.5/64	27.38	1.0781	17.1
R95027.5	—	27.50	1.0827	17.1
R9501.3/32	1.3/32	27.78	1.0938	17.1
R95028.0	—	28.00	1.1024	17.7
R9501.7/64	1.7/64	28.18	1.1094	17.7
R95028.5	—	28.50	1.1220	17.7
R9501.1/8	1.1/8	28.58	1.1250	17.7
R9501.9/64	1.9/64	28.97	1.1406	18.3
R95029.0	—	29.00	1.1417	18.3
R9501.5/32	1.5/32	29.37	1.1563	18.3
R95029.5	—	29.50	1.1614	18.3
R9501.11/64	1.11/64	29.77	1.1719	18.3
R95030.0	—	30.00	1.1811	19.0
R9501.3/16	1.3/16	30.16	1.1875	19.0
R95030.5	—	30.50	1.2008	19.0
R9501.7/32	1.7/32	30.96	1.2188	21.0
R95031.0	—	31.00	1.2205	21.0
R9501.1/4	1.1/4	31.75	1.2500	21.0
R95032.0	—	32.00	1.2598	21.0
R95032.5	—	32.50	1.2795	21.0
R9501.19/64	1.19/64	32.94	1.2969	21.0
R95033.0	—	33.00	1.2992	21.0
R95033.5	—	33.50	1.3189	21.0
R95034.0	—	34.00	1.3386	23.0
R9501.11/32	1.11/32	34.13	1.3438	23.0
R95034.5	—	34.50	1.3583	23.0
R9501.3/8	1.3/8	34.93	1.3750	23.0
R95035.0	—	35.00	1.3780	23.0
R95036.0	—	36.00	1.4173	23.0
R9501.27/64	1.27/64	36.12	1.4219	23.0
R95036.5	—	36.50	1.4370	23.0
R95037.0	—	37.00	1.4567	25.0
R9501.15/32	1.15/32	37.31	1.4688	25.0
R95037.5	—	37.50	1.4764	25.0
R95038.0	—	38.00	1.4961	25.0
R9501.1/2	1.1/2	38.10	1.5000	25.0
R95038.5	—	38.50	1.5157	25.0
R9501.17/32	1.17/32	38.89	1.5313	25.0
R95039.0	—	39.00	1.5354	25.0
R95039.5	—	39.50	1.5551	25.0
R9501.9/16	1.9/16	39.69	1.5625	27.0
R95040.0	—	40.00	1.5748	27.0
R95041.0	—	41.00	1.6142	27.0
R9501.5/8	1.5/8	41.28	1.6250	27.0
R95042.0	—	42.00	1.6535	27.0



R960

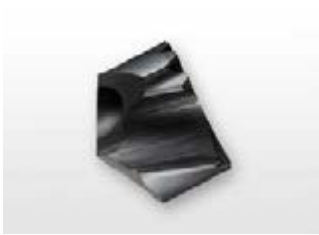

HYDRA Drill Head for Stainless Steels, Ti-phon Coated

Highly cost-effective and accurate design replaceable head for high performance in stainless steels. A 140° split point helps with self-centering and reduces cutting forces. Ti-phon coating prevents edge build-up and greatly improves chip flow, with superior wear resistance and edge strength.

HYDRA

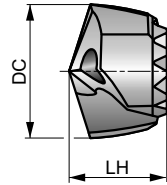

HM	DORMER	140°
Ti-phon	R	
DC h7		

Workpiece material group suitability, starting values for cutting speed (m/min) and feed Alpha Code. Tables with feed per revolution can be found starting from page XY.

P1.1 ■ 133 W	P1.2 ■ 148 W	P1.3 ■ 154 W	P2.1 ■ 114 W	M1.1 ■ 82 V	M1.2 ■ 70 V	M2.1 ■ 73 V	M2.2 ■ 60 V	M2.3 ▣ 50 T	M3.1 ■ 58 T	M3.2 ■ 50 T	M3.3 ■ 45 T	M4.1 ■ 40 T	M4.2 ▣ 34 T
K1.1 ■ 120 V	K1.2 ■ 89 V	K1.3 ■ 67 V	K2.1 ▣ 108 V	K2.2 ▣ 88 V	K2.3 ▣ 70 V	K3.1 ▣ 96 V	K3.2 ▣ 73 V	K3.3 ▣ 59 V	K4.1 ▣ 89 V	K4.2 ▣ 67 V	K4.3 ▣ 49 V	K4.4 ▣ 42 V	K4.5 ▣ 35 V
K5.1 ▣ 100 V	K5.2 ▣ 76 V	K5.3 ▣ 58 V	S1.1 ▣ 45 T	S1.2 ▣ 35 T	S1.3 ▣ 30 S	S2.1 ▣ 40 S	S2.2 ▣ 35 S	S3.1 ▣ 30 S	S3.2 ▣ 25 S	S4.1 ▣ 23 S	S4.2 ▣ 20 S		

Product	DC	DC	DC	LH
	(inch)	(mm)	(inch)	(mm)
R96015/32	15/32	11.91	0.4688	9.1
R96012.0	–	12.00	0.4724	9.1
R96012.1	–	12.10	0.4764	9.1
R96012.2	–	12.20	0.4803	9.1
R96031/64	31/64	12.30	0.4844	9.1
R96012.5	–	12.50	0.4921	9.4
R96012.6	–	12.60	0.4961	9.4
R9601/2	1/2	12.70	0.5000	9.4
R96012.8	–	12.80	0.5039	9.4
R96012.9	–	12.90	0.5079	9.4
R96013.0	–	13.00	0.5118	9.7
R96033/64	33/64	13.10	0.5156	9.7
R96013.2	–	13.20	0.5197	9.7
R96017/32	17/32	13.49	0.5313	9.7
R96013.5	–	13.50	0.5315	10.3
R96013.6	–	13.60	0.5354	10.3
R96013.7	–	13.70	0.5394	10.3
R96013.8	–	13.80	0.5433	10.3
R96035/64	35/64	13.89	0.5469	10.3
R96014.0	–	14.00	0.5512	10.3
R96014.1	–	14.10	0.5551	10.3
R96014.2	–	14.20	0.5591	10.3
R9609/16	9/16	14.29	0.5625	10.3
R96014.5	–	14.50	0.5709	10.3
R96014.6	–	14.60	0.5748	11.0
R96037/64	37/64	14.68	0.5781	11.0
R96014.7	–	14.70	0.5787	11.0
R96014.8	–	14.80	0.5827	11.0

Product	DC	DC	DC	LH
	(inch)	(mm)	(inch)	(mm)
R96015.0	–	15.00	0.5906	11.0
R96019/32	19/32	15.08	0.5938	11.0
R96015.1	–	15.10	0.5945	11.0
R96015.2	–	15.20	0.5984	11.0
R96015.24	–	15.24	0.6000	11.0
R96039/64	39/64	15.48	0.6094	11.0
R96015.5	–	15.50	0.6102	11.0
R96015.6	–	15.60	0.6142	11.6
R96015.7	–	15.70	0.6181	11.6
R9605/8	5/8	15.88	0.6250	11.6
R96016.0	–	16.00	0.6299	11.6
R96016.08	–	16.08	0.6331	11.6
R96016.1	–	16.10	0.6339	11.6
R96016.2	–	16.20	0.6378	11.6
R96041/64	41/64	16.27	0.6406	11.6
R96016.3	–	16.30	0.6417	11.6
R96016.5	–	16.50	0.6496	11.6
R96016.6	–	16.60	0.6535	12.2
R96021/32	21/32	16.67	0.6563	12.2
R96016.7	–	16.70	0.6575	12.2
R96017.0	–	17.00	0.6693	12.2
R96043/64	43/64	17.07	0.6719	12.2
R96017.1	–	17.10	0.6732	12.2
R96017.2	–	17.20	0.6772	12.2
R96011/16	11/16	17.46	0.6875	12.2
R96017.5	–	17.50	0.6890	12.2
R96017.6	–	17.60	0.6929	12.9
R96017.7	–	17.70	0.6969	12.9



Product	DC	DC	DC	LH
	(inch)	(mm)	(inch)	(mm)
R96045/64	45/64	17.86	0.7031	12.9
R96018.0	–	18.00	0.7087	12.9
R96018.1	–	18.10	0.7126	12.9
R96018.2	–	18.20	0.7165	12.9
R96023/32	23/32	18.26	0.7188	12.9
R96018.5	–	18.50	0.7283	12.9
R96018.6	–	18.60	0.7323	13.5
R96047/64	47/64	18.65	0.7344	13.5
R96018.7	–	18.70	0.7362	13.5
R96018.9	–	18.90	0.7441	13.5
R96019.0	–	19.00	0.7480	13.5
R9603/4	3/4	19.05	0.7500	13.5
R96019.1	–	19.10	0.7520	13.5
R96019.2	–	19.20	0.7559	13.5
R96019.25	–	19.25	0.7579	13.5
R96019.3	–	19.30	0.7598	13.5
R96019.35	–	19.35	0.7618	13.5
R96049/64	49/64	19.45	0.7656	13.5
R96019.5	–	19.50	0.7677	13.5
R96019.6	–	19.60	0.7717	14.1
R96019.7	–	19.70	0.7756	14.1
R96025/32	25/32	19.84	0.7813	14.1
R96020.0	–	20.00	0.7874	14.1
R96051/64	51/64	20.24	0.7969	14.1
R96020.5	–	20.50	0.8071	14.1
R96013/16	13/16	20.64	0.8125	14.8
R96021.0	–	21.00	0.8268	14.8
R96053/64	53/64	21.03	0.8281	14.8
R96027/32	27/32	21.43	0.8438	14.8
R96021.5	–	21.50	0.8465	14.8
R96055/64	55/64	21.83	0.8594	15.0
R96022.0	–	22.00	0.8661	15.0
R9607/8	7/8	22.22	0.8750	15.0
R96022.5	–	22.50	0.8858	15.0
R96057/64	57/64	22.62	0.8906	15.0
R96022.7	–	22.70	0.8937	15.0

Product	DC	DC	DC	LH
	(inch)	(mm)	(inch)	(mm)
R96023.0	–	23.00	0.9055	15.1
R96029/32	29/32	23.02	0.9063	15.1
R96059/64	59/64	23.42	0.9219	15.1
R96023.5	–	23.50	0.9252	15.1
R96015/16	15/16	23.81	0.9375	15.4
R96024.0	–	24.00	0.9449	15.4
R96061/64	61/64	24.21	0.9531	15.4
R96024.5	–	24.50	0.9646	15.4
R96031/32	31/32	24.61	0.9688	15.4
R96025.0	–	25.00	0.9844	15.8
R96063/64	63/64	25.00	0.9844	15.8
R9601	1"	25.40	1.0000	15.8
R96025.5	–	25.50	1.0039	15.8
R96025.65	–	25.65	1.0098	15.8
R9601.1/64	1.1/64	25.80	1.0156	15.8
R96026.0	–	26.00	1.0236	16.4
R9601.1/32	1.1/32	26.19	1.0313	16.4
R96026.5	–	26.50	1.0433	16.4
R9601.3/64	1.3/64	26.59	1.0469	16.4
R9601.1/16	1.1/16	26.99	1.0625	17.1
R96027.0	–	27.00	1.0630	17.1
R9601.5/64	1.5/64	27.38	1.0781	17.1
R96027.5	–	27.50	1.0827	17.1
R9601.3/32	1.3/32	27.78	1.0938	17.1
R96028.0	–	28.00	1.1024	17.7
R9601.7/64	1.7/64	28.18	1.1094	17.7
R96028.5	–	28.50	1.1220	17.7
R9601.1/8	1.1/8	28.58	1.1250	17.7
R9601.9/64	1.9/64	28.97	1.1406	18.3
R96029.0	–	29.00	1.1417	18.3
R9601.5/32	1.5/32	29.37	1.1563	18.3
R96029.5	–	29.50	1.1614	18.3
R9601.11/64	1.11/64	29.77	1.1719	18.3
R96030.0	–	30.00	1.1811	19.0
R9601.3/16	1.3/16	30.16	1.1875	19.0
R96030.5	–	30.50	1.2008	19.0



R970



HYDRA Drill Head for Cast Irons, Ti-phon Coated

Highly cost-effective and accurate design replaceable head for high performance in cast irons. A 140° split point helps with self-centering and reduces cutting forces. Ti-phon coating prevents edge build-up and greatly improves chip flow, with superior wear resistance and edge strength.

HYDRA

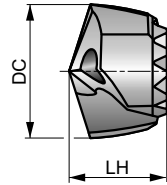

HM	DORMER	140°
Ti-phon	R	
DC h7		

Workpiece material group suitability, starting values for cutting speed (m/min) and feed Alpha Code. Tables with feed per revolution can be found starting from page XY.

K1.1 ■ 120 V	K1.2 ■ 89 V	K1.3 ■ 67 V	K2.1 ■ 98 V	K2.2 ■ 80 V	K2.3 ■ 64 V	K3.1 ■ 97 V	K3.2 ■ 67 V	K3.3 ■ 54 V	K4.1 ■ 81 V	K4.2 ■ 61 V	K4.3 ■ 45 V	K4.4 ■ 38 V	K4.5 ■ 32 V
K5.1 ■ 91 V	K5.2 ■ 69 V	K5.3 ■ 53 V											

Product	DC	DC	DC	LH
	(inch)	(mm)	(inch)	(mm)
R97015/32	15/32	11.91	0.4688	9.1
R97012.0	–	12.00	0.4724	9.1
R97012.1	–	12.10	0.4764	9.1
R97012.2	–	12.20	0.4803	9.1
R97031/64	31/64	12.30	0.4844	9.1
R97012.5	–	12.50	0.4921	9.4
R97012.6	–	12.60	0.4961	9.4
R9701/2	1/2	12.70	0.5000	9.4
R97012.8	–	12.80	0.5039	9.4
R97012.9	–	12.90	0.5079	9.4
R97013.0	–	13.00	0.5118	9.7
R97033/64	33/64	13.10	0.5156	9.7
R97013.2	–	13.20	0.5197	9.7
R97017/32	17/32	13.49	0.5313	9.7
R97013.5	–	13.50	0.5315	10.3
R97013.6	–	13.60	0.5354	10.3
R97013.7	–	13.70	0.5394	10.3
R97013.8	–	13.80	0.5433	10.3
R97035/64	35/64	13.89	0.5469	10.3
R97014.0	–	14.00	0.5512	10.3
R97014.1	–	14.10	0.5551	10.3
R97014.2	–	14.20	0.5591	10.3
R9709/16	9/16	14.29	0.5625	10.3
R97014.5	–	14.50	0.5709	10.3
R97014.6	–	14.60	0.5748	11.0
R97037/64	37/64	14.68	0.5781	11.0
R97014.7	–	14.70	0.5787	11.0
R97014.8	–	14.80	0.5827	11.0
R97015.0	–	15.00	0.5906	11.0
R97019/32	19/32	15.08	0.5938	11.0

Product	DC	DC	DC	LH
	(inch)	(mm)	(inch)	(mm)
R97015.1	–	15.10	0.5945	11.0
R97015.2	–	15.20	0.5984	11.0
R97015.24	–	15.24	0.6000	11.0
R97039/64	39/64	15.48	0.6094	11.0
R97015.5	–	15.50	0.6102	11.0
R97015.6	–	15.60	0.6142	11.6
R97015.7	–	15.70	0.6181	11.6
R9705/8	5/8	15.88	0.6250	11.6
R97016.0	–	16.00	0.6299	11.6
R97016.08	–	16.08	0.6331	11.6
R97016.1	–	16.10	0.6339	11.6
R97016.2	–	16.20	0.6378	11.6
R97041/64	41/64	16.27	0.6406	11.6
R97016.3	–	16.30	0.6417	11.6
R97016.5	–	16.50	0.6496	11.6
R97016.6	–	16.60	0.6535	12.2
R97021/32	21/32	16.67	0.6563	12.2
R97016.7	–	16.70	0.6575	12.2
R97017.0	–	17.00	0.6693	12.2
R97043/64	43/64	17.07	0.6719	12.2
R97017.1	–	17.10	0.6732	12.2
R97017.2	–	17.20	0.6772	12.2
R97011/16	11/16	17.46	0.6875	12.2
R97017.5	–	17.50	0.6890	12.2
R97017.6	–	17.60	0.6929	12.9
R97017.7	–	17.70	0.6969	12.9
R97045/64	45/64	17.86	0.7031	12.9
R97018.0	–	18.00	0.7087	12.9
R97018.1	–	18.10	0.7126	12.9
R97018.2	–	18.20	0.7165	12.9



Product	DC	DC	DC	LH
	(inch)	(mm)	(inch)	(mm)
R97023/32	23/32	18.26	0.7188	12.9
R97018.5	—	18.50	0.7283	12.9
R97018.6	—	18.60	0.7323	13.5
R97047/64	47/64	18.65	0.7344	13.5
R97018.7	—	18.70	0.7362	13.5
R97018.9	—	18.90	0.7441	13.5
R97019.0	—	19.00	0.7480	13.5
R9703/4	3/4	19.05	0.7500	13.5
R97019.1	—	19.10	0.7520	13.5
R97019.2	—	19.20	0.7559	13.5
R97019.25	—	19.25	0.7579	13.5
R97019.3	—	19.30	0.7598	13.5
R97019.35	—	19.35	0.7618	13.5
R97049/64	49/64	19.45	0.7656	13.5
R97019.5	—	19.50	0.7677	13.5
R97019.6	—	19.60	0.7717	14.1
R97019.7	—	19.70	0.7756	14.1
R97025/32	25/32	19.84	0.7813	14.1
R97020.0	—	20.00	0.7874	14.1
R97051/64	51/64	20.24	0.7969	14.1
R97020.5	—	20.50	0.8071	14.1
R97013/16	13/16	20.64	0.8125	14.8
R97021.0	—	21.00	0.8268	14.8
R97053/64	53/64	21.03	0.8281	14.8
R97027/32	27/32	21.43	0.8438	14.8
R97021.5	—	21.50	0.8465	14.8
R97055/64	55/64	21.83	0.8594	15.0
R97022.0	—	22.00	0.8661	15.0
R9707/8	7/8	22.22	0.8750	15.0
R97022.5	—	22.50	0.8858	15.0
R97057/64	57/64	22.62	0.8906	15.0
R97022.7	—	22.70	0.8937	15.0
R97023.0	—	23.00	0.9055	15.1
R97029/32	29/32	23.02	0.9063	15.1
R97059/64	59/64	23.42	0.9219	15.1
R97023.5	—	23.50	0.9252	15.1
R97015/16	15/16	23.81	0.9375	15.4
R97024.0	—	24.00	0.9449	15.4
R97061/64	61/64	24.21	0.9531	15.4
R97024.5	—	24.50	0.9646	15.4
R97031/32	31/32	24.61	0.9688	15.4
R97025.0	—	25.00	0.9844	15.8
R97063/64	63/64	25.00	0.9844	15.8
R9701	1"	25.40	1.0000	15.8
R97025.5	—	25.50	1.0039	15.8
R97025.65	—	25.65	1.0098	15.8
R9701.1/64	1.1/64	25.80	1.0156	15.8
R97026.0	—	26.00	1.0236	16.4
R9701.1/32	1.1/32	26.19	1.0313	16.4

Product	DC	DC	DC	LH
	(inch)	(mm)	(inch)	(mm)
R97026.5	—	26.50	1.0433	16.4
R9701.3/64	1.3/64	26.59	1.0469	16.4
R9701.1/16	1.1/16	26.99	1.0625	17.1
R97027.0	—	27.00	1.0630	17.1
R9701.5/64	1.5/64	27.38	1.0781	17.1
R97027.5	—	27.50	1.0827	17.1
R9701.3/32	1.3/32	27.78	1.0938	17.1
R97028.0	—	28.00	1.1024	17.7
R9701.7/64	1.7/64	28.18	1.1094	17.7
R97028.5	—	28.50	1.1220	17.7
R9701.1/8	1.1/8	28.58	1.1250	17.7
R9701.9/64	1.9/64	28.97	1.1406	18.3
R97029.0	—	29.00	1.1417	18.3
R9701.5/32	1.5/32	29.37	1.1563	18.3
R97029.5	—	29.50	1.1614	18.3
R9701.11/64	1.11/64	29.77	1.1719	18.3
R97030.0	—	30.00	1.1811	19.0
R9701.3/16	1.3/16	30.16	1.1875	19.0
R97030.5	—	30.50	1.2008	19.0
R9701.7/32	1.7/32	30.96	1.2188	21.0
R97031.0	—	31.00	1.2205	21.0
R9701.1/4	1.1/4	31.75	1.2500	21.0
R97032.0	—	32.00	1.2598	21.0
R97032.5	—	32.50	1.2795	21.0
R9701.19/64	1.19/64	32.94	1.2969	21.0
R97033.0	—	33.00	1.2992	21.0
R97033.5	—	33.50	1.3189	21.0
R97034.0	—	34.00	1.3386	23.0
R9701.11/32	1.11/32	34.13	1.3438	23.0
R97034.5	—	34.50	1.3583	23.0
R9701.3/8	1.3/8	34.93	1.3750	23.0
R97035.0	—	35.00	1.3780	23.0
R97036.0	—	36.00	1.4173	23.0
R9701.27/64	1.27/64	36.12	1.4219	23.0
R97036.5	—	36.50	1.4370	23.0
R97037.0	—	37.00	1.4567	25.0
R9701.15/32	1.15/32	37.31	1.4688	25.0
R97037.5	—	37.50	1.4764	25.0
R97038.0	—	38.00	1.4961	25.0
R9701.1/2	1.1/2	38.10	1.5000	25.0
R97038.5	—	38.50	1.5157	25.0
R9701.17/32	1.17/32	38.89	1.5313	25.0
R97039.0	—	39.00	1.5354	25.0
R97039.5	—	39.50	1.5551	25.0
R9701.9/16	1.9/16	39.69	1.5625	27.0
R97040.0	—	40.00	1.5748	27.0
R97041.0	—	41.00	1.6142	27.0
R9701.5/8	1.5/8	41.28	1.6250	27.0
R97042.0	—	42.00	1.6535	27.0



H851



HYDRA Body 1.5XD, with Coolant Feed, Bright Nickel Plating

Used with R950, R960 and R970 HYDRA heads. A range of head diameters can be used with the same body. Coolant holes aligned with the heads offer efficient cooling. Flanged shank prevents the drill from wandering in the holder. Nickel Plated surface protects from rust and corrosion, and improves chip evacuation.

HYDRA

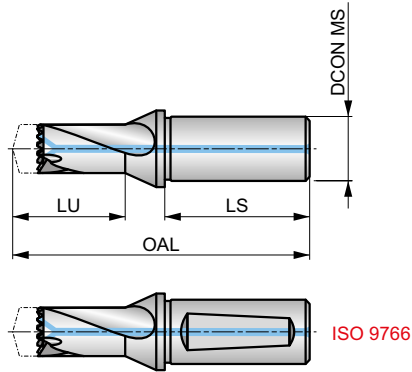

HSS	DORMER	1.5xD
Bright Ni	ISO 9766	R

Four (4) screws and one (1) screwdriver are included with a drill body, DCON MS tolerance h6.

Product	DCONMS	DCON MS	LU	OAL	LS	ADINTMS
	(inch)	(mm)	(mm)	(mm)	(mm)	
H85131/64	5/8	15.88	25.50	88.5	47.6	Cylindrical
H8511/2	5/8	15.88	25.80	88.8	47.6	Cylindrical
H85117/32	5/8	15.88	30.90	93.9	47.6	Cylindrical
H85112.0	—	16.00	25.50	88.5	48.0	ISO 9766
H85112.5	—	16.00	25.80	88.8	48.0	ISO 9766
H85113.0	—	16.00	27.00	90.0	48.0	ISO 9766
H85114.0	—	16.00	30.90	93.9	48.0	ISO 9766
H8519/16	3/4	19.05	30.30	93.9	50.8	Cylindrical
H85139/64	3/4	19.05	32.30	97.3	50.8	Cylindrical
H85141/64	3/4	19.05	34.90	99.9	50.8	Cylindrical
H85111/16	3/4	19.05	36.40	101.4	50.8	Cylindrical
H85123/32	3/4	19.05	39.00	104.0	50.8	Cylindrical
H85115.0	—	20.00	32.30	97.3	50.0	ISO 9766
H85116.0	—	20.00	34.90	99.9	50.0	ISO 9766
H85117.0	—	20.00	36.40	101.4	50.0	ISO 9766
H85118.0	—	20.00	39.00	104.0	50.0	ISO 9766
H85119.0	—	25.00	40.40	111.4	56.0	ISO 9766
H85120.0	—	25.00	43.00	114.0	56.0	ISO 9766
H85121.0	—	25.00	44.50	115.5	56.0	ISO 9766
H85122.0	—	25.00	46.10	117.1	56.0	ISO 9766
H85123.0	—	25.00	47.00	118.0	56.0	ISO 9766
H85149/64	1"	25.40	40.40	111.4	57.1	Cylindrical
H85151/64	1"	25.40	43.00	114.0	57.1	Cylindrical
H85127/32	1"	25.40	44.50	115.5	57.1	Cylindrical
H85157/64	1"	25.40	46.10	117.1	57.1	Cylindrical
H85159/64	1"	25.40	47.00	118.0	57.1	Cylindrical
H85131/32	1"	25.40	49.30	124.3	57.1	Cylindrical
H8511.1/64	1.1/4	31.75	49.70	124.7	60.3	Cylindrical
H8511.3/64	1.1/4	31.75	52.30	127.3	60.3	Cylindrical
H8511.3/32	1.1/4	31.75	52.80	127.8	60.3	Cylindrical
H8511.1/8	1.1/4	31.75	54.40	129.4	60.3	Cylindrical
H8511.11/64	1.1/4	31.75	55.80	130.8	60.3	Cylindrical
H8511.3/16	1.1/4	31.75	58.40	133.4	60.3	Cylindrical
H85124.0	—	32.00	49.30	124.3	60.0	ISO 9766



Product	DCONMS	DCON MS	LU	OAL	LS	ADINTMS
	(inch)	(mm)	(mm)	(mm)	(mm)	
H85125.0	–	32.00	49.70	124.7	60.0	ISO 9766
H85126.0	–	32.00	52.30	127.3	60.0	ISO 9766
H85127.0	–	32.00	52.80	127.8	60.0	ISO 9766
H85128.0	–	32.00	54.40	129.4	60.0	ISO 9766
H85129.0	–	32.00	55.80	130.8	60.0	ISO 9766
H85130.0	–	32.00	58.40	133.4	60.0	ISO 9766



H853



HYDRA Body 3XD, with Coolant Feed, Bright Nickel Plating

Used with R950, R960 and R970 HYDRA heads. A range of head diameters can be used with the same body. Coolant holes aligned with the heads offer efficient cooling. Bright Nickel Plated surface protects from rust and corrosion, and improves chip evacuation.

HYDRA

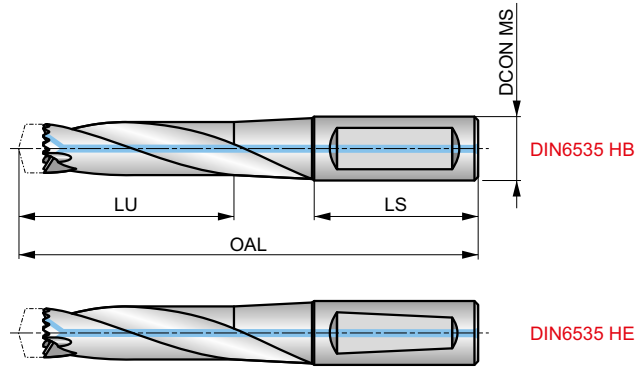

HSS	DORMER	3xD
Bright Ni	DIN 6535HB DIN 6535HE	R

Four (4) screws and one (1) screwdriver are included with a drill body, DCON MS tolerance h6.

Product	DCONMS	DCON MS	LU	OAL	LS	ADINTMS
	(inch)	(mm)	(mm)	(mm)	(mm)	
H85312.0	—	16.00	44.00	105.0	48.0	DIN6535HE
H85331/64	5/8	15.88	44.00	105.0	48.0	DIN6535HB
H85312.5	—	16.00	44.00	105.0	48.0	DIN6535HE
H8531/2	5/8	15.88	44.00	105.0	48.0	DIN6535HB
H85313.0	—	16.00	47.00	110.0	48.0	DIN6535HE
H85317/32	5/8	15.88	47.00	110.0	48.0	DIN6535HB
H85314.0	—	16.00	52.50	116.5	48.0	DIN6535HE
H8539/16	3/4	19.05	52.50	116.5	48.0	DIN6535HB
H85315.0	—	20.00	55.50	126.5	50.0	DIN6535HE
H85339/64	3/4	19.05	55.50	126.5	50.0	DIN6535HB
H85316.0	—	20.00	59.50	131.5	50.0	DIN6535HE
H85341/64	3/4	19.05	59.50	131.5	50.0	DIN6535HB
H85317.0	—	20.00	62.50	136.5	50.0	DIN6535HE
H85311/16	3/4	19.05	62.50	136.5	50.0	DIN6535HB
H85318.0	—	20.00	66.50	141.5	50.0	DIN6535HE
H85323/32	3/4	19.05	66.50	141.5	50.0	DIN6535HB
H85319.0	—	25.00	69.50	156.5	56.0	DIN6535HE
H85349/64	1"	25.40	69.50	156.5	56.0	DIN6535HB
H85320.0	—	25.00	73.50	156.5	56.0	DIN6535HE
H85351/64	1"	25.40	73.50	156.5	56.0	DIN6535HB
H85321.0	—	25.00	76.50	156.5	56.0	DIN6535HE
H85327/32	1"	25.40	76.50	156.5	56.0	DIN6535HB
H85322.0	—	25.00	80.10	161.5	56.0	DIN6535HE
H85357/64	1"	25.40	80.10	161.5	56.0	DIN6535HB
H85323.0	—	25.00	82.50	160.5	56.0	DIN6535HE
H85359/64	1"	25.40	82.50	160.5	56.0	DIN6535HB
H85324.0	—	32.00	86.20	170.2	60.0	DIN6535HE
H85331/32	1"	25.40	86.20	170.2	60.0	DIN6535HB
H85325.0	—	32.00	88.00	170.0	60.0	DIN6535HE
H8531.1/64	1.1/4	31.75	88.00	170.0	60.0	DIN6535HB
H85326.0	—	32.00	92.00	175.0	60.0	DIN6535HE
H8531.3/64	1.1/4	31.75	92.00	175.0	60.0	DIN6535HB
H85327.0	—	32.00	94.00	175.0	60.0	DIN6535HE
H8531.3/32	1.1/4	31.75	94.00	175.0	60.0	DIN6535HB



Product	DCONMS	DCON MS	LU	OAL	LS	ADINTMS
	(inch)	(mm)	(mm)	(mm)	(mm)	
H85328.0	–	32.00	97.00	180.0	60.0	DIN6535HE
H8531.1/8	1.1/4	31.75	97.00	180.0	60.0	DIN6535HB
H85329.0	–	32.00	100.00	185.0	60.0	DIN6535HE
H8531.11/64	1.1/4	31.75	100.00	185.0	60.0	DIN6535HB
H85330.0	–	32.00	104.00	185.0	60.0	DIN6535HE
H8531.3/16	1.1/4	31.75	104.00	185.0	60.0	DIN6535HB
H85332.0	–	32.00	111.50	196.5	60.0	DIN6535HE
H85333.5	–	32.00	116.50	201.5	60.0	DIN6535HE
H85335.0	–	40.00	121.50	216.5	70.0	DIN6535HB
H85336.5	–	40.00	125.50	221.5	70.0	DIN6535HB
H85338.0	–	40.00	131.50	226.5	70.0	DIN6535HB
H85339.5	–	40.00	136.50	231.5	70.0	DIN6535HB
H85341.0	–	40.00	146.50	246.5	70.0	DIN6535HB
H85342.5	–	40.00	151.60	251.6	70.0	DIN6535HB



H855



HYDRA Body 5XD, with Coolant Feed, Bright Nickel Plating

Used with R950, R960 and R970 HYDRA heads. A range of head diameters can be used with the same body. Coolant holes aligned with the heads offer efficient cooling. Bright Nickel Plated surface protects from rust and corrosion, and improves chip evacuation.

HYDRA

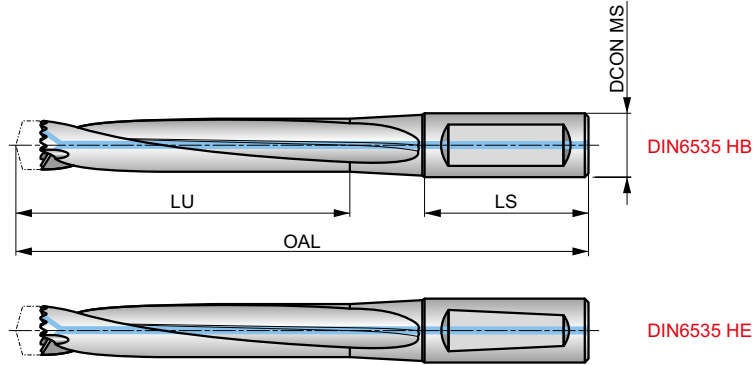

HSS	DORMER	5xD
Bright Ni	DIN 6535HB DIN 6535HE	R

Four (4) screws and one (1) screwdriver are included with a drill body, DCON MS tolerance h6.

Product	DCONMS	DCON MS	LU	OAL	LS	ADINTMS
	(inch)	(mm)	(mm)	(mm)	(mm)	
H85512.0	—	16.00	69.00	130.0	48.0	DIN6535HE
H85531/64	5/8	15.88	69.00	130.0	48.0	DIN6535HB
H85512.5	—	16.00	69.00	130.0	48.0	DIN6535HE
H8551/2	5/8	15.88	69.00	130.0	48.0	DIN6535HB
H85513.0	—	16.00	74.00	140.0	48.0	DIN6535HE
H85517/32	5/8	15.88	74.00	140.0	48.0	DIN6535HB
H85514.0	—	16.00	81.50	146.5	48.0	DIN6535HE
H8559/16	3/4	19.05	81.50	146.5	48.0	DIN6535HB
H85515.0	—	20.00	86.50	156.5	50.0	DIN6535HE
H85539/64	3/4	19.05	86.50	156.5	50.0	DIN6535HB
H85516.0	—	20.00	92.50	166.5	50.0	DIN6535HE
H85541/64	3/4	19.05	92.50	166.5	50.0	DIN6535HB
H85517.0	—	20.00	97.50	171.5	50.0	DIN6535HE
H85511/16	3/4	19.05	97.50	171.5	50.0	DIN6535HB
H85518.0	—	20.00	103.50	176.5	50.0	DIN6535HE
H85523/32	3/4	19.05	103.50	176.5	50.0	DIN6535HB
H85519.0	—	25.00	108.50	191.5	56.0	DIN6535HE
H85549/64	1"	25.40	108.50	191.5	56.0	DIN6535HB
H85520.0	—	25.00	114.50	196.5	56.0	DIN6535HE
H85551/64	1"	25.40	114.50	196.5	56.0	DIN6535HB
H85521.0	—	25.00	119.50	196.5	56.0	DIN6535HE
H85527/32	1"	25.40	119.50	196.5	56.0	DIN6535HB
H85522.0	—	25.00	125.10	201.1	56.0	DIN6535HE
H85557/64	1"	25.40	125.10	201.1	56.0	DIN6535HB
H85523.0	—	25.00	129.50	210.5	56.0	DIN6535HE
H85559/64	1"	25.40	129.50	210.5	56.0	DIN6535HB
H85524.0	—	32.00	135.20	220.2	60.0	DIN6535HE
H85531/32	1"	25.40	135.20	220.2	60.0	DIN6535HB
H85525.0	—	32.00	140.00	225.0	60.0	DIN6535HE
H8551.1/64	1.1/4	31.75	140.00	225.0	60.0	DIN6535HB
H85526.0	—	32.00	146.00	230.0	60.0	DIN6535HE
H8551.3/64	1.1/4	31.75	146.00	230.0	60.0	DIN6535HB
H85527.0	—	32.00	151.00	235.0	60.0	DIN6535HE
H8551.3/32	1.1/4	31.75	151.00	235.0	60.0	DIN6535HB



Product	DCONMS	DCON MS	LU	OAL	LS	ADINTMS
	(inch)	(mm)	(mm)	(mm)	(mm)	
H85528.0	–	32.00	157.00	240.0	60.0	DIN6535HE
H8551.1/8	1.1/4	31.75	157.00	240.0	60.0	DIN6535HB
H85529.0	–	32.00	162.00	245.0	60.0	DIN6535HE
H8551.11/64	1.1/4	31.75	162.00	245.0	60.0	DIN6535HB
H85530.0	–	32.00	167.00	255.0	60.0	DIN6535HE
H8551.3/16	1.1/4	31.75	167.00	255.0	60.0	DIN6535HB
H85532.0	–	32.00	176.50	261.5	60.0	DIN6535HE
H85533.5	–	32.00	186.50	271.5	60.0	DIN6535HE
H85535.0	–	40.00	196.50	291.5	70.0	DIN6535HB
H85536.5	–	40.00	201.50	296.5	70.0	DIN6535HB
H85538.0	–	40.00	211.50	306.5	70.0	DIN6535HB
H85539.5	–	40.00	221.50	316.5	70.0	DIN6535HB
H85541.0	–	40.00	226.50	325.6	70.0	DIN6535HB
H85542.5	–	40.00	236.50	336.5	70.0	DIN6535HB



H858



HYDRA Body 8XD, with Coolant Feed, Bright Nickel Plating

Used with R950, R960 and R970 HYDRA heads. A range of head diameters can be used with the same body. Coolant holes aligned with the heads offer efficient cooling. Bright Nickel Plated surface protects from rust and corrosion, and improves chip evacuation.

HYDRA

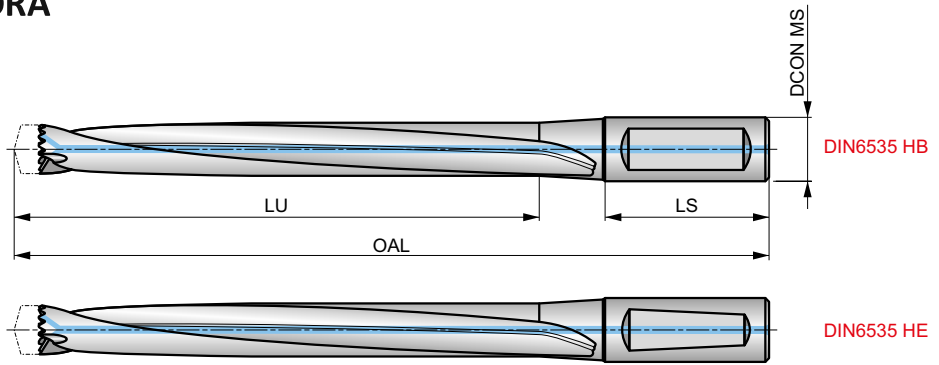

HSS	DORMER	8xD
Bright Ni	DIN 6535HB DIN 6535HE	R

Four (4) screws and one (1) screwdriver are included with a drill body, DCON MS tolerance h6.

Product	DCON MS (mm)	LU (mm)	OAL (mm)	LS (mm)	ADINTMS
H85814.0	16.00	124.50	191.5	48.0	DIN6535HE
H85815.0	20.00	133.50	201.5	50.0	DIN6535HE
H85816.0	20.00	141.50	211.5	50.0	DIN6535HE
H85817.0	20.00	150.50	221.5	50.0	DIN6535HE
H85818.0	20.00	158.50	226.5	50.0	DIN6535HE
H85819.0	25.00	167.50	251.5	56.0	DIN6535HE
H85820.0	25.00	175.50	264.5	56.0	DIN6535HE
H85821.0	25.00	184.50	266.5	56.0	DIN6535HE
H85822.0	25.00	192.10	271.1	56.0	DIN6535HE
H85823.0	25.00	200.50	280.5	56.0	DIN6535HE
H85824.0	32.00	208.20	295.2	60.0	DIN6535HE
H85825.0	32.00	217.00	300.0	60.0	DIN6535HE
H85826.0	32.00	225.00	310.0	60.0	DIN6535HE
H85827.0	32.00	234.00	320.0	60.0	DIN6535HE
H85828.0	32.00	242.00	325.0	60.0	DIN6535HE
H85829.0	32.00	251.00	335.0	60.0	DIN6535HE
H85830.0	32.00	259.00	345.0	60.0	DIN6535HE
H85832.0	32.00	271.50	356.5	60.0	DIN6535HE
H85833.5	32.00	286.50	371.5	60.0	DIN6535HE
H85835.0	40.00	301.50	396.5	70.0	DIN6535HB
H85836.5	40.00	311.50	406.5	70.0	DIN6535HB
H85838.0	40.00	326.50	421.5	70.0	DIN6535HB
H85839.5	40.00	336.50	431.5	70.0	DIN6535HB
H85841.0	40.00	351.50	451.5	70.0	DIN6535HB
H85842.5	40.00	361.50	461.5	70.0	DIN6535HB



H8512



HYDRA Body 12XD, with Coolant Feed, Bright Nickel Plating

Used with R950, R960 and R970 HYDRA heads. A range of head diameters can be used with the same body. Coolant holes aligned with the heads offer efficient cooling. Flanged shank prevents the drill from wandering in the holder. Nickel Plated surface protects from rust and corrosion, and improves chip evacuation.

HYDRA

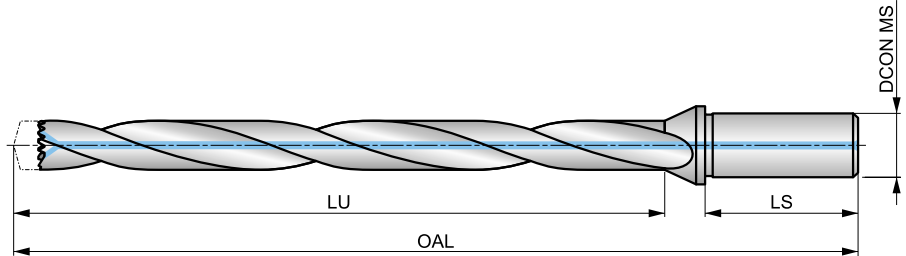

HSS	DORMER	12xD
Bright Ni		R

Four (4) screws and one (1) screwdriver are included with a drill body, DCON MS tolerance h6.

Product	DCON MS	LU	OAL	LS
	(mm)	(mm)	(mm)	(mm)
H851214.0	16.00	168.00	236.0	48.0
H851215.0	20.00	180.00	250.3	50.0
H851216.0	20.00	192.00	262.6	50.0
H851217.0	20.00	204.00	275.0	50.0
H851218.0	20.00	216.00	287.2	50.0
H851219.0	25.00	228.00	305.6	56.0
H851220.0	25.00	240.00	317.8	56.0
H851221.0	25.00	252.00	330.1	56.0
H851222.0	25.00	264.00	343.0	56.0
H851223.0	25.00	276.00	354.8	56.0
H851224.0	32.00	288.00	371.7	60.0
H851225.0	32.00	300.00	383.8	60.0



H860



HYDRA Screws

Replacement screws used to securely hold HYDRA heads in place.

HYDRA

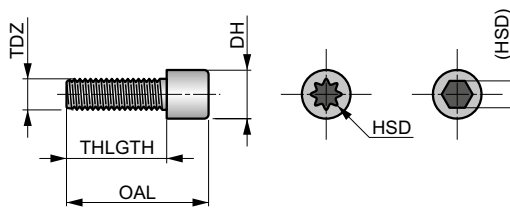

Product	Nr.	TDZ	OAL	THLGTH	DH	HSD
			(mm)	(mm)	(mm)	
H860N1	1	M2.2	7.5	5.70	3.5	8IP
H860N2	2	M2.5	9.0	7.00	4.1	10IP
H860N3	3	M3.0	10.5	8.00	4.9	15IP
H860N4	4	M3.5	11.5	8.80	5.5	15IP
H860N5	5	M4.0	12.5	9.50	6.0	20IP
H860N6	6	M4.5	14.3	10.80	6.8	25IP
H860N7	7	M5.0	20.0	15.00	8.5	4



H861

HYDRA Screw Driver
Screwdrivers used to tighten HYDRA screws.





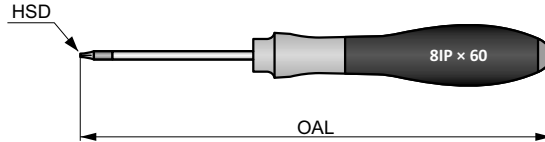







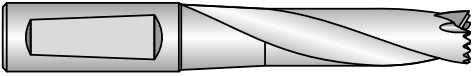



HYDRA



Product	Nr.	HSD	OAL
			(mm)
H861N1	N1	8IP	164.0
H861N2	N2	10IP	191.0
H861N3	N3	15IP	191.0
H861N4	N4	20IP	218.0
H861N5	N5	25IP	218.0
H861N6	N6	4	186.0



HIGH PERFORMANCE REPLACEABLE HEAD DRILLS

SetUp										
DC	H851 1.5xD	H853 3xD	H855 5xD	H858 8xD	H8512 12xD	R950	R960	R970	H860	H861
										
Range	12.00 – 30.50 15/32" – 1.3/16"	12.00 – 42.50 15/32" – 1.5/8"	12.00 – 42.50 15/32" – 1.5/8"	13.50 – 42.50 35/64" – 1.5/8"	13.50 – 25.65 35/64" – 1.1/64"	12.00 – 42.00 15/32" – 1.5/8"	12.00 – 30.50 15/32" – 1.3/16"	12.00 – 42.00 15/32" – 1.5/8"	N1 – N7	N1 – N6
Pages	494	496	498	500	501	488	490	492	502	503

DC	H851 1.5xD	H853 3xD	H855 5xD	H858 8xD	H8512 12xD	R950	R960	R970	H860	H861
15/32"						R95015/32	R96015/32	R97015/32		
12.0	H85112.0	H85312.0	H85512.0	–	–	R95012.0	R96012.0	R97012.0		
12.1	H85131/64	H85331/64	H85531/64			R95012.1	R96012.1	R97012.1		
12.2						R95012.2	R96012.2	R97012.2		
31/64"						R95031/64	R96031/64	R97031/64		
12.5						R95012.5	R96012.5	R97012.5		
12.6	H85112.5	H85312.5	H85512.5	–	–	R95012.6	R96012.6	R97012.6		
1/2"	H8511/2	H8531/2	H8551/2			R9501/2	R9601/2	R9701/2		
12.8						R95012.8	R96012.8	R97012.8		
12.9						R95012.9	R96012.9	R97012.9		
13.0						R95013.0	R96013.0	R97013.0		
33/64"	H85113.0	H85313.0	H85513.0	–	–	R95033/64	R96033/64	R97033/64		
13.2	H85117/32	H85317/32	H85517/32			R95013.2	R96013.2	R97013.2		
17/32"						R95017/32	R96017/32	R97017/32		
13.5						R95013.5	R96013.5	R97013.5		
13.6						R95013.6	R96013.6	R97013.6		
13.7						R95013.7	R96013.7	R97013.7		
13.8						R95013.8	R96013.8	R97013.8		
35/64"	H85114.0	H85314.0	H85514.0	H85814.0	H851214.0	R95035/64	R96035/64	R97035/64	H860N1	H861N1
14.0	H8519/16	H8539/16	H8559/16			R95014.0	R96014.0	R97014.0		
14.1						R95014.1	R96014.1	R97014.1		
14.2						R95014.2	R96014.2	R97014.2		
9/16"						R9509/16	R9609/16	R9709/16		
14.5						R95014.5	R96014.5	R97014.5		
14.6						R95014.6	R96014.6	R97014.6		
37/64"						R95037/64	R96037/64	R97037/64		
14.7						R95014.7	R96014.7	R97014.7		
14.8						R95014.8	R96014.8	R97014.8		
15.0						R95015.0	R96015.0	R97015.0		
19/32"	H85115.0	H85315.0	H85515.0	H85815.0	H851215.0	R95019/32	R96019/32	R97019/32		
15.1	H85139/64	H85339/64	H85539/64			R95015.1	R96015.1	R97015.1		
15.2						R95015.2	R96015.2	R97015.2		
15.24						R95015.24	R96015.24	R97015.24		
39/64"						R95039/64	R96039/64	R97039/64		
15.5						R95015.5	R96015.5	R97015.5		



HIGH PERFORMANCE REPLACEABLE HEAD DRILLS

DC	H851 1.5xD	H853 3xD	H855 5xD	H858 8xD	H8512 12xD	R950	R960	R970	H860	H861							
15.6	H85116.0 H85141/64	H85316.0 H85341/64	H85516.0 H85541/64	H85816.0	H851216.0	R95015.6	R96015.6	R97015.6	H860N2	H861N2							
15.7						R95015.7	R96015.7	R97015.7									
5/8"						R9505/8	R9605/8	R9705/8									
16.0						R95016.0	R96016.0	R97016.0									
16.08						R95016.08	R96016.08	R97016.08									
16.1						R95016.1	R96016.1	R97016.1									
16.2						R95016.2	R96016.2	R97016.2									
16.3						R95016.3	R96016.3	R97016.3									
41/64"						R95041/64	R96041/64	R97041/64									
16.5						R95016.5	R96016.5	R97016.5									
16.6	H85117.0 H85111/16	H85317.0 H85311/16	H85517.0 H85511/16	H85817.0	H851217.0	R95016.6	R96016.6	R97016.6	H860N2	H861N2							
21/32"						R95021/32	R96021/32	R97021/32									
16.7						R95016.7	R96016.7	R97016.7									
17.0						R95017.0	R96017.0	R97017.0									
43/64"						R95043/64	R96043/64	R97043/64									
17.1						R95017.1	R96017.1	R97017.1									
17.2						R95017.2	R96017.2	R97017.2									
11/16"						R95011/16	R96011/16	R97011/16									
17.5						R95017.5	R96017.5	R97017.5									
17.6						H85118.0 H85123/32	H85318.0 H85323/32	H85518.0 H85523/32			H85818.0	H851218.0	R95017.6	R96017.6	R97017.6	H860N3	H861N3
17.7	R95017.7	R96017.7	R97017.7														
45/64"	R95045/64	R96045/64	R97045/64														
18.0	R95018.0	R96018.0	R97018.0														
18.1	R95018.1	R96018.1	R97018.1														
18.2	R95018.2	R96018.2	R97018.2														
23/32"	R95023/32	R96023/32	R97023/32														
18.5	R95018.5	R96018.5	R97018.5														
18.6	H85119.0 H85149/64	H85319.0 H85349/64	H85519.0 H85549/64	H85819.0	H851219.0				R95018.6	R96018.6			R97018.6	H860N3	H861N3		
47/64"									R95047/64	R96047/64			R97047/64				
18.7						R95018.7	R96018.7	R97018.7									
18.9						R95018.9	R96018.9	R97018.9									
19.0						R95019.0	R96019.0	R97019.0									
3/4"						R9503/4	R9603/4	R9703/4									
19.1						R95019.1	R96019.1	R97019.1									
19.2						R95019.2	R96019.2	R97019.2									
19.25						R95019.25	R96019.25	R97019.25									
19.3						R95019.3	R96019.3	R97019.3									
19.35	R95019.35	R96019.35	R97019.35														
49/64"	R95049/64	R96049/64	R97049/64														
19.5	R95019.5	R96019.5	R97019.5														
19.6	H85120.0 H85151/64	H85320.0 H85351/64	H85520.0 H85551/64	H85820.0	H851220.0	R95019.6	R96019.6	R97019.6	H860N4	H861N3							
19.7						R95019.7	R96019.7	R97019.7									
25/32"						R95025/32	R96025/32	R97025/32									
20.0						R95020.0	R96020.0	R97020.0									
51/64"						R95051/64	R96051/64	R97051/64									
20.5						R95020.5	R96020.5	R97020.5									
13/16"						R95013/16	R96013/16	R97013/16									
21.0						R95021.0	R96021.0	R97021.0									
53/64"						R95053/64	R96053/64	R97053/64									
27/32"						R95027/32	R96027/32	R97027/32									
21.5	R95021.5	R96021.5	R97021.5														
55/64"	H85122.0 H85157/64	H85322.0 H85357/64	H85522.0 H85557/64	H85822.0	H851222.0	R95055/64	R96055/64	R97055/64	H860N4	H861N3							
22.0						R95022.0	R96022.0	R97022.0									
7/8"						R9507/8	R9607/8	R9707/8									
22.5						R95022.5	R96022.5	R97022.5									
57/64"						R95057/64	R96057/64	R97057/64									
22.7						R95022.7	R96022.7	R97022.7									
23.0						H85123.0 H85159/64	H85323.0 H85359/64	H85523.0 H85559/64			H85823.0	H851223.0	R95023.0	R96023.0	R97023.0	H860N4	H861N3
29/32"													R95029/32	R96029/32	R97029/32		
59/64"													R95059/64	R96059/64	R97059/64		
23.5													R95023.5	R96023.5	R97023.5		



HIGH PERFORMANCE REPLACEABLE HEAD DRILLS

DC	H851 1.5xD	H853 3xD	H855 5xD	H858 8xD	H8512 12xD	R950	R960	R970	H860	H861
15/16	H85124.0 H85131/32	H85324.0 H85331/32	H85524.0 H85531/32	H85824.0	H851224.0	R95015/16	R96015/16	R97015/16	H860N4	H861N3
24.0						R95024.0	R96024.0	R97024.0		
61/64						R95061/64	R96061/64	R97061/64		
24.5						R95024.5	R96024.5	R97024.5		
31/32"						R95031/32	R96031/32	R97031/32		
25.0	H85125.0 H8511.1/64	H85325.0 H8531.1/64	H85525.0 H8551.1/64	H85825.0	H851225.0	R95025.0	R96025.0	R97025.0	H860N5	H861N4
63/64"						R95063/64	R96063/64	R97063/64		
1"						R9501	R9601	R9701		
25.5						R95025.5	R96025.5	R97025.5		
25.6						R95025.6	–	–		
25.65						R95025.65	R96025.65	R97025.65		
1.1/64"						R9501.1/64	R9601.1/64	R9701.1/64		
26.0						R95026.0	R96026.0	R97026.0		
1.1/32"						R9501.1/32	R9601.1/32	R9701.1/32		
26.5						R95026.5	R96026.5	R97026.5		
1.3/64	R9501.3/64	R9601.3/64	R9701.3/64							
1.1/16"	H85127.0 H8511.3/32	H85327.0 H8531.3/32	H85527.0 H8551.3/32	H85827.0	–	R9501.1/16	R9601.1/16	R9701.1/16	H860N6	H861N5
27.0						R95027.0	R96027.0	R97027.0		
1.5/64"						R9501.5/64	R9601.5/64	R9701.5/64		
27.5						R95027.5	R96027.5	R97027.5		
1.3/32"						R9501.3/32	R9601.3/32	R9701.3/32		
28.0	H85128.0 H8511.1/8	H85328.0 H8531.1/8	H85528.0 H8551.1/8	H85828.0	–	R95028.0	R96028.0	R97028.0	H860N7	H861N6
1.7/64"						R9501.7/64	R9601.7/64	R9701.7/64		
28.5						R95028.5	R96028.5	R97028.5		
1.1/8"						R9501.1/8	R9601.1/8	R9701.1/8		
1.9/64"	H85129.0 H8511.11/64	H85329.0 H8531.11/64	H85529.0 H8551.11/64	H85829.0	–	R9501.9/64	R9601.9/64	R9701.9/64	H860N8	H861N7
29.0						R95029.0	R96029.0	R97029.0		
1.5/32"						R9501.5/32	R9601.5/32	R9701.5/32		
29.5						R95029.5	R96029.5	R97029.5		
1.11/64"						R9501.11/64	R9601.11/64	R9701.11/64		
30.0	H85130.0 H8511.3/16	H85330.0 H8531.3/16	H85530.0 H8551.3/16	H85830.0	–	R95030.0	R96030.0	R97030.0	H860N9	H861N8
1.3/16"						R9501.3/16	R9601.3/16	R9701.3/16		
30.5						R95030.5	R96030.5	R97030.5		
1.7/32"	–	H85332.0	H85532.0	H85832.0	–	R9501.7/32	–	R9701.7/32	H860N10	H861N9
31.0						R95031.0	–	R97031.0		
1.1/4"						R9501.1/4	–	R9701.1/4		
32.0						R95032.0	–	R97032.0		
32.5	–	H85333.5	H85533.5	H85833.5	–	R95032.5	–	R97032.5	H860N11	H861N10
1.19/64"						R9501.19/64	–	R9701.19/64		
33.0						R95033.0	–	R97033.0		
33.5						R95033.5	–	R97033.5		
34.0	–	H85335.0	H85535.0	H85835.0	–	R95034.0	–	R97034.0	H860N12	H861N11
1.11/32"						R9501.11/32	–	R9701.11/32		
34.5						R95034.5	–	R97034.5		
1.3/8"						R9501.3/8	–	R9701.3/8		
35.0						R95035.0	–	R97035.0		
36.0	–	H85336.5	H85536.5	H85836.5	–	R95036.0	–	R97036.0	H860N13	H861N12
1.27/64"						R9501.27/64	–	R9701.27/64		
36.5						R95036.5	–	R97036.5		
37.0	–	H85338.0	H85538.0	H85838.0	–	R95037.0	–	R97037.0	H860N14	H861N13
1.15/32"						R9501.15/32	–	R9701.15/32		
37.5						R95037.5	–	R97037.5		
38.0						R95038.0	–	R97038.0		
1.1/2"	–	H85339.5	H85539.5	H85839.5	–	R9501.1/2	–	R9701.1/2	H860N15	H861N14
38.5						R95038.5	–	R97038.5		
1.17/32"						R9501.17/32	–	R9701.17/32		
39.0						R95039.0	–	R97039.0		
39.5						R95039.5	–	R97039.5		
1.9/16"	–	H85341.0	H85541.0	H85841.0	–	R9501.9/16	–	R9701.9/16	H860N16	H861N15
40.0						R95040.0	–	R97040.0		
41.0						R95041.0	–	R97041.0		



HIGH PERFORMANCE REPLACEABLE HEAD DRILLS

DC	H851 1.5×D	H853 3×D	H855 5×D	H858 8×D	H8512 12×D	R950	R960	R970	H860	H861
1.5/8" 42.0	–	H85342.5	H85542.5	H85842.5	–	R9501.5/8 R95042.0	– –	R9701.5/8 R97042.0	H860N7	H861N6

Accessories

H860	H861	Hydra Head DC range			Wrench Size / Bit
		Metric (min. – max.)	Fractional (min. – max.)	Decimal (min. – max.)	
H860N1	H861N1	12.0 mm – 15.5 mm	15/32" – 39/64"	0.4688" – 0.6102"	8IP
H860N2	H861N2	15.6 mm – 18.5 mm	5/8" – 23/32"	0.6142" – 0.7283"	10IP
H860N3	H861N3	18.6 mm – 21.5 mm	47/64" – 27/32"	0.7323" – 0.8465"	15IP
H860N4	H861N3	22.0 mm – 24.5 mm	55/64" – 31/32"	0.8594" – 0.9688"	15IP
H860N5	H861N4	25.0 mm – 27.5 mm	63/64" – 1-3/32"	0.9843" – 1.0938"	20IP
H860N6	H861N5	28.0 mm – 33.5 mm	1-7/64" – 1-19/64"	1.1024" – 1.3189"	25IP
H860N7	H861N6	34.0 mm – 42.0 mm	1-11/32" – 1-5/8"	1.3386" – 1.6535"	4 mm

CUTTING CONDITIONS CORRECTION FACTORS (BASED ON HYDRA BODY LENGTHS)

H851	Apply starting values for speed and feed with a correction factor of 1.10
H853	Apply starting values for speed and feed with a correction factor of 1.00
H855	Apply starting values for speed and feed with a correction factor of 0.95
H858	Apply starting values for speed and feed with a correction factor of 0.90
H8512	Apply starting values for speed and feed with a correction factor of 0.80



HYDRA – TECHNICAL INFO

Torque table

H860	H861	Hydra Head \varnothing Metric Range	Hydra Head \varnothing Fractional Range	Hydra Head \varnothing Decimal Size Range (min. / max.)	Torque Values Nm (Metric System)	Torque Values in/lbs (Inch System)
H860N1	H861N1	12.0 mm – 15.5 mm	15/32" – 39/64"	0.4688" – 0.6102"	0.75 – 0.99	6.6 – 8.8
H860N2	H861N2	15.6 mm – 18.5 mm	5/8" – 23/32"	0.6142" – 0.7283"	0.93 – 1.24	8.2 – 11.0
H860N3	H861N3	18.6 mm – 21.5 mm	47/64" – 27/32"	0.7323" – 0.8465"	1.84 – 2.44	16.3 – 21.6
H860N4	H861N3	22.0 mm – 24.5 mm	55/64" – 31/32"	0.8594" – 0.9688"	2.73 – 3.72	24.2 – 32.9
H860N5	H861N4	25.0 mm – 27.5 mm	63/64" – 1-3/32"	0.9843" – 1.0938"	4.14 – 5.52	36.6 – 48.8
H860N6	H861N5	28.0 mm – 33.5 mm	1-7/64" – 1-19/64"	1.1024" – 1.3189"	4.97 – 6.63	44.0 – 58.7
H860N7	H861N6	34.0 mm – 42.0 mm	1-11/32" – 1-5/8"	1.3386" – 1.6535"	7.2	63.7

Screws and screw-driver data

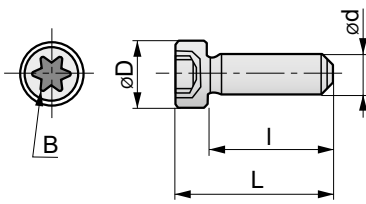

e-code	d	Pitch	L (mm)	I (mm)	D (mm)	B
H860N1	M2.2	0.45	7.5	5.7	3.5	8IP
H860N2	M2.5	0.45	9.0	7.0	4.1	10IP
H860N3	M3.0	0.50	10.5	8.0	4.9	15IP
H860N4	M3.5	0.60	11.5	8.8	5.5	15IP
H860N5	M4.0	0.70	12.5	9.5	6.0	20IP
H860N6	M4.5	0.75	14.3	10.8	6.8	25IP

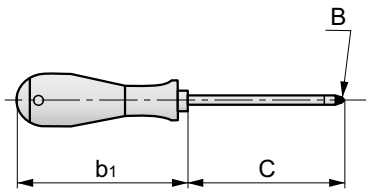

e-code	B	C	b ₁
H861N1	8IP	60	104
H861N2	10IP	80	111
H861N3	15IP	80	111
H861N4	20IP	100	118
H861N5	25IP	100	118

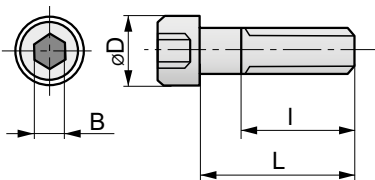

e-code	d	Pitch	L (mm)	I (mm)	D (mm)	B
H860N7	M5.0	0.8	15	full	8.5	4

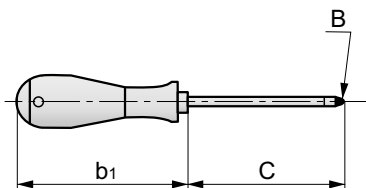

e-code	B	C	b ₁
H861N6	4	75	111



Apply special programming for 8xD and 12xD drilling

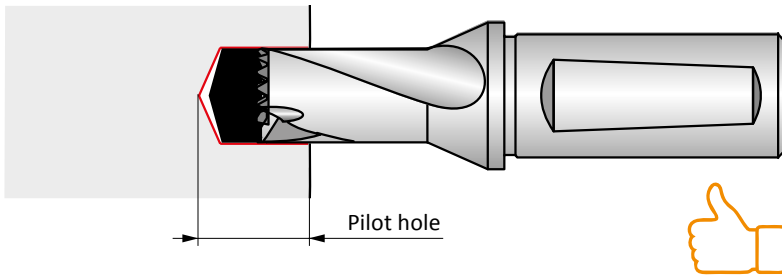

Drill a pilot hole (1.5xD to 3xD depth) with the same HYDRA head diameter (if needed check the runout of the drill max. +/- 0.05 mm).

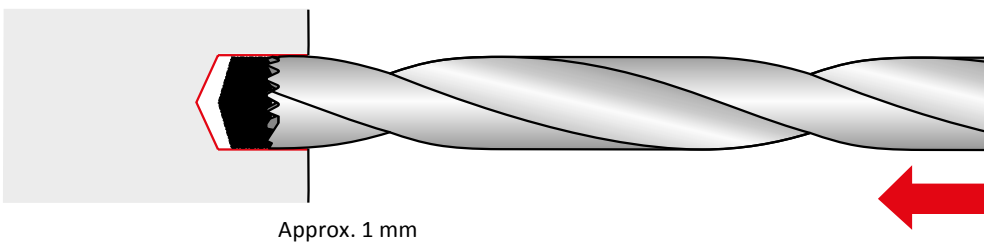

Enter the pilot hole with the 8xD or 12xD Body running a maximum of 500 rpm, to approximately 1mm above the pre-drilled pilot hole depth.

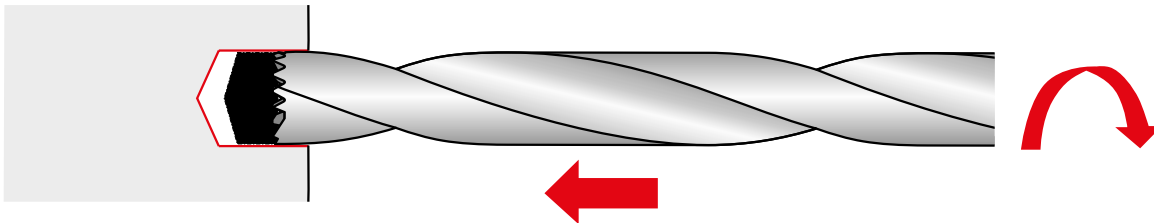

Start coolant flow and increase the rotational speed up to the recommended RPM.

Note: Apply a short dwell time don't start the feed before recommended RPM is reached.

Drill without pecking to the required depth.

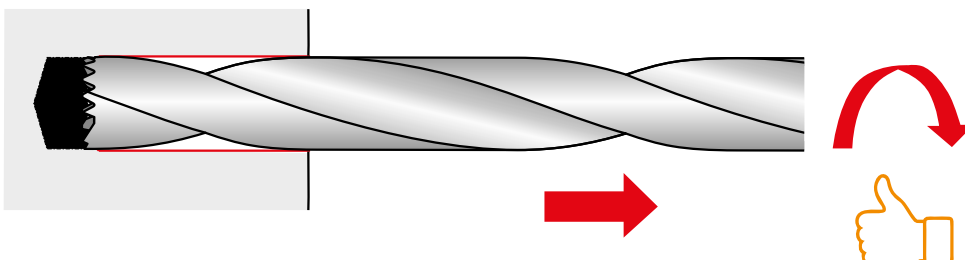

When the required depth is reached, retract the drill by approximately 0.1 mm to 0.5 mm and reduce to 500 rpm followed by a complete retraction with normal feed. **Note: retracting the drill with a higher spindle speed may cause a shoulder damage from run out or destroy the hole surface and tolerance.**



Drilling hints & tips with the hydra drill

Coolants

For maximum chip evacuation and tool performance, coolant use is recommended. Emulsion coolant concentration of 6 – 8% is recommended for most applications, with a coolant pressure of 20 bar (290 PSI) or higher. For high strength steel, stainless steels and tougher drilling applications, use a higher concentration of 10– 12%. In these applications, particularly in stainless steels, it is recommended to use the maximum coolant pressure on the machine. The Hydra-drill coolant holes provide improved web strength and reduce heat at the cutting edges for increased productivity and longer tool life.

HOLDERS

Always use tool holders and collets that provide good concentricity

between the drill and the machine spindle. Use a positive stop to prevent the tool from backing up into the holder. Radial runout in the tool assembly must be accurately checked and maintained.

Workpiece

A secure and rigid workpiece will minimise deflection, and allow for better accuracy and true position of the hole.

Feeds

It is important not to underfeed the drill which will cause it to dwell and dull. This is particularly true in work hardening materials. Feed rates should be high enough for proper chip formation.

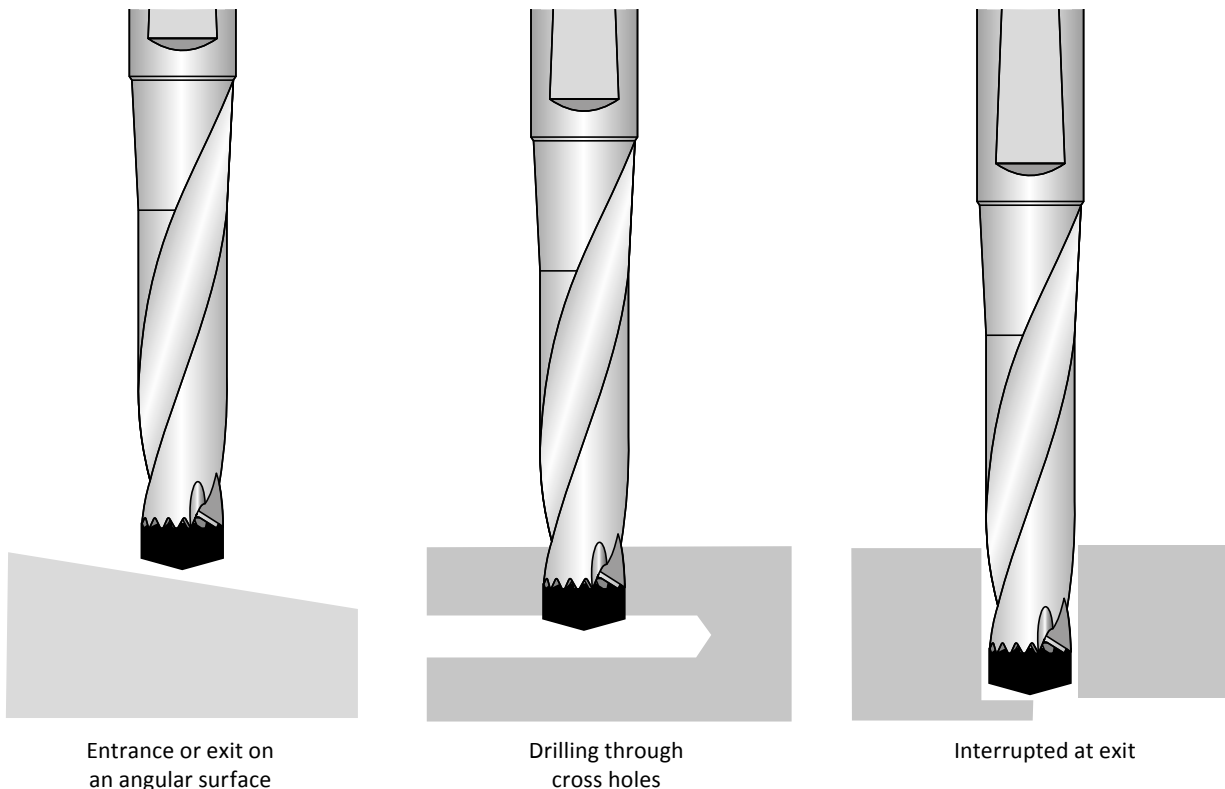





In these drilling scenarios, reducing feed rate to 1/3 (33%) is generally recommended. Drilling into an entry angle of more than 10° is NOT recommended – surface should be milled flat first.





INDEXABLE DRILLS – OVERVIEW

Working length	2×D	3×D	4×D	5×D	XPET..AP	SCET..UD	XPET..AP-SD	SCET..-SD
Picture								
Coolant					-	-	-	-
	516	518	521	523	515	514	515	514
Drill type	802D	803D	804D	805D	-	-	-	-
Drill tolerance	± 0.05	± 0.05	± 0.05	± 0.05	-	-	-	-
Hole tolerance *	0/+0.2	0/+0.3	0/+0.4	0/+0.5	-	-	-	-
Surface finish *	R _a 2–6 μm	R _a 2–6 μm	R _a 2–6 μm	R _a 2–6 μm	-	-	-	-
Diameter range	15.0–40.0	15.0–58.0	17.0–58.0	19.0–31.0	-	-	-	-
Application areas	P1				■	■	■	■
	P2				■	■	■	■
	P3				■	■	■	■
	P4				■	■	■	■
	M1						■	■
	M2						■	■
	M3						■	■
	M4						■	■
	K1				☑	■	☑	☑
	K2				☑	■	☑	☑
	K3				☑	■	☑	☑
	K4				☑	■	☑	☑
	K5				☑	■	☑	☑
S1						☑	☑	
S2						☑	☑	
S3						☑	☑	
S4						☑	☑	

* The tolerance of drilled hole and surface finish are heavily dependent on machining conditions.



CODE KEY FOR DRILLS

1	2	3		4		5		6	7
8	05	D	-	19	-	95	-	S	25

*Marking is valid for types produced from 2011



Indexable drill *

1		2		3		4	
Tool type		Approximate length		Variant		Cutting diameter	
8	Indexable drill	02	2 × DC	D	Drill	15.5	DC = 15.5 mm
		03	3 × DC				19
		04	4 × DC				
		05	5 × DC				
5		6		7			
Max. drilling depth		Type of shank		Shank diameter			
35	35 mm	E	Whistle Notch	25	DCON MS = 25 mm		
95	95 mm			32	DCON MS = 32 mm		
140	140 mm	S	ISO 9766	40	DCON MS = 40 mm		



SCET



	IC	D1	L	S
	(mm)	(mm)	(mm)	(mm)
0502	5.556	2.40	5.56	2.38
0602	6.350	2.90	6.35	2.38
0703	7.937	3.50	7.94	3.18
09T3	9.525	4.50	9.53	3.97
1204	12.700	5.60	12.70	4.76
1505	15.875	5.60	15.88	5.56

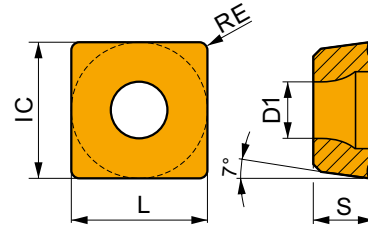

Suitability and starting values for cutting speed (vc), feed (f) and depth of cut (ap). Refer to our Machining Calculator app for further calculations.

Product	RE	P			M			K			N			S			H		
		vc	f	ap	vc	f	ap	vc	f	ap	vc	f	ap	vc	f	ap	vc	f	ap
	(mm)	(m/min)	(mm/rev)	(mm)	(m/min)	(mm/rev)	(mm)	(m/min)	(mm/rev)	(mm)	(m/min)	(mm/rev)	(mm)	(m/min)	(mm/rev)	(mm)	(m/min)	(mm/rev)	(mm)

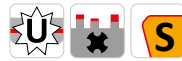
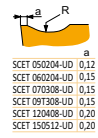

UD geometry with universal design for periphery inserts.

SCET 050204-UD	D8330	0.4	█	165	0.08	–	–	–	–	█	155	0.08	–	–	–	–	–	–	–	–
	D9335	0.4	█	240	0.08	–	–	–	–	█	225	0.08	–	–	–	–	–	–	–	–
SCET 060204-UD	D8330	0.4	█	165	0.11	–	–	–	–	█	155	0.11	–	–	–	–	–	–	–	–
	D9335	0.4	█	240	0.11	–	–	–	–	█	225	0.11	–	–	–	–	–	–	–	–
SCET 070308-UD	D8330	0.8	█	165	0.13	–	–	–	–	█	155	0.13	–	–	–	–	–	–	–	–
	D9335	0.8	█	240	0.13	–	–	–	–	█	225	0.13	–	–	–	–	–	–	–	–
SCET 09T308-UD	D8330	0.8	█	165	0.14	–	–	–	–	█	155	0.14	–	–	–	–	–	–	–	–
	D9335	0.8	█	240	0.14	–	–	–	–	█	225	0.14	–	–	–	–	–	–	–	–
SCET 120408-UD	D8330	0.8	█	165	0.16	–	–	–	–	█	155	0.16	–	–	–	–	–	–	–	–
	D9335	0.8	█	240	0.16	–	–	–	–	█	225	0.16	–	–	–	–	–	–	–	–
SCET 150512-UD	D8330	1.2	█	165	0.18	–	–	–	–	█	155	0.18	–	–	–	–	–	–	–	–
	D9335	1.2	█	240	0.18	–	–	–	–	█	225	0.18	–	–	–	–	–	–	–	–

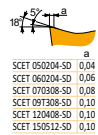

SD geometry with positive design for periphery inserts.

SCET 050204-SD	D8330	0.4	█	165	0.08	–	█	95	0.07	–	█	155	0.08	–	–	–	█	40	0.06	–	–	–
	D9335	0.4	█	240	0.08	–	█	140	0.07	–	█	225	0.08	–	–	–	█	60	0.06	–	–	–
SCET 060204-SD	D8330	0.4	█	165	0.11	–	█	95	0.09	–	█	155	0.11	–	–	–	█	40	0.07	–	–	–
	D9335	0.4	█	240	0.11	–	█	140	0.09	–	█	225	0.11	–	–	–	█	60	0.07	–	–	–
SCET 070308-SD	D8330	0.8	█	165	0.13	–	█	95	0.11	–	█	155	0.13	–	–	–	█	40	0.09	–	–	–
	D9335	0.8	█	240	0.13	–	█	140	0.11	–	█	225	0.13	–	–	–	█	60	0.09	–	–	–
SCET 09T308-SD	D8330	0.8	█	165	0.14	–	█	95	0.13	–	█	155	0.14	–	–	–	█	40	0.10	–	–	–
	D9335	0.8	█	240	0.14	–	█	140	0.13	–	█	225	0.14	–	–	–	█	60	0.10	–	–	–
SCET 120408-SD	D8330	0.8	█	165	0.16	–	█	95	0.14	–	█	155	0.16	–	–	–	█	40	0.11	–	–	–
	D9335	0.8	█	240	0.16	–	█	140	0.14	–	█	225	0.16	–	–	–	█	60	0.11	–	–	–
SCET 150512-SD	D8330	1.2	█	165	0.18	–	█	95	0.16	–	█	155	0.18	–	–	–	█	40	0.12	–	–	–
	D9335	1.2	█	240	0.18	–	█	140	0.16	–	█	225	0.18	–	–	–	█	60	0.12	–	–	–



XPET



	IC (mm)	D1 (mm)	L (mm)	S (mm)
0502	5.556	2.40	5.56	2.38
0602	6.350	2.60	6.35	2.38
0703	7.937	2.90	7.94	3.18
0903	9.525	3.50	9.53	3.18
11T3	11.509	3.90	11.50	3.97
12T3	12.700	3.90	12.70	3.97
1504	15.875	4.50	15.88	4.76
1904	19.050	4.50	19.05	4.76

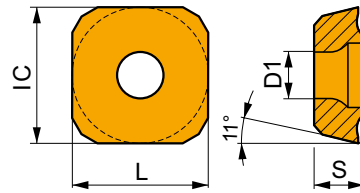

Suitability and starting values for cutting speed (vc), feed (f) and depth of cut (ap). Refer to our Machining Calculator app for further calculations.

Product	RE (mm)	P			M			K			N			S			H		
		vc (m/min)	f (mm/rev)	ap (mm)	vc (m/min)	f (mm/rev)	ap (mm)	vc (m/min)	f (mm/rev)	ap (mm)	vc (m/min)	f (mm/rev)	ap (mm)	vc (m/min)	f (mm/rev)	ap (mm)			



XPET 0502AP	0,10
XPET 0602AP	0,10
XPET 0703AP	0,15
XPET 0903AP	0,25
XPET 11T3AP	0,25
XPET 12T3AP	0,25
XPET 1504AP	0,25
XPET 1904AP	0,25



Geometry with universal design for central inserts.

XPET 0502AP	D8345	-	█	165	0.08	-	█	-	-	-	█	155	0.08	-	█	-	-	-	█	-	-	-
XPET 0602AP	D8345	-	█	165	0.11	-	█	-	-	-	█	155	0.11	-	█	-	-	-	█	-	-	-
XPET 0703AP	D8345	-	█	165	0.13	-	█	-	-	-	█	155	0.13	-	█	-	-	-	█	-	-	-
XPET 0903AP	D8345	-	█	165	0.14	-	█	-	-	-	█	155	0.14	-	█	-	-	-	█	-	-	-
XPET 11T3AP	D8345	-	█	165	0.16	-	█	-	-	-	█	155	0.16	-	█	-	-	-	█	-	-	-
XPET 12T3AP	D8345	-	█	165	0.16	-	█	-	-	-	█	155	0.16	-	█	-	-	-	█	-	-	-
XPET 1504AP	D8345	-	█	165	0.18	-	█	-	-	-	█	155	0.18	-	█	-	-	-	█	-	-	-
XPET 1904AP	D8345	-	█	165	0.18	-	█	-	-	-	█	155	0.18	-	█	-	-	-	█	-	-	-



XPET 0502AP-SD	0,04
XPET 0602AP-SD	0,05
XPET 0703AP-SD	0,08
XPET 0903AP-SD	0,10
XPET 11T3AP-SD	0,10
XPET 12T3AP-SD	0,10
XPET 1504AP-SD	0,10
XPET 1904AP-SD	0,12



SD geometry with positive design for central inserts.

XPET 0502AP-SD	D8345	-	█	165	0.08	-	█	95	0.07	-	█	155	0.08	-	█	40	0.06	-	█	-	-	-
XPET 0602AP-SD	D8345	-	█	165	0.11	-	█	95	0.09	-	█	155	0.11	-	█	40	0.07	-	█	-	-	-
XPET 0703AP-SD	D8345	-	█	165	0.13	-	█	95	0.11	-	█	155	0.13	-	█	40	0.09	-	█	-	-	-
XPET 0903AP-SD	D8345	-	█	165	0.14	-	█	95	0.13	-	█	155	0.14	-	█	40	0.10	-	█	-	-	-
XPET 11T3AP-SD	D8345	-	█	165	0.16	-	█	95	0.14	-	█	155	0.16	-	█	40	0.11	-	█	-	-	-
XPET 12T3AP-SD	D8345	-	█	165	0.16	-	█	95	0.14	-	█	155	0.16	-	█	40	0.11	-	█	-	-	-
XPET 1504AP-SD	D8345	-	█	165	0.18	-	█	95	0.16	-	█	155	0.18	-	█	40	0.12	-	█	-	-	-
XPET 1904AP-SD	D8345	-	█	165	0.18	-	█	95	0.16	-	█	155	0.18	-	█	40	0.12	-	█	-	-	-



802D



PRAMET

S



2xD 802D Indexable Insert Drill body with Internal Coolant Feed

High performance indexable insert drill body for drilling blind and through holes. Also, potentially cross hole, off center and stack drilling, helical interpolation, plunging, drilling on concave or angled surfaces, drilling with interrupted cuts, chamfer drilling and boring. Available from Ø15 up to Ø40 mm in 2xD.

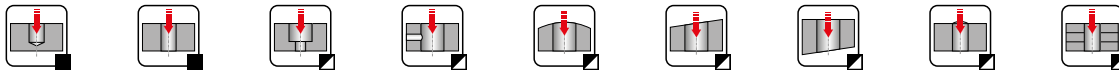
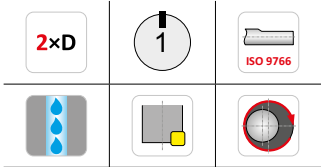
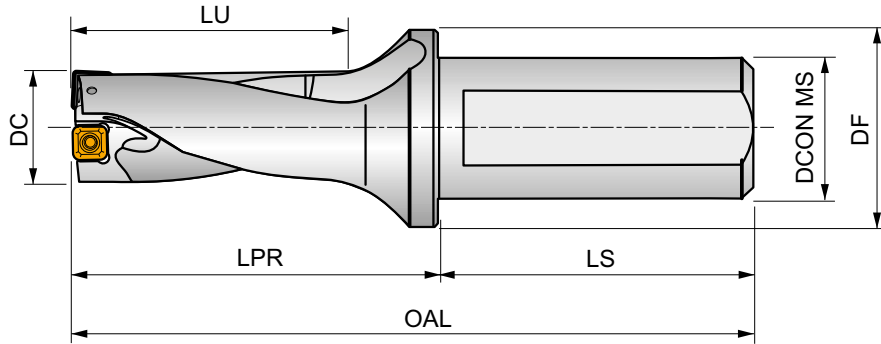

Product	DC	APMX	OAL	LPR	LS	LU	DCON MS	DF	$\overset{-}{D}$	$\overset{+}{D}$	G1300	G1313	G1317	G1320	G1321	G1322	kg	HM001
	(mm)	(mm)	(mm)	(mm)	(mm)	(mm)		(mm)	(mm)	(mm)								
802D-15-30-S25	15	30.00	121	65	56	34.5	25	35	0.25	0.35	EP253253	GI300	GI313	0.30	HM001			
802D-16-32-S25	16	32.00	123	67	56	37	25	35	0.15	0.45	EP253253	GI300	GI313	0.30	HM001			
802D-17-34-S25	17	34.00	125	69	56	39.5	25	35	0.10	0.50	EP253253	GI300	GI313	0.31	HM001			
802D-18-36-S25	18	36.00	127	71	56	42	25	35	0.35	0.25	EP253253	GI301	GI314	0.31	HM002			
802D-19-38-S25	19	38.00	129	73	56	44.5	25	35	0.15	0.45	EP253253	GI301	GI314	0.32	HM002			
802D-20-40-S25	20	40.00	131	75	56	47	25	35	0.10	0.45	EP253253	GI302	GI315	0.33	HM003			
802D-21-42-S25	21	42.00	133	77	56	49.5	25	35	0.10	0.50	EP253253	GI302	GI315	0.34	HM003			
802D-22-44-S25	22	44.00	135	79	56	52	25	35	0.45	0.50	EP253253	GI303	GI316	0.35	HM004			
802D-23-46-S25	23	46.00	137	81	56	54.5	25	35	0.35	0.50	EP253253	GI304	GI317	0.36	HM005			
802D-24-48-S25	24	48.00	139	83	56	57	25	35	0.15	0.50	EP253253	GI304	GI317	0.37	HM005			
802D-25-50-S32	25	50.00	145	85	60	57	32	42	0.15	0.50	EP324058	GI304	GI317	0.57	HM005			
802D-26-52-S32	26	52.00	147	87	60	59.5	32	42	0.10	0.50	EP324058	GI304	GI317	0.58	HM005			
802D-27-54-S32	27	54.00	149	89	60	62	32	42	0.50	0.30	EP324058	GI305	GI318	0.59	HM006			
802D-28-56-S32	28	56.00	151	91	60	64.5	32	42	0.30	0.50	EP324058	GI306	GI319	0.61	HM007			
802D-29-58-S32	29	58.00	153	93	60	67	32	42	0.20	0.50	EP324058	GI306	GI319	0.62	HM007			
802D-30-60-S32	30	60.00	155	95	60	69.5	32	42	0.15	0.50	EP324058	GI306	GI319	0.67	HM007			
802D-32-64-S32	32	64.00	159	99	60	70	32	42	0.50	0.35	EP324058	GI307	GI320	0.68	HM008			
802D-32-64-S40	32	64.00	167	99	68	70	40	50	0.50	0.35	-	GI307	GI320	1.03	HM008			
802D-34-68-S32	34	68.00	163	103	60	75	32	42	0.25	0.50	EP324058	GI307	GI320	0.73	HM008			
802D-34-68-S40	34	68.00	171	103	68	75	40	50	0.25	0.50	-	GI307	GI320	1.07	HM008			
802D-36-72-S32	36	72.00	167	107	60	80	32	42	0.10	0.50	EP324058	GI308	GI321	0.76	HM009			
802D-36-72-S40	36	72.00	173	105	68	77.5	40	50	0.10	0.50	-	GI308	GI321	1.11	HM009			
802D-38-76-S32	38	76.00	171	111	60	85	32	42	0.50	0.50	EP324058	GI308	GI321	0.83	HM009			
802D-38-76-S40	38	76.00	179	111	68	85	40	50	0.50	0.50	-	GI308	GI321	1.17	HM009			
802D-40-80-S32	40	80.00	175	115	60	90	32	42	0.20	0.50	EP324058	GI309	GI322	0.91	HM009			
802D-40-80-S40	40	80.00	183	115	68	90	40	50	0.20	0.50	-	GI309	GI322	1.25	HM009			



GI300	XPET 0502AP	SCET 050204-UD
GI301	XPET 0602AP	SCET 050204-UD
GI302	XPET 0602AP	SCET 060204-UD
GI303	XPET 0703AP	SCET 060204-UD
GI304	XPET 0703AP	SCET 070308-UD
GI305	XPET 0903AP	SCET 070308-UD
GI306	XPET 0903AP	SCET 09T308-UD
GI307	XPET 11T3AP	SCET 09T308-UD
GI308	XPET 11T3AP	SCET 120408-UD
GI309	XPET 12T3AP	SCET 120408-UD
GI313	XPET 0502AP-SD	SCET 050204-SD
GI314	XPET 0602AP-SD	SCET 050204-SD
GI315	XPET 0602AP-SD	SCET 060204-SD
GI316	XPET 0703AP-SD	SCET 060204-SD
GI317	XPET 0703AP-SD	SCET 070308-SD
GI318	XPET 0903AP-SD	SCET 070308-SD
GI319	XPET 0903AP-SD	SCET 09T308-SD
GI320	XPET 11T3AP-SD	SCET 09T308-SD
GI321	XPET 11T3AP-SD	SCET 120408-SD
GI322	XPET 12T3AP-SD	SCET 120408-SD

HM001	US 2245-T07P	0.9	US 2245-T07P	0.9	FLAG T07P
HM002	US 2205-T07P	0.9	US 2245-T07P	0.9	FLAG T07P
HM003	US 2205-T07P	0.9	US 2205-T07P	0.9	FLAG T07P
HM004	US 2506-T07P	1.2	US 2506-T07P	1.2	FLAG T07P
HM005	US 2507-T08P	1.2	US 3007-T08P	2.0	FLAG T08P
HM006	US 3007-T09P	2.0	US 3007-T09P	2.0	FLAG T09P
HM007	US 3007-T09P	2.0	US 3009-T09P	2.0	FLAG T09P
HM008	US 3510-T15P	3.0	US 3508-T15P	3.0	FLAG T15P
HM009	US 3510-T15P	3.0	US 5012-T15P	5.0	FLAG T15P



803D

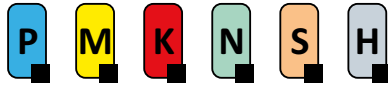

PRAMET

S



3xD 803D Indexable Insert Drill body with Internal Coolant Feed

High performance indexable insert drill body for drilling blind and through holes. Also, potentially cross hole, off center and stack drilling, helical interpolation, plunging, drilling on concave or angled surfaces, drilling with interrupted cuts, chamfer drilling and boring. Available from Ø15 up to Ø58 mm in 3xD.

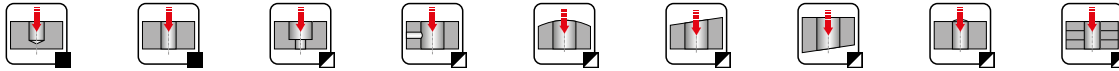
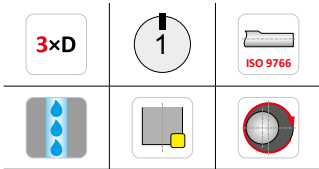
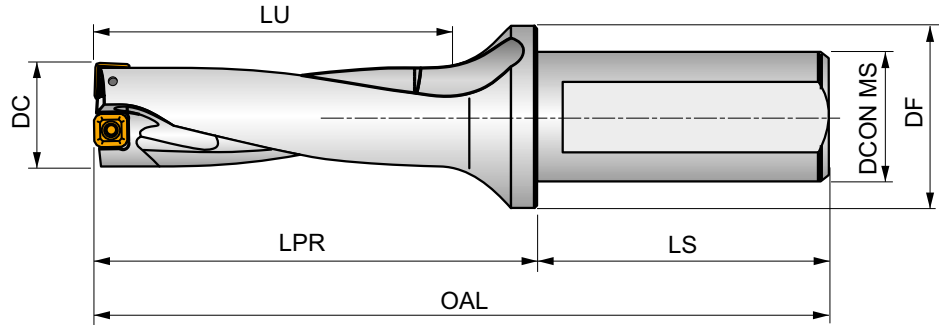

Product	DC	APMX	OAL	LPR	LS	LU	DCON MS	DF	$\overset{-}{D}$	$\overset{+}{D}$	G	G	G	kg	HM
	(mm)	(mm)	(mm)	(mm)	(mm)	(mm)		(mm)	(mm)	(mm)					
803D-15-45-S25	15	45.00	136	80	56	49.5	25	35	0.25	0.35	EP253253	GI300	GI313	0.31	HM001
803D-15,5-46,5-S25	15.5	47.00	137.5	81.5	56	51.2	25	35	0.30	0.35	EP253253	GI300	GI313	0.31	HM001
803D-16-48-S25	16	48.00	139	83	56	53	25	35	0.15	0.45	EP253253	GI300	GI313	0.32	HM001
803D-16,5-49,5-S25	16.5	50.00	140.5	84.5	56	54.7	25	35	0.15	0.40	EP253253	GI300	GI313	0.32	HM001
803D-17-51-S25	17	51.00	142	86	56	56.5	25	35	0.10	0.50	EP253253	GI300	GI313	0.32	HM001
803D-17,5-52,5-S25	17.5	53.00	143.5	87.5	56	58.2	25	35	0.50	0.50	EP253253	GI301	GI314	0.32	HM002
803D-18-54-S25	18	54.00	145	89	56	60	25	35	0.35	0.25	EP253253	GI301	GI314	0.33	HM002
803D-18,5-55,5-S25	18.5	56.00	146.5	90.5	56	61.2	25	35	0.35	0.25	EP253253	GI301	GI314	0.34	HM002
803D-19-57-S25	19	57.00	148	92	56	63.5	25	35	0.15	0.45	EP253253	GI301	GI314	0.34	HM002
803D-19,5-58,5-S25	19.5	59.00	149.5	93.5	56	63.7	25	35	0.25	0.40	EP253253	GI302	GI315	0.34	HM003
803D-20-60-S25	20	60.00	151	95	56	67	25	35	0.10	0.45	EP253253	GI302	GI315	0.35	HM003
803D-20,5-61,5-S25	20.5	62.00	152.5	96.5	56	67.2	25	35	0.10	0.50	EP253253	GI302	GI315	0.36	HM003
803D-21-63-S25	21	63.00	154	98	56	70.5	25	35	0.10	0.50	EP253253	GI302	GI315	0.36	HM003
803D-21,5-64,5-S25	21.5	65.00	155.5	99.5	56	70.8	25	35	0.35	0.50	EP253253	GI303	GI316	0.37	HM004
803D-22-66-S25	22	66.00	157	101	56	74	25	35	0.45	0.50	EP253253	GI303	GI316	0.38	HM004
803D-22,5-67,5-S25	22.5	68.00	158.5	102.5	56	74.3	25	35	0.35	0.50	EP253253	GI304	GI317	0.39	HM005
803D-23-69-S25	23	69.00	160	104	56	77.5	25	35	0.35	0.50	EP253253	GI304	GI317	0.40	HM005
803D-23,5-70,5-S25	23.5	71.00	161.5	105.5	56	77.6	25	35	0.10	0.50	EP253253	GI304	GI317	0.40	HM005
803D-24-72-S25	24	72.00	163	107	56	81	25	35	0.15	0.50	EP253253	GI304	GI317	0.41	HM005
803D-24,5-73,5-S25	24.5	74.00	168.5	108.5	60	78.7	25	35	0.10	0.50	EP253253	GI304	GI317	0.42	HM005
803D-25-75-S32	25	75.00	170	110	60	82	32	42	0.15	0.50	EP324058	GI304	GI317	0.62	HM005
803D-25,5-76,5-S32	25.5	77.00	171.5	111.5	60	82.2	32	42	0.50	0.10	EP324058	GI304	GI317	0.63	HM005
803D-26-78-S32	26	78.00	173	113	60	85.5	32	42	0.10	0.50	EP324058	GI304	GI317	0.64	HM005
803D-26,5-79,5-S32	26.5	80.00	174.5	114.5	60	85.7	32	42	0.50	0.10	EP324058	GI305	GI318	0.65	HM006
803D-27-81-S32	27	81.00	176	116	60	89	32	42	0.50	0.30	EP324058	GI305	GI318	0.65	HM006
803D-28-84-S32	28	84.00	179	119	60	92.5	32	42	0.30	0.50	EP324058	GI306	GI319	0.68	HM007
803D-29-87-S32	29	87.00	182	122	60	96	32	42	0.20	0.50	EP324058	GI306	GI319	0.70	HM007



Product	DC	APMX	OAL	LPR	LS	LU	DCONIMS	DF	\bar{D}	D^+					
	(mm)	(mm)	(mm)	(mm)	(mm)	(mm)	(mm)	(mm)	(mm)	(mm)					
803D-30-90-S32	30	90.00	185	125	60	99.5	32	42	0.15	0.50	EP324058	GI306	GI319	0.73	HM007
803D-31-93-S32	31	93.00	188	128	60	103	32	42	0.15	0.50	EP324058	GI306	GI319	0.76	HM007
803D-32-96-S32	32	96.00	191	131	60	102	32	42	0.50	0.30	EP324058	GI307	GI320	0.79	HM008
803D-32-96-S40	32	96.00	199	131	68	102	40	50	0.50	0.30	–	GI307	GI320	1.14	HM008
803D-33-99-S32	33	99.00	194	134	60	105.5	32	42	0.50	0.50	EP324058	GI307	GI320	0.83	HM008
803D-33-99-S40	33	99.00	202	134	68	105.5	40	50	0.50	0.50	–	GI307	GI320	1.18	HM008
803D-34-102-S32	34	102.00	197	137	60	109	32	42	0.25	0.50	EP324058	GI307	GI320	0.86	HM008
803D-34-102-S40	34	102.00	205	137	68	109	40	50	0.25	0.50	–	GI307	GI320	1.12	HM008
803D-35-105-S32	35	105.00	200	140	60	112.5	32	42	0.25	0.50	EP324058	GI308	GI321	0.90	HM009
803D-35-105-S40	35	105.00	208	140	68	112.5	40	50	0.25	0.50	–	GI308	GI321	1.24	HM009
803D-36-108-S32	36	108.00	203	143	60	116	32	42	0.10	0.50	EP324058	GI308	GI321	0.91	HM009
803D-36-108-S40	36	108.00	211	143	68	116	40	50	0.10	0.50	–	GI308	GI321	1.25	HM009
803D-37-111-S32	37	111.00	206	146	60	119.5	32	42	0.10	0.50	EP324058	GI308	GI321	0.95	HM009
803D-37-111-S40	37	111.00	214	146	68	119.5	40	50	0.10	0.50	–	GI308	GI321	1.29	HM009
803D-38-114-S32	38	114.00	199	139	60	124.5	32	42	0.50	0.50	EP324058	GI308	GI321	1.00	HM009
803D-38-114-S40	38	114.00	217	149	68	123	40	50	0.50	0.50	–	GI308	GI321	1.34	HM009
803D-39-117-S32	38	114.00	209	149	60	123	32	42	0.40	0.50	EP324058	GI309	GI322	1.06	HM009
803D-39-117-S40	39	117.00	220	152	68	126.5	40	50	0.40	0.50	–	GI309	GI322	1.40	HM009
803D-40-120-S32	40	120.00	215	155	60	130	32	42	0.20	0.50	EP324058	GI309	GI322	1.12	HM009
803D-40-120-S40	40	120.00	223	155	68	130	40	50	0.20	0.50	–	GI309	GI322	1.46	HM009
803D-41-123-S40	41	123.00	219	149	70	133	40	50	0.20	0.50	–	GI309	GI322	1.48	HM009
803D-42-126-S40	42	126.00	221.5	152	70	136	40	50	0.15	0.50	–	GI309	GI322	1.52	HM009
803D-43-129-S40	43	129.00	224	154	70	139	40	50	0.10	0.50	–	GI309	GI322	1.58	HM009
803D-44-132-S40	44	132.00	226.5	157	70	142	40	50	0.50	0.50	–	GI310	GI323	1.63	HM010
803D-45-135-S40	45	135.00	230.5	161	70	144	40	55	0.50	0.50	–	GI311	GI324	1.73	HM010
803D-46-138-S40	46	138.00	235	165	70	148	40	55	0.50	0.50	–	GI311	GI324	1.82	HM010
803D-47-141-S40	47	141.00	237.5	168	70	151	40	55	0.50	0.50	–	GI311	GI324	1.90	HM010
803D-48-144-S40	48	144.00	240	170	70	154	40	55	0.50	0.50	–	GI311	GI324	1.98	HM010
803D-49-147-S40	49	147.00	242.5	173	70	157	40	55	0.30	0.50	–	GI311	GI324	2.06	HM010
803D-50-150-S40	50	150.00	246.5	177	70	160	40	58	0.15	0.50	–	GI311	GI324	2.18	HM010
803D-51-153-S40	51	153.00	249	179	70	163	40	58	0.15	0.50	–	GI311	GI324	2.24	HM010
803D-52-156-S40	52	156.00	251.5	182	70	166	40	58	0.50	0.50	–	GI312	GI325	2.20	HM010
803D-53-159-S40	53	159.00	254	184	70	169	40	58	0.50	0.50	–	GI312	GI325	2.29	HM010
803D-54-162-S40	54	162.00	257.5	188	70	173	40	58	0.50	0.50	–	GI312	GI325	2.39	HM010
803D-55-165-S40	55	165.00	260	190	70	176	40	58	0.50	0.50	–	GI312	GI325	2.46	HM010
803D-56-168-S40	56	168.00	264	194	70	179	40	58	0.50	0.50	–	GI312	GI325	2.59	HM010
803D-57-171-S40	57	171.00	266.5	197	70	182	40	58	0.35	0.50	–	GI312	GI325	2.70	HM010
803D-58-174-S40	58	174.00	270	200	70	186	40	58	0.15	0.50	–	GI312	GI325	2.83	HM010



GI300	XPET 0502AP	SCET 050204-UD
GI301	XPET 0602AP	SCET 050204-UD
GI302	XPET 0602AP	SCET 060204-UD
GI303	XPET 0703AP	SCET 060204-UD
GI304	XPET 0703AP	SCET 070308-UD
GI305	XPET 0903AP	SCET 070308-UD
GI306	XPET 0903AP	SCET 09T308-UD
GI307	XPET 11T3AP	SCET 09T308-UD
GI308	XPET 11T3AP	SCET 120408-UD
GI309	XPET 12T3AP	SCET 120408-UD
GI310	XPET 1504AP	SCET 120408-UD
GI311	XPET 1504AP	SCET 150512-UD
GI312	XPET 1904AP	SCET 150512-UD
GI313	XPET 0502AP-SD	SCET 050204-SD
GI314	XPET 0602AP-SD	SCET 050204-SD
GI315	XPET 0602AP-SD	SCET 060204-SD
GI316	XPET 0703AP-SD	SCET 060204-SD
GI317	XPET 0703AP-SD	SCET 070308-SD
GI318	XPET 0903AP-SD	SCET 070308-SD
GI319	XPET 0903AP-SD	SCET 09T308-SD



GI320	XPET 11T3AP-SD	SCET 09T308-SD
GI321	XPET 11T3AP-SD	SCET 120408-SD
GI322	XPET 12T3AP-SD	SCET 120408-SD
GI323	XPET 1504AP-SD	SCET 120408-SD
GI324	XPET 1504AP-SD	SCET 150512-SD
GI325	XPET 1904AP-SD	SCET 150512-SD

HM001	US 2245-T07P	0.9	US 2245-T07P	0.9	FLAG T07P
HM002	US 2205-T07P	0.9	US 2245-T07P	0.9	FLAG T07P
HM003	US 2205-T07P	0.9	US 2205-T07P	0.9	FLAG T07P
HM004	US 2506-T07P	1.2	US 2506-T07P	1.2	FLAG T07P
HM005	US 2507-T08P	1.2	US 3007-T08P	2.0	FLAG T08P
HM006	US 3007-T09P	2.0	US 3007-T09P	2.0	FLAG T09P
HM007	US 3007-T09P	2.0	US 3009-T09P	2.0	FLAG T09P
HM008	US 3510-T15P	3.0	US 3508-T15P	3.0	FLAG T15P
HM009	US 3510-T15P	3.0	US 5012-T15P	5.0	FLAG T15P
HM010	US 4011-T15P	3.5	US 5012-T15P	5.0	FLAG T15P



804D

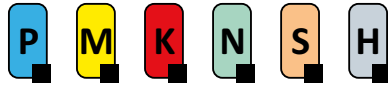

PRAMET

S



4xD 804D Indexable Insert Drill body with Internal Coolant Feed

High performance indexable insert drill body for drilling blind and through holes. Also, potentially cross hole, off center and stack drilling, helical interpolation, plunging, drilling on concave or angled surfaces, drilling with interrupted cuts, chamfer drilling and boring. Available from Ø17 up to Ø58 mm in 4xD.

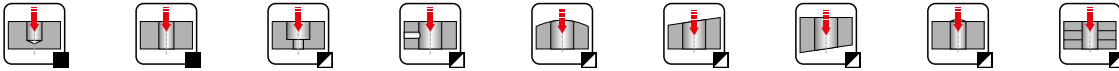
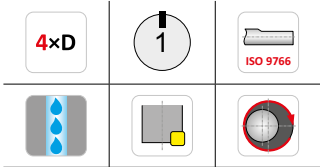
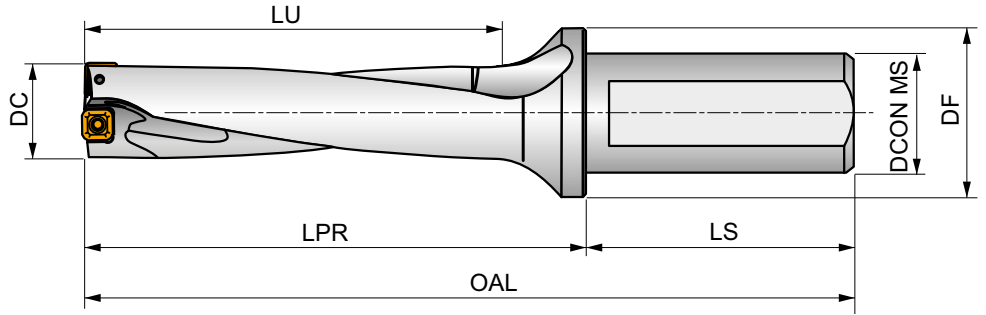

Product	DC	APMX	OAL	LPR	LS	LU	DCON MS	DF	$\overset{\uparrow}{D}$	$\overset{\downarrow}{D}^+$						
	(mm)	(mm)	(mm)	(mm)	(mm)	(mm)	(mm)	(mm)	(mm)	(mm)						
804D-17-68-S25	17	68.00	149	93	56	73	25	35	0.10	0.50	–	GI300	GI313	0.34	HM001	
804D-18-72-S25	18	72.00	153	97	56	77	25	35	0.35	0.25	–	GI301	GI314	0.35	HM002	
804D-19-76-S25	19	76.00	157	101	56	81.5	25	35	0.15	0.45	–	GI301	GI314	0.36	HM002	
804D-20-80-S25	20	80.00	161	105	56	85	25	35	0.10	0.45	–	GI302	GI315	0.37	HM003	
804D-21-84-S25	21	84.00	165	109	56	89.5	25	35	0.10	0.50	–	GI302	GI315	0.39	HM003	
804D-22-88-S25	22	88.00	169	113	56	94	25	35	0.45	0.50	–	GI303	GI316	0.41	HM004	
804D-23-92-S25	23	92.00	173	117	56	98.5	25	35	0.35	0.50	–	GI304	GI317	0.44	HM005	
804D-24-96-S25	24	96.00	177	121	56	103	25	35	0.15	0.50	–	GI304	GI317	0.45	HM005	
804D-25-100-S32	25	100.00	185	125	60	105	32	42	0.15	0.50	–	GI304	GI317	0.67	HM005	
804D-26-104-S32	26	104.00	189	129	60	109.5	32	42	0.10	0.50	–	GI304	GI317	0.70	HM005	
804D-27-108-S32	27	108.00	193	133	60	114	32	42	0.50	0.30	–	GI305	GI318	0.71	HM006	
804D-28-112-S32	28	112.00	197	137	60	118.5	32	42	0.30	0.50	–	GI306	GI319	0.75	HM007	
804D-29-116-S32	29	116.00	201	141	60	123	32	42	0.20	0.50	–	GI306	GI319	0.78	HM007	
804D-30-120-S32	30	120.00	205	145	60	127.5	32	42	0.15	0.50	–	GI306	GI319	0.82	HM007	
804D-31-124-S32	31	124.00	209	149	60	132	32	42	0.15	0.50	–	GI306	GI319	0.85	HM007	
804D-32-128-S32	32	128.00	213	153	60	136.5	32	42	0.50	0.30	–	GI307	GI320	0.90	HM008	
804D-33-132-S32	33	132.00	217	157	60	141	32	42	0.50	0.50	–	GI307	GI320	0.95	HM008	
804D-34-136-S32	34	136.00	221	161	60	145.5	32	42	0.25	0.50	–	GI307	GI320	0.99	HM008	
804D-35-140-S32	35	140.00	225	165	60	149	32	42	0.25	0.50	–	GI308	GI321	1.04	HM009	
804D-36-144-S32	36	144.00	229	169	60	153.5	32	42	0.10	0.50	–	GI308	GI321	1.05	HM009	
804D-37-148-S32	37	148.00	233	173	60	158	32	42	0.10	0.50	–	GI308	GI321	1.11	HM009	
804D-38-152-S32	38	152.00	237	177	60	162.5	32	42	0.50	0.50	–	GI308	GI321	1.18	HM009	
804D-39-156-S32	39	156.00	241	181	60	167	32	42	0.40	0.50	–	GI309	GI322	1.25	HM009	
804D-40-160-S32	40	160.00	245	185	60	171.5	32	42	0.20	0.50	–	GI309	GI322	1.33	HM009	
804D-41-164-S40	41	164.00	259	189	70	172	40	50	0.20	0.50	–	GI309	GI322	1.68	HM009	
804D-42-168-S40	42	168.00	263	193	70	176.5	40	50	0.15	0.50	–	GI309	GI322	1.76	HM009	
804D-43-172-S40	43	172.00	267	197	70	181	40	50	0.10	0.50	–	GI309	GI322	1.83	HM009	



Product	DC	APMX	OAL	LPR	LS	LU	DCONIMS	DF	\bar{D}	D^+					
	(mm)	(mm)	(mm)	(mm)	(mm)	(mm)		(mm)	(mm)	(mm)					
804D-44-176-540	44	176.00	271	201	70	185.5	40	50	0.50	0.50	–	GI310	GI323	1.91	HM010
804D-45-180-540	45	180.00	275	205	70	187.5	40	55	0.50	0.50	–	GI311	GI324	2.02	HM010
804D-46-184-540	46	184.00	279	209	70	192	40	55	0.50	0.50	–	GI311	GI324	2.12	HM010
804D-47-188-540	47	188.00	283	213	70	196.5	40	55	0.50	0.50	–	GI311	GI324	2.22	HM010
804D-48-192-540	48	192.00	287	217	70	201	40	55	0.50	0.50	–	GI311	GI324	2.33	HM010
804D-49-196-540	49	196.00	291	221	70	205.5	40	55	0.30	0.50	–	GI311	GI324	2.45	HM010
804D-50-200-540	50	200.00	295	225	70	208.5	40	58	0.15	0.50	–	GI311	GI324	2.58	HM010
804D-51-204-540	51	204.00	299	229	70	213	40	58	0.15	0.50	–	GI311	GI324	2.68	HM010
804D-52-208-540	52	208.00	303	233	70	217.5	40	58	0.50	0.50	–	GI312	GI325	2.64	HM010
804D-53-212-540	53	212.00	307	237	70	222	40	58	0.50	0.50	–	GI312	GI325	2.76	HM010
804D-54-216-540	54	216.00	311	241	70	226.5	40	58	0.50	0.50	–	GI312	GI325	2.90	HM010
804D-55-220-540	55	220.00	315	245	70	231	40	58	0.50	0.50	–	GI312	GI325	3.00	HM010
804D-56-224-540	56	224.00	319	249	70	235.5	40	58	0.50	0.50	–	GI312	GI325	3.15	HM010
804D-57-228-540	57	228.00	323	253	70	240	40	58	0.35	0.50	–	GI312	GI325	3.30	HM010
804D-58-232-540	58	232.00	327	257	70	244.5	40	58	0.15	0.50	–	GI312	GI325	3.46	HM010

GI300	XPET 0502AP	SCET 050204-UD
GI301	XPET 0602AP	SCET 050204-UD
GI302	XPET 0602AP	SCET 060204-UD
GI303	XPET 0703AP	SCET 060204-UD
GI304	XPET 0703AP	SCET 070308-UD
GI305	XPET 0903AP	SCET 070308-UD
GI306	XPET 0903AP	SCET 09T308-UD
GI307	XPET 11T3AP	SCET 09T308-UD
GI308	XPET 11T3AP	SCET 120408-UD
GI309	XPET 12T3AP	SCET 120408-UD
GI310	XPET 1504AP	SCET 120408-UD
GI311	XPET 1504AP	SCET 150512-UD
GI312	XPET 1904AP	SCET 150512-UD
GI313	XPET 0502AP-SD	SCET 050204-SD
GI314	XPET 0602AP-SD	SCET 050204-SD
GI315	XPET 0602AP-SD	SCET 060204-SD
GI316	XPET 0703AP-SD	SCET 060204-SD
GI317	XPET 0703AP-SD	SCET 070308-SD
GI318	XPET 0903AP-SD	SCET 070308-SD
GI319	XPET 0903AP-SD	SCET 09T308-SD
GI320	XPET 11T3AP-SD	SCET 09T308-SD
GI321	XPET 11T3AP-SD	SCET 120408-SD
GI322	XPET 12T3AP-SD	SCET 120408-SD
GI323	XPET 1504AP-SD	SCET 120408-SD
GI324	XPET 1504AP-SD	SCET 150512-SD
GI325	XPET 1904AP-SD	SCET 150512-SD

HM001	US 2245-T07P	0.9	US 2245-T07P	0.9	FLAG T07P
HM002	US 2205-T07P	0.9	US 2245-T07P	0.9	FLAG T07P
HM003	US 2205-T07P	0.9	US 2205-T07P	0.9	FLAG T07P
HM004	US 2506-T07P	1.2	US 2506-T07P	1.2	FLAG T07P
HM005	US 2507-T08P	1.2	US 3007-T08P	2.0	FLAG T08P
HM006	US 3007-T09P	2.0	US 3007-T09P	2.0	FLAG T09P
HM007	US 3007-T09P	2.0	US 3009-T09P	2.0	FLAG T09P
HM008	US 3510-T15P	3.0	US 3508-T15P	3.0	FLAG T15P
HM009	US 3510-T15P	3.0	US 5012-T15P	5.0	FLAG T15P
HM010	US 4011-T15P	3.5	US 5012-T15P	5.0	FLAG T15P



805D

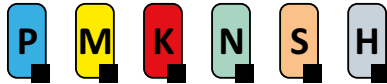

PRAMET

S



5xD 805D Indexable Insert Drill body with Internal Coolant Feed

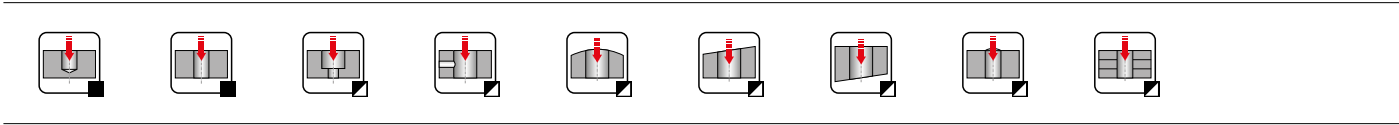
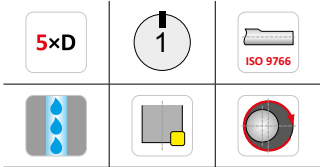
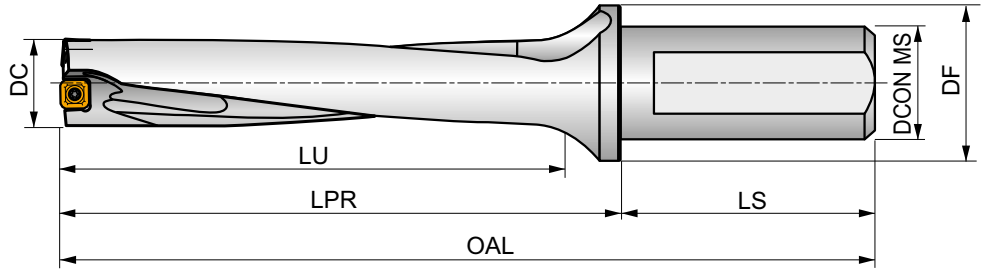

High performance indexable insert drill body for drilling blind and through holes. Also, potentially cross hole, off center and stack drilling, helical interpolation, plunging, drilling on concave or angled surfaces, drilling with interrupted cuts, chamfer drilling and boring. Available from Ø19 up to Ø31 mm in 5xD.









Product	DC	APMX	OAL	LPR	LS	LU	DCON MS	DF	\bar{D}	\bar{D}^+					
	(mm)	(mm)	(mm)	(mm)	(mm)	(mm)	(mm)	(mm)	(mm)	(mm)			kg		
805D-19-95-S25	19	95.00	176	120	56	100.5	25	35	0.15	0.45	–	GI301	GI314	0.38	HM002
805D-20-100-S25	20	100.00	181	125	56	105	25	35	0.10	0.45	–	GI302	GI315	0.40	HM003
805D-21-105-S25	21	105.00	186	130	56	110.5	25	35	0.10	0.50	–	GI302	GI315	0.42	HM003
805D-22-110-S25	22	110.00	191	135	56	116	25	35	0.45	0.50	–	GI303	GI316	0.45	HM004
805D-23-115-S25	23	115.00	196	140	56	121.5	25	35	0.35	0.50	–	GI304	GI317	0.48	HM005
805D-24-120-S25	24	120.00	201	145	56	127	25	35	0.15	0.50	–	GI304	GI317	0.49	HM005
805D-25-125-S32	25	125.00	210	150	60	130	32	42	0.15	0.50	–	GI304	GI317	0.72	HM005
805D-26-130-S32	26	130.00	215	155	60	135.5	32	42	0.10	0.50	–	GI304	GI317	0.75	HM005
805D-27-135-S32	27	135.00	220	160	60	141	32	42	0.50	0.30	–	GI305	GI318	0.78	HM006
805D-28-140-S32	28	140.00	225	165	60	146.5	32	42	0.30	0.50	–	GI306	GI319	0.82	HM007
805D-29-145-S32	29	145.00	230	170	60	152	32	42	0.20	0.50	–	GI306	GI319	0.86	HM007
805D-30-150-S32	30	150.00	235	175	60	157.5	32	42	0.15	0.50	–	GI306	GI319	0.90	HM007
805D-31-155-S32	31	155.00	240	180	60	163	32	42	0.15	0.50	–	GI306	GI319	0.95	HM007

GI301	XPET 0602AP	SCET 050204-UD
GI302	XPET 0602AP	SCET 060204-UD
GI303	XPET 0703AP	SCET 060204-UD
GI304	XPET 0703AP	SCET 070308-UD
GI305	XPET 0903AP	SCET 070308-UD
GI306	XPET 0903AP	SCET 09T308-UD
GI314	XPET 0602AP-SD	SCET 050204-SD
GI315	XPET 0602AP-SD	SCET 060204-SD
GI316	XPET 0703AP-SD	SCET 060204-SD
GI317	XPET 0703AP-SD	SCET 070308-SD
GI318	XPET 0903AP-SD	SCET 070308-SD



		
GI319	XPET 0903AP-SD	SCET 09T308-SD

		 Nm		 Nm	
HM002	US 2205-T07P	0.9	US 2245-T07P	0.9	FLAG T07P
HM003	US 2205-T07P	0.9	US 2205-T07P	0.9	FLAG T07P
HM004	US 2506-T07P	1.2	US 2506-T07P	1.2	FLAG T07P
HM005	US 2507-T08P	1.2	US 3007-T08P	2.0	FLAG T08P
HM006	US 3007-T09P	2.0	US 3007-T09P	2.0	FLAG T09P
HM007	US 3007-T09P	2.0	US 3009-T09P	2.0	FLAG T09P



INDEXABLE DRILLS – RECOMMENDED CUTTING CONDITIONS

802D, 803D (XPET..AP, SCET..-UD)



	D9335	D8330	D8345	∅ 15	∅ 20	∅ 25	∅ 30	∅ 40	∅ 58
P1	■	■	■	0.07	0.08	0.09	0.10	0.12	0.16
P2	■	■	■	0.11	0.13	0.15	0.17	0.21	0.28
P3	■	■	■	0.13	0.15	0.18	0.20	0.24	0.32
P4	■	■	■	0.12	0.14	0.16	0.18	0.22	0.30
K1	■	■	■	0.14	0.16	0.19	0.21	0.26	0.34
K2	■	■	■	0.14	0.16	0.19	0.21	0.26	0.34
K3	■	■	■	0.14	0.16	0.19	0.21	0.26	0.34
K4	■	■	■	0.14	0.16	0.19	0.21	0.26	0.34
K5	■	■	■	0.14	0.16	0.19	0.21	0.26	0.34

802D, 803D (XPET..AP-SD, SCET..-SD)



	D9335	D8330	D8345	∅ 15	∅ 20	∅ 25	∅ 30	∅ 40	∅ 58
P1	■	■	■	0.08	0.09	0.10	0.11	0.14	0.18
P2	■	■	■	0.11	0.13	0.15	0.17	0.21	0.28
P3	■	■	■	0.13	0.15	0.18	0.20	0.24	0.32
P4	■	■	■	–	–	–	–	–	–
K1	☑	☑	☑	0.08	0.09	0.10	0.11	0.14	0.18
K2	☑	☑	☑	0.11	0.13	0.15	0.17	0.21	0.28
K3	☑	☑	☑	0.12	0.14	0.16	0.18	0.22	0.24
K4	☑	☑	☑	0.13	0.15	0.18	0.20	0.24	0.32
K5	☑	☑	☑	0.14	0.16	0.19	0.21	0.25	0.33
M1	■	■	■	0.12	0.14	0.16	0.18	0.22	0.30
M2	■	■	■	0.11	0.13	0.15	0.17	0.21	0.28
M3	■	■	■	0.07	0.08	0.09	0.10	0.12	0.16
M4	■	■	■	0.07	0.08	0.09	0.10	0.12	0.16
S1	☑	☑	☑	0.08	0.09	0.10	0.11	0.14	0.18
S2	☑	☑	☑	0.08	0.09	0.10	0.11	0.14	0.18
S3	☑	☑	☑	0.07	0.08	0.09	0.10	0.12	0.16
S4	☑	☑	☑	0.07	0.08	0.09	0.10	0.12	0.16

804D (XPET..AP, SCET..-UD)



	D9335	D8330	D8345	∅ 15	∅ 20	∅ 25	∅ 30	∅ 40	∅ 58
P1	■	■	■	0.06	0.07	0.08	0.09	0.10	0.14
P2	■	■	■	0.10	0.12	0.14	0.16	0.19	0.25
P3	■	■	■	0.12	0.14	0.16	0.18	0.22	0.30
P4	■	■	■	0.11	0.13	0.15	0.17	0.21	0.28
K1	■	■	■	0.13	0.15	0.18	0.20	0.24	0.32
K2	■	■	■	0.13	0.15	0.18	0.20	0.24	0.32
K3	■	■	■	0.13	0.15	0.18	0.20	0.24	0.32
K4	■	■	■	0.13	0.15	0.18	0.20	0.24	0.32
K5	■	■	■	0.13	0.15	0.18	0.20	0.24	0.32



INDEXABLE DRILLS – RECOMMENDED CUTTING CONDITIONS

804D (XPET..AP-SD, SCET..-SD)



	D9335	D8330	D8345	ø 15	ø 20	ø 25	ø 30	ø 40	ø 58
P1	■	■	■	0.07	0.08	0.09	0.10	0.12	0.16
P2	■	■	■	0.10	0.12	0.14	0.16	0.19	0.25
P3	■	■	■	0.12	0.14	0.16	0.18	0.22	0.30
P4	■	■	■	–	–	–	–	–	–
K1	▣	▣	▣	0.07	0.08	0.09	0.10	0.12	0.16
K2	▣	▣	▣	0.10	0.12	0.14	0.16	0.19	0.25
K3	▣	▣	▣	0.11	0.13	0.15	0.17	0.20	0.27
K4	▣	▣	▣	0.12	0.14	0.16	0.18	0.22	0.30
K5	▣	▣	▣	0.14	0.16	0.19	0.21	0.25	0.33
M1	■	■	■	0.11	0.13	0.15	0.17	0.21	0.28
M2	■	■	■	0.10	0.12	0.14	0.16	0.19	0.25
M3	■	■	■	0.06	0.07	0.08	0.09	0.10	0.14
M4	■	■	■	0.06	0.07	0.08	0.09	0.10	0.14
S1	▣	▣	▣	0.07	0.08	0.09	0.10	0.12	0.16
S2	▣	▣	▣	0.07	0.08	0.09	0.10	0.12	0.16
S3	▣	▣	▣	0.06	0.07	0.08	0.09	0.10	0.14
S4	▣	▣	▣	0.06	0.07	0.08	0.09	0.10	0.14

805D (XPET..AP, SCET..-UD)



	D9335	D8330	D8345	ø 15	ø 20	ø 25	ø 30	ø 40	ø 58
P1	■	■	■	0.06	0.07	0.08	0.09	0.10	0.14
P2	■	■	■	0.10	0.12	0.14	0.16	0.19	0.25
P3	■	■	■	0.12	0.14	0.16	0.18	0.22	0.30
P4	■	■	■	0.11	0.13	0.15	0.17	0.21	0.28
K1	■	■	■	0.13	0.15	0.18	0.20	0.24	0.32
K2	■	■	■	0.13	0.15	0.18	0.20	0.24	0.32
K3	■	■	■	0.13	0.15	0.18	0.20	0.24	0.32
K4	■	■	■	0.13	0.15	0.18	0.20	0.24	0.32
K5	■	■	■	0.13	0.15	0.18	0.20	0.24	0.32

805D (XPET..AP-SD, SCET..-SD)



	D9335	D8330	D8345	ø 15	ø 20	ø 25	ø 30	ø 40	ø 58
P1	■	■	■	0.07	0.08	0.09	0.10	0.12	0.16
P2	■	■	■	0.10	0.12	0.14	0.16	0.19	0.25
P3	■	■	■	0.12	0.14	0.16	0.18	0.22	0.30
P4	■	■	■	–	–	–	–	–	–
K1	▣	▣	▣	0.07	0.08	0.09	0.10	0.12	0.16
K2	▣	▣	▣	0.10	0.12	0.14	0.16	0.19	0.25
K3	▣	▣	▣	0.11	0.13	0.15	0.17	0.20	0.27
K4	▣	▣	▣	0.12	0.14	0.16	0.18	0.22	0.30
K5	▣	▣	▣	0.12	0.14	0.16	0.18	0.22	0.30
M1	■	■	■	0.11	0.13	0.15	0.17	0.21	0.28
M2	■	■	■	0.10	0.12	0.14	0.16	0.19	0.25
M3	■	■	■	0.06	0.07	0.08	0.09	0.10	0.14
M4	■	■	■	0.06	0.07	0.08	0.09	0.10	0.14
S1	▣	▣	▣	0.07	0.08	0.09	0.10	0.12	0.16
S2	▣	▣	▣	0.07	0.08	0.09	0.10	0.12	0.16
S3	▣	▣	▣	0.06	0.07	0.08	0.09	0.10	0.14
S4	▣	▣	▣	0.06	0.07	0.08	0.09	0.10	0.14

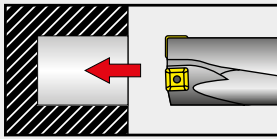

BLIND HOLE DRILLING

For drilling holes deeper than $1 \times DC$ internal cooling is necessary.

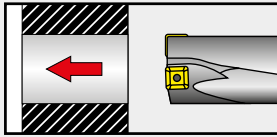

THROUGH HOLE DRILLING

A disc can be produced when the indexable drill exits the material. This disc can be ejected at high speed when the workpiece is rotating. It is essential that the machine is adequately guarded to ensure operator safety

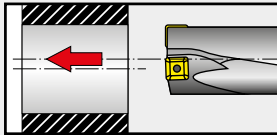

OFF-CENTRE DRILLING

Decrease the feed to lower recommended values for particular inserts. See inserts description pages for indexable drills. Do not exceed radial adjustment values.

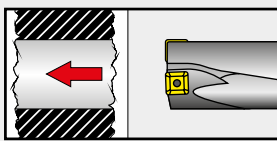

STARTING ON UNEVEN AND CAST SURFACES

Decrease the feed by 50% on entrance for indexable drills until both inserts are engaged.

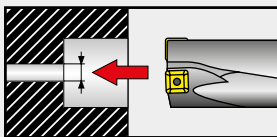

BORING AND DRILLING INTO PILOT HOLES

If a pre-drilled hole is larger than $1/4$ drill diameter, decrease the feed.

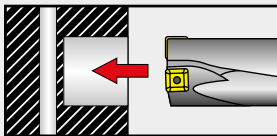

DRILLING CROSS HOLES

Decrease the feed by 50% when drilling across an existing hole. The diameter of existing hole should not be larger than $0.25 \times DC$.

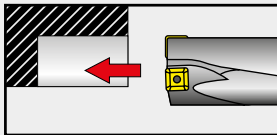

INTERRUPTED CUT AND PLUNGING

Decrease the feed to lower recommended feed values for particular insert. See inserts description site for indexable drills.

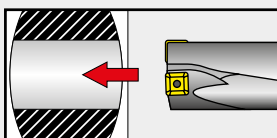

DRILLING ON CURVED SURFACE

Drilling on the centre line can be done with reduced feed rate down to 50 % during entrance and exit.

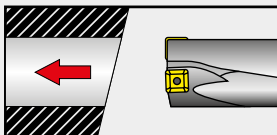

DRILLING ON ANGLED SURFACES

Decrease the feed by 50% on entrance for indexable drills until both inserts are engaged if the angle of entry is more than 5° .

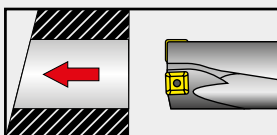

EXIT ON ANGLED SURFACE

Decrease the feed by 50% on exit if angle of exit is more than 5° .

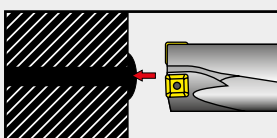

STARTING ON A WELDED SEAM

Facing is recommended before drilling. Decrease the feed by 50 % during drilling of the welded material.

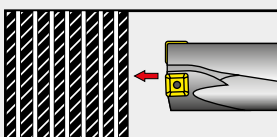

DRILLING OF STACKED MATERIALS

Avoid spaces larger than 0.2 mm between layers. The component must be securely fixed. If necessary reduce the feed.



TROUBLESHOOTING FOR INDEXABLE DRILLS

LOW PERFORMANCE OF DRIVING MOTOR (LOW SPINDLE POWER)	<ul style="list-style-type: none">a) reduce cutting speed = reduction of spindle RPMb) reduce feed rate
EXCESSIVE WEAR OF PERIPHERAL INSERT	<ul style="list-style-type: none">a) reduce cutting speed = reduction of spindle RPMb) choose a more wear resistant gradec) increase coolant volume and pressure
CHIPPING OF PERIPHERAL INSERT	<ul style="list-style-type: none">a) reduce feed rate until peripheral insert is fully engagedb) choose a tougher insert gradec) reduce cutting speed
CHIPPING OF CENTRE INSERT	<ul style="list-style-type: none">a) reduce feed rate during entryb) check the drill and workpiece clamping
CONTINUOUS, BADLY FORMED CHIP	<ul style="list-style-type: none">a) adjust feed rateb) increase cutting speed and simultaneously reduce feed rate
SWARF CONGESTION IN THE FLUTES	<ul style="list-style-type: none">a) increase coolant volume and pressureb) reduce cutting speedc) adjust feed rate



RECOMMENDED DRILL SIZES FOR TAPPING

Metric ISO threads		Recommended drill diameter for	
Thread	Pitch	Cutting tap	Fluteless tap
M16 × 1.0	1.00	15.0	15.5
M16 × 0.75	0.75	15.3	–
M17 × 1.0	1.00	16.0	–
M18	2.50	15.5	16.8
M18 × 2.0	2.00	16.0	–
M18 × 1.5	1.50	16.5	17.3
M18 × 1.0	1.00	17.0	–
M20	2.50	17.5	18.8
M20 × 2.0	2.00	18.0	–
M20 × 1.5	1.50	18.5	19.3
M20 × 1.0	1.00	19.0	–
M22	2.50	19.5	20.8
M22 × 2.0	2.00	20.0	–
M22 × 1.5	1.50	20.5	21.3
M22 × 1.0	1.00	21.0	–
M24	3.00	21.0	22.5
M24 × 2.0	2.00	22.0	–
M24 × 1.5	1.50	22.5	23.3
M27	3.00	24.0	–
M27 × 2.0	2.00	25.0	–
M30	3.50	26.5	–
M30 × 2.0	2.00	28.0	–
M33	3.50	29.5	–
M36	4.00	32.0	–
M36 × 3.0	3.00	33.0	–
M39	4.00	35.0	–
M42	4.50	37.5	–
M42 × 3.0	3.00	39.0	–
M45	4.50	40.5	–
M48	5.00	43.0	–
M48 × 3.0	3.00	45.0	–
M52	5.00	47.0	–
M52 × 3.0	3.00	48.0	–

Inch threads UNC		Recommended drill diameter for	
Thread	Pitch	Cutting tap	Fluteless tap
3/4"	10	16.7	17.8
7/8"	9	19.5	20.8
1"	8	22.2	23.8
1 1/8"	7	25.0	–
1 1/4"	7	28.2	–
1 3/8"	6	31.0	–
1 1/2"	6	34.0	–
1 3/4"	5	39.5	–
2"	4 1/2	45.2	–
2 1/4"	4 1/2	51.6	–
2 1/2"	4	57.2	–

Whitworth pipe threads		Recommended drill diameter for	
Thread	Pitch	Cutting tap	Fluteless tap
G 3/8"	19	15.3	16.0
G 1/2"	14	19.0	20.0
G 5/8"	14	21.0	22.0
G 3/4"	14	24.5	25.5
G 7/8"	14	28.3	29.3
G 1"	11	30.8	32.0
G 1 1/8"	11	35.5	–
G 1 1/4"	11	39.5	–
G 1 3/8"	11	41.8	–
G 1 1/2"	11	45.3	–
G 1 3/4"	11	51.0	–
G 2"	11	57.0	–

Inch threads UNF		Recommended drill diameter for	
Thread	Pitch	Cutting tap	Fluteless tap
3/4"	16	17.5	18.3
7/8"	14	20.5	21.3
1"	12	23.4	24.3
1 1/8"	12	26.5	–
1 1/4"	12	29.8	–
1 3/8"	12	33.0	–
1 1/2"	12	36.0	–



RAILWAY – THREADING ASSORTMENT



**CONTENT**

7		INTRODUCTION & ASSORTMENT HIGHLIGHTS
13	RAILWAY INDUSTRY	PRODUCTION OF NEW RAILWAY WHEELS
20		RAILWAY WHEEL RECONDITIONING
26		AXLES MACHINING
30		STATIONARY & DYNAMIC RAIL MILLING
37		TURNOUTS MACHINING
57		BASE PLATES MACHINING
63		WAGON & BOGIE PARTS MACHINING
73		TURNING ASSORTMENT
92	POSITIVE INSERTS	
129	NEGATIVE INSERTS	
248	MILLING ASSORTMENT	SOLID HM & HSS MILLS
269		ROTARY BURRS
289		INDEXABLE MILLS
433	HOLEMAKING ASSORTMENT	SOLID CARBIDE & HSS DRILLS
456		REAMERS & COUNTERSINKS
477		EXCHANGEABLE HEAD INDEXABLE DRILLS
533	THEARDING ASSORTMENT	MATERIAL SPECIFIC & HSS TAPS
548		TECHNICAL PART



CUTTING TOOL PARAMETERS ACCORDING TO ISO 13399

All cutting tools are defined by a number of parameters according to the standard ISO 13399. This list contains all the parameters used in this catalogue and their definitions.

ISO 13399 is an international cutting tool information standard. It provides dimensions and parameters in a neutral format that is independent of any particular system or company nomenclature. When cutting tools are clearly defined according to a global standard, all types of software can process the electronic data more quickly, improving the quality of communication and helping to make the exchange of information run smoothly. Supporting a common language in our cutting tool descriptions this will assist system to system communication. It will save you a significant amount of time, providing an easier gathering of high-quality data across our 40,000 solid and indexable tools. By using an ISO 13399 compliant system, there will be no need to manually interpret data and key-enter it into your system.

EXAMPLES ONLY!

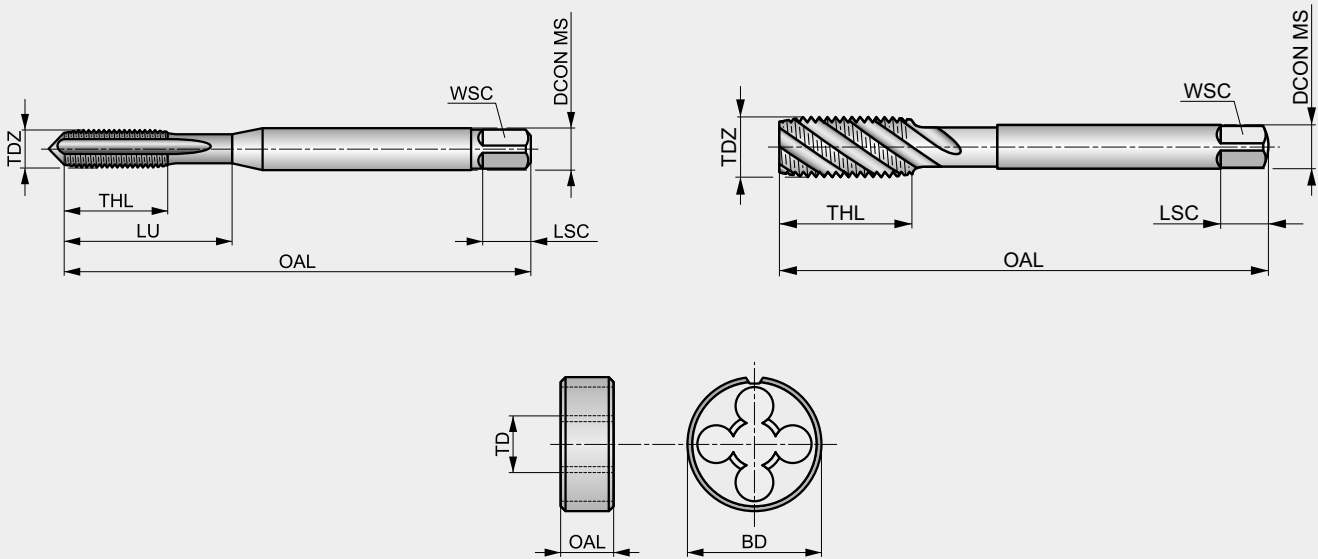

ISO 13399 code	Description
BD	Body diameter
DCON MS	Connection diameter
DRVS	Drive size
LDP	Drill part length
LSC	Clamping length
LU	Usable Length
NOF	Flute count
OAL	Overall length
PHD	Premachined hole diameter
PRAT_HEADER	Description

ISO 13399 code	Description
TCL	Tap chamfer length
TD	Thread diameter
TDZ	Thread diameter size
THL	Threading length
TP	Thread pitch
TPI	Threads per inch
WSC	Clamping width
WSCN	Clamping width minimum
WSCX	Clamping width maximum



MATERIAL SPECIFIC & HSS TAPS



SOLID CARBIDE TAPS – HSS TAPS – PAGE OVERVIEW

1 E256



2



Red SHARK Spiral Point Metric Machine Tap, DIN Standard

High performance through hole tap with reinforced or reduced shank for medium to high strength steel. Unique HSS-E-PM substrate along with TiAlN-Top coating and edge treatment provide superior performance, consistency, extended tool life and higher process security.

3

SHARK

	DIN 371/376	6HX
	2.5xD	5 E-PM
	B 3.5-5	
	TiAlN Top	

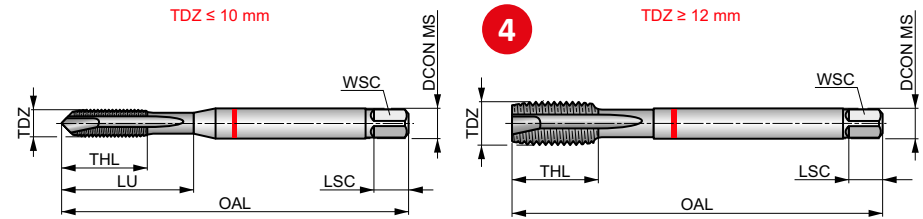

Workpiece material group suitability and starting values for cutting speed (m/min).

P2.3	P3.1	P3.2	P3.3	P4.1	P4.2	P4.3	6	S1.2	S2.1	S3.1	S4.1
■ 27	■ 25	■ 20	■ 17	■ 15	■ 13	■ 10		■ 3	■ 4	■ 3	■ 3

Product	TDZ	TP	OAL	THL	DCON MS	WSC	LSC	NOF	PHD	LU
		(mm)	(mm)	(mm)	(mm)	(mm)	(mm)		(mm)	(mm)
E256M3	3	0.50	56.0	9	3.50	2.70	6	3	2.50	18.00
E256M4	4	0.70	63.0	12	4.50	3.40	6	3	3.30	21.00
E256M5	5	0.80	70.0	13	6.00	4.90	8	3	4.20	25.00
E256M6	6	1.00	80.0	15	6.00	4.90	8	3	5.00	30.00
E256M8	8	1.25	90.0	18	8.00	6.20	9	3	6.80	35.00
E256M10	10	1.50	100.0	20	10.00	8.00	11	3	8.50	39.00
E256M12	12	1.75	110.0	23	9.00	7.00	10	3	10.30	–
E256M16	16	2.00	110.0	25	12.00	9.00	12	3	14.00	–
E256M20	20	2.50	140.0	30	16.00	12.00	15	4	17.50	–

Pos.	Description
1	Designation of taps
2	Product description
3	Illustrative picture
4	Schematic drawing of tool

Pos.	Description
5	Product features
6	Material group recommendations incl. speed and feed guidance
7	Product code
8	Product dimensions



SOLID CARBIDE TAPS – HSS TAPS – ICONS OVERVIEW

General icons

	Primary use		Possible use
--	-------------	--	--------------

Basic standard group (BSG)

ANSI B94.9 – Tap Standard	DIN 352 – Thread Form Standard	DIN 5157 – Pipe Thread Standard
ANSI – Tap Standard	DIN 357 – Nut Tap Standard	DIN Dormer Standard
ANSI Dormer Standard	DIN 371 – Thread Form Standard	DIN Thread Standard (based on size range) DIN 371 if $\varnothing \leq 10$ mm / DIN 376 if $\varnothing \geq 12$ mm
DIN 2174 – Forming Tap Standard	DIN 374 – MF Thread Standard	ISO 2283 – Long Shank Tap Standard
DIN 2181 – Hand Tap Standard	DIN 376 – Thread Form Standard	ISO 2284 – Pipe Tap Standard
DIN 2184-1 – Tap Standard	DIN 40432 – PG Thread Standard	ISO 529 – Tap Standard
DIN 351 – Straight Flute Tap Standard	DIN 5156 – Thread Form Standard	ISO Dormer Standard

Material code (BMC)

HSS-E PM	High Speed Cobalt Powder Metal Tool Material
HSS-E	High Speed Cobalt Steel Tool Material
HSS	High Speed Steel Tool Material
HM	Hard Material (Solid Carbide)

Coating

Bright	Bright (uncoated)	TiAlN Top	Titanium Aluminium Nitride Coating (with smoothing process)
Bright ST	Combination Bright and Steam Tempered	TiAlN	Titanium Aluminium Nitride Coating
Cr	Flash Chrome (Hard Chrome) Plating	TiN	Titanium Nitride Coating
Super B	Special TiAlN Coating (+ WC/C)	TiCN	Titanium Carbon Nitride Coating
ST	Steam Tempered (Steam Oxide) Surface Treatment		

Coolant exit style code (CXSC)

	Through Tool Coolant – Radial Exit
	Through Tool Coolant – Axial Exit

Flute helix angle (FHA)

λ 15°	15° Helix Angle (Flute)	λ 40°	40° Helix Angle (Flute)
λ 27°	27° Helix Angle (Flute)	λ 45°	45° Helix Angle (Flute)
λ 30°	30° Helix Angle (Flute)	λ 48°	48° Helix Angle (Flute)
λ 35°	35° Helix Angle (Flute)		



SOLID CARBIDE TAPS – HSS TAPS – ICONS OVERVIEW

Flute geometry (FDC)

	Fluteless Geometry (Threadforming)
	Oil Grooves Geometry (Threadforming)
	Spiral Flute Geometry

	Spiral Point Geometry
	Straight Flute Geometry

Hand (Cutting direction)

	Left Hand Rotation/Cutting
	Right Hand Rotation/Cutting

Tap chamfer style (TCS)

E 1.5-2	Full Bottoming Tap Chamfer (1.5 – 2 Pitch Lead)
B 3.5-5	Plug Tap Chamfer (3.5 – 5 Pitch Lead)

C 2-3	Semi-Bottoming Tap Chamfer (2 – 3 Pitch Lead)
C 2-3.5	Semi-Bottoming Tap Chamfer (2 – 3.5 Pitch Lead)

A 6-8 D 2-3	Tap Chamfers: A = Taper (6 – 8 Pitch Lead) & C = Semi-Bottoming (2 – 3 Pitch Lead)
C 2-3 D 18-20	Tap Chamfers: C = Semi-Bottoming (2 – 3 Pitch Lead) & D = Nut Style (18 – 20 Pitch Lead)

Thread form type (THFT)

NPSF	Thread Form, American National Pipe Straight Fuel (Dryseal)
NPSM	Thread Form, American National Pipe Straight Mechanical
NPT	Thread Form, American National Pipe Taper
NPTF	Thread Form, American National Pipe Taper Fuel (Dryseal)
BA	Thread Form, British Association Screw Threads
BSF	Thread Form, British Standard Fine

G	Thread Form, British Standard Pipe (BSP)
Rc	Thread Form, British Standard Taper Pipe, 1:16 Taper (BSPT)
BSW	Thread Form, British Standard Whitworth
M	Thread Form, Metric Coarse
MF	Thread Form, Metric Fine
EGM	Thread Form, Metric ISO (Screw Thread Insert Type)

PG	Thread Form, Steel Conduit DIN 40430 (electrical)
UNC	Thread Form, Unified Coarse
UNF	Thread Form, Unified Fine
UN	Thread Form, Unified National

Thread tolerance zone class (TCTR)

6H	DIN Thread Pitch Diameter Tolerance Zone (high basic pitch diameter)
6G	DIN Thread Pitch Diameter Tolerance Zone (low basic pitch diameter)
6HX	DIN Thread Pitch Diameter Tolerance Zone (with increased pitch diameter)

6GX	DIN Thread Pitch Diameter Tolerance Zone (with increased pitch diameter)
2B	Internal Inch Thread Medium Class of Fit
2BX	Internal Inch Thread Medium Class of Fit (with increased pitch diameter)

Medium	Medium Inch Thread Class of Fit
Normal	Normal Fit Class for Pipe Thread

Threading application

	Blind Hole Application
	Through Hole Application
	Through or Blind Hole Application

Usable length diameter ratio (ULDR)



1.5xD	1.5xD Usable Tool Depth to Diameter Ratio
2.5xD	2.5xD Usable Tool Depth to Diameter Ratio
2xD	2xD Usable Tool Depth to Diameter Ratio

3.5xD	3.5xD Usable Tool Depth to Diameter Ratio
3xD	3xD Usable Tool Depth to Diameter Ratio





MATERIAL SPECIFIC & HSS HAND & MACHINE TAPS – TOOL MATERIAL NAVIGATOR





Tool materials

High Speed Steel		A medium-alloyed high speed steel that has good machinability and good performance. HSS exhibits hardness, toughness and wear resistance characteristics that make it attractive in a wide range of applications, for example in drills and taps.
Sintered Cobalt High Speed Steel		HSS-E-PM is a Cobalt High Speed Powder Metal substrate which has been produced using powder metal technology. High speed steel produced by this method exhibits superior toughness and grindability due to the uniform and consistent grain structure. High performance taps and end mills have a particular advantage when manufactured from this substrate.

Surface Treatments

Bright (uncoated)		Bright finish (uncoated surface) improves chip flow in soft or non-ferrous materials and maintains sharp cutting edges in abrasive materials.
Combination Bright and Steam Tempered		Combination of bright and steam tempering can be effective as the blue oxide more porous surface acts to retain and pull cutting fluid into the hole while the bright surface assists in chip evacuation. This combination is achieved by grinding the bright surface after tempering.
Steam Tempering		Steam tempering gives a strongly adhering blue oxide surface that acts to retain cutting fluid and prevent chip to tool welding, thereby counteracting the formation of a built-up edge. Steam tempering can be applied to any bright tool but is most effective on drills and taps.

Surface Coatings

Titanium Nitride (TiN)		Titanium Nitride is a gold coloured ceramic coating applied by physical vapour deposition (PVD). High hardness combined with low friction properties ensures considerably longer tool life, or alternatively, better cutting performance from tools which have not been coated. TiN coatings are used mainly for drills and taps.
Titanium Aluminium Nitride Coatings (TiAlN & TiAlN-Top)	 	Titanium Aluminium Nitride is a multi layer ceramic coating applied by PVD coating technology, which exhibits high toughness and oxidation stability. These properties make it ideal for higher speeds and feeds, while at the same time improving tool life. TiAlN is used in drilling, tapping, and milling applications and can be suitable for use when machining without coolant. TiAlN-Top coating is the same as TiAlN but with a post-coating process designed to smooth out imperfections, enhance chip flow and reduce built up edge.
Super-B Coating (TiAlN/WC/C)		Super B is a Titanium Aluminium Nitride + Tungsten Carbide + Carbon Coating used for wet and minimal lubrication machining in drilling, milling and tapping applications. Very effective for cast iron, hardened steels and heat resistant super alloys.
Chromium Nitride Coating (CrN)		Hard chromium (Cr) for cutting tool applications provides excellent wear and abrasion resistance due to lowering the coefficient of friction. Only designed for machining soft and gummy materials to promote chip flow and to prevent workpiece materials from sticking to the tool. Hard chromium increases the surface hardness of the tool and is especially effective for tapping soft structural steels, copper and brass materials.



Thread form (THFT)																			
Basic standard group (BSG)	DIN 352	DIN 376	DIN 371/376	DIN	DIN 371/376	DIN													
Thread tolerance class (TCTR)	6HX	6H	6HX	6HX	6HX	6HX													
Threading application																			
Usable length (ULDR)	1.5xD	1.5xD	2.5xD	2.5xD	2.5xD	1.5xD													
Material code (BMC)	HSS-E	HSS-E PM	HSS-E PM	HSS-E PM	HSS-E PM	HSS-E PM													
Tap chamfer style (TCS)	C 2-3	C 2-3	B 3.5-5	B 3.5-5	C 2-3	C 2-3													
Flute Geometry (FDC)																			
Flute helix angle (FHA)		λ 15°			λ 45°	λ 15°													
Hand (Cutting direction)																			
Coating		Bright	TiAlN Top	TiAlN Top	TiAlN Top	TiAlN Top													
Product Family Code																			
	E102	E258	E256	E334	E261	E335													
	M3 – M30	M4 – M36	M3 – M20	M3 – M12	M3 – M20	M3 – M12													
	542	544	543	546	545	547	42	43	44	45	46	47	48						
P	P1	■																	
	P2	■	■	■	■	■													
	P3	■	■	■	■	■	■												
	P4	■	■	■	■	■	■												
M	M1	■																	
	M2	■																	
	M3	■																	
	M4	■																	
K	K1	■																	
	K2	■																	
	K3	■																	
	K4	■																	
	K5	■																	
N	N1		■																
	N2		■																
	N3																		
	N4																		
	N5																		
S	S1	■		■	■	■													
	S2	■		■	■	■													
	S3	■		■	■	■													
	S4	■		■	■	■													
H	H1																		
	H2																		
	H3				■														
	H4						■												

SHARK

MATERIAL SPECIFIC APPLICATION TAPS



ALLOY STEELS

HIGH STRENGTH STEELS

NEW



RED SHARK

BLACK SHARK

- **SURFACE TREATMENT**
Bright or TiAlN-Top coated with an additional edge treatment.
- **FLUTE GEOMETRY**
Available in spiral point for through holes and spiral flute (45° angle) for blind holes.
- **BACK TAPERED**
Back taper on spiral flute taps further facilitates chip evacuation, reducing chipping on the last threads of the taps and also reducing torque when the tap reverses.
- **CUTTING GEOMETRY (SPIRAL FLUTE TAPS)**
The special three-radii profile with a constant rake angle along the flute length leads to better control of cutting properties and prevents nest formation of chips.
- **TAPPING ATTACHMENT (RECOMMENDATION)**
When using spiral flute Red Shark taps, it is recommended to use a tool holder with minimal float or soft start.
- **THREAD FORMS**
Metric
- **PRODUCT CODES**
E255, E256, E260, E261

- **SURFACE TREATMENT**
TiAlN-Top coating with an additional edge treatment.
- **FLUTE GEOMETRY**
Spiral point or low helix spiral flute geometries with low rake angle for good chip control and edge strength.
- **CUTTING GEOMETRY (SPIRAL FLUTE TAPS)**
The special three-radii profile with a constant rake angle along the flute length leads to better control of cutting properties and prevents nest formation of chips.
- **TAPPING ATTACHMENT (RECOMMENDATION)**
When using Black Shark taps, it is recommended to use synchronized (rigid) tapping.
- **THREAD FORMS**
Metric
- **PRODUCT CODES**
E334, E335



SHARK

MATERIAL SPECIFIC APPLICATION TAPS

Dormer's application-based ranges of DIN taps, branded Shark Line, are renowned for their high performance and are easily recognizable by their colored rings, denoting recommendation for use on specific materials.

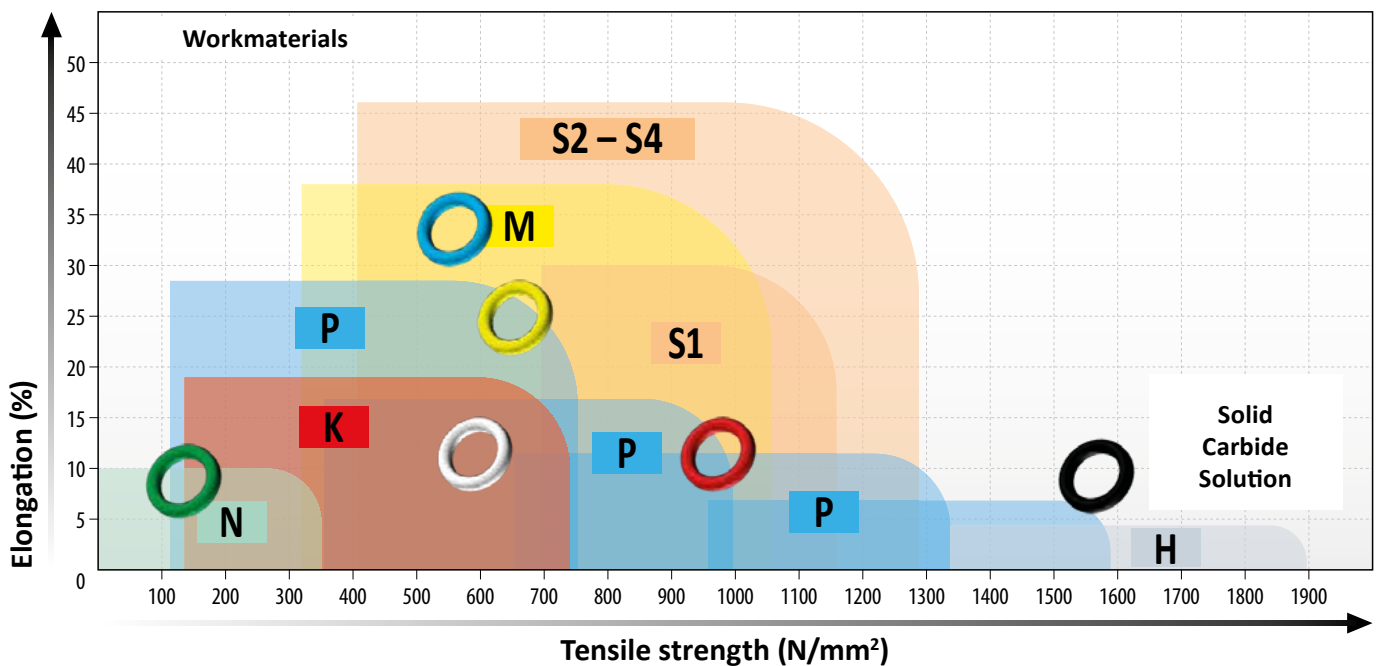



SHARK

MATERIAL SPECIFIC APPLICATION TAPS

FEATURES AND BENEFITS

COLOUR RING CODING

- The colour ring on the tool shank identifies suitability for specific materials and enables **quick and easy tool selection**.

EDGE TREATMENT

(Black, Red, Yellow, Blue Shark)

- Spiral flute taps incorporate a special edge treatment to increase strength and reduce the chance of micro-chipping on the cutting edges. This considerably improves **performance and tool life** as well as process security.

MATERIAL

Shark taps are manufactured from a unique powder metallurgy tool steel different from any other HSS-E-PM. This provides an unbeatable combination of toughness and edge strength, allowing the taps to perform at higher cutting temperatures while offering excellent performance and longer tool life.

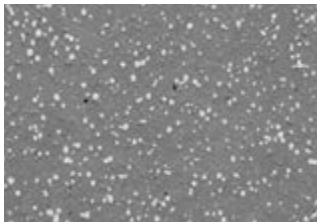

Unique HSS-E-PM material used for **SHARK TAPS** (note the evenly dispersed grain structure).

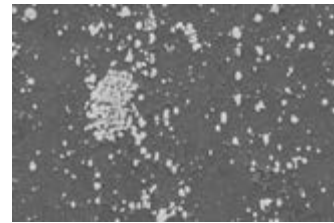

Traditional HSS-E (M35) material.





E102



HSS-E Straight Flute Serial Hand Taps, Metric, DIN Standard

Ideal for hand tapping tough materials. The straight flute design makes it ideal for both through and blind holes. Available as a set of three serial taps, which should be used one after the other to create the full thread. Steam tempered surface acts to retain cutting fluid to improve lubrication and provide smoother cutting.

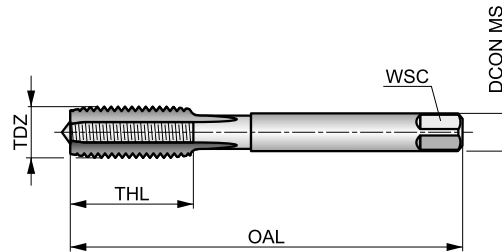

	DIN 352	6HX
	1.5xD	HSS-E

Workpiece material group suitability.

P1.1	P1.2	P1.3	P2.1	P2.2	P2.3	P3.1	P3.2	P3.3	P4.1	P4.2	M1.1	M1.2	M2.1
☑	☑	☑	☑	☑	☑	☑	☑	☑	☑	☑	☑	☑	☑
M2.2	M3.1	M3.2	M3.3	M4.1	K1.1	K1.2	K1.3	K2.1	K2.2	K2.3	K3.1	K3.2	K3.3
☑	☑	☑	☑	☑	☑	☑	☑	☑	☑	☑	☑	☑	☑
K4.1	K4.2	K4.3	K5.1	K5.2	K5.3	S1.1	S2.1	S3.1	S4.1				
☑	☑	☑	☑	☑	☑	☑	☑	☑	☑				

No4 with pilot guide.

Product	TDZ	TP	OAL	THL	DCON MS	WSC	NOF	PHD
		(mm)	(mm)	(mm)	(mm)	(mm)		(mm)
E102M3N08	3	0.50	40.0	10	3.50	2.70	3	2.50
E102M4N08	4	0.70	45.0	12	4.50	3.40	3	3.30
E102M5N08	5	0.80	50.0	14	6.00	4.90	3	4.20
E102M6N08	6	1.00	56.0	16	6.00	4.90	3	5.00
E102M8N08	8	1.25	63.0	19	6.00	4.90	3	6.80
E102M10N08	10	1.50	70.0	22	7.00	5.50	3	8.50
E102M12N08	12	1.75	75.0	25	9.00	7.00	4	10.30
E102M14N08	14	2.00	80.0	25	11.00	9.00	4	12.00
E102M16N08	16	2.00	80.0	25	12.00	9.00	4	14.00
E102M18N08	18	2.50	95.0	32	14.00	11.00	4	15.50
E102M20N08	20	2.50	95.0	32	16.00	12.00	4	17.50
E102M24N08	24	3.00	110.0	38	18.00	14.50	4	21.00
E102M27N08	27	3.00	110.0	38	20.00	16.00	4	24.00
E102M30N08	30	3.50	125.0	45	22.00	18.00	4	26.50



E256



Red SHARK Spiral Point Metric Machine Tap, DIN Standard

High performance through hole tap with reinforced or reduced shank for medium to high strength steel. Unique HSS-E-PM substrate along with TiAlN-Top coating and edge treatment provide superior performance, consistency, extended tool life and higher process security.

SHARK

	DIN 371/376	6HX
	2.5xD	HSS-E-PM
	B 3.5-5	

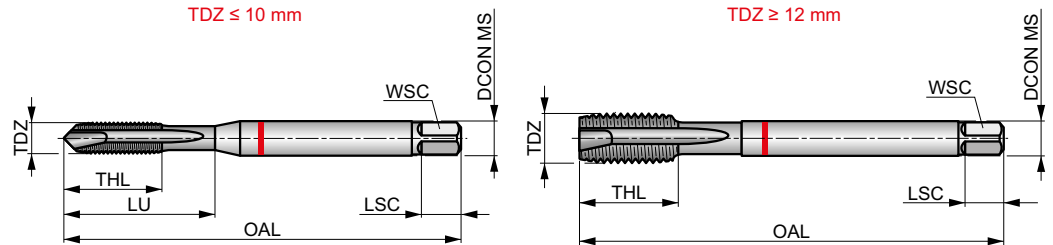

Workpiece material group suitability and starting values for cutting speed (m/min).

P2.3 ■ 27	P3.1 ■ 25	P3.2 ■ 20	P3.3 ■ 17	P4.1 ■ 15	P4.2 ■ 13	P4.3 ▣ 10	S1.2 ▣ 3	S2.1 ▣ 4	S3.1 ▣ 3	S4.1 ▣ 3
---------------------	---------------------	---------------------	---------------------	---------------------	---------------------	---------------------	--------------------	--------------------	--------------------	--------------------

Product	TDZ	TP	OAL	THL	DCON MS	WSC	LSC	NOF	PHD	LU
E256M3	3	0.50	56.0	9	3.50	2.70	6	3	2.50	18.00
E256M4	4	0.70	63.0	12	4.50	3.40	6	3	3.30	21.00
E256M5	5	0.80	70.0	13	6.00	4.90	8	3	4.20	25.00
E256M6	6	1.00	80.0	15	6.00	4.90	8	3	5.00	30.00
E256M8	8	1.25	90.0	18	8.00	6.20	9	3	6.80	35.00
E256M10	10	1.50	100.0	20	10.00	8.00	11	3	8.50	39.00
E256M12	12	1.75	110.0	23	9.00	7.00	10	3	10.30	–
E256M16	16	2.00	110.0	25	12.00	9.00	12	3	14.00	–
E256M20	20	2.50	140.0	30	16.00	12.00	15	4	17.50	–



E258

DORMER

HSS-E-PM 15° Spiral Flute Machine Tap, Metric, DIN Standard

Slow spiral flute tap for up to 1.5xD deep blind holes. With 15° helix for more stability threading in harder and higher strength steels. The reduced shank increases the reach of the tap.

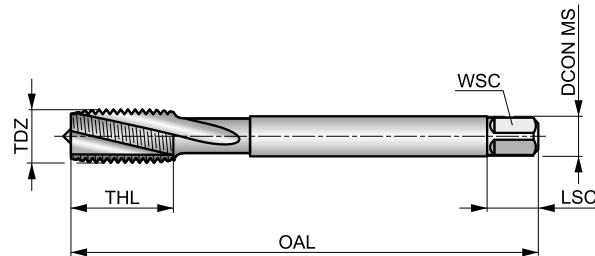

	DIN 376	6H
	1.5xD	HSS-E PM
C 2-3		λ 15°
R	Bright	

Workpiece material group suitability and starting values for cutting speed (m/min).

P2.2 ■ 16	P2.3 ■ 14	P3.1 ■ 10	P3.2 ■ 8	P4.1 ■ 6	N1.3 ■ 6	N2.1 ■ 23	N2.2 ■ 21	N2.3 ■ 15
---------------------	---------------------	---------------------	--------------------	--------------------	--------------------	---------------------	---------------------	---------------------

Product	TDZ	TP	OAL	THL	DCON MS	WSC	LSC	NOF	PHD
		(mm)	(mm)	(mm)	(mm)	(mm)	(mm)		(mm)
E258M4	4	0.70	63.0	12	2.80	2.10	5	3	3.30
E258M5	5	0.80	70.0	13	3.50	2.70	6	3	4.20
E258M6	6	1.00	80.0	15	4.50	3.40	6	3	5.00
E258M8	8	1.25	90.0	18	6.00	4.90	8	3	6.80
E258M10	10	1.50	100.0	20	7.00	5.50	8	3	8.50
E258M12	12	1.75	110.0	23	9.00	7.00	10	3	10.30
E258M14	14	2.00	110.0	25	11.00	9.00	12	3	12.00
E258M16	16	2.00	110.0	25	12.00	9.00	12	3	14.00
E258M18	18	2.50	125.0	30	14.00	11.00	14	3	15.50
E258M20	20	2.50	140.0	30	16.00	12.00	15	3	17.50
E258M22	22	2.50	140.0	34	18.00	14.50	17	4	19.50
E258M24	24	3.00	160.0	38	18.00	14.50	17	4	21.00
E258M27	27	3.00	160.0	38	20.00	16.00	19	4	24.00
E258M30	30	3.50	180.0	45	22.00	18.00	21	4	26.50
E258M36	36	4.00	200.0	55	28.00	22.00	25	4	32.00



E261



Red SHARK 45° Spiral Flute Metric Machine Tap, DIN Standard

High performance blind hole tap for medium to high strength steels. Unique HSS-E-PM substrate with TiAlN-Top coating and additional edge treatment provide superior performance, consistency and extended tool life. Extra back taper further facilitates chip evacuation and reduces torque on tap reversal.

SHARK

	DIN 371/376	6HX
	2.5xD	HSS-E PM
	C 2-3	λ 45°
	TiAlN Top	

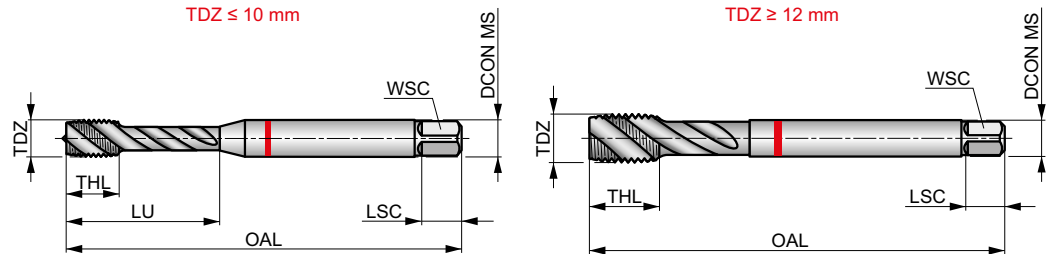

Workpiece material group suitability and starting values for cutting speed (m/min).

P2.3 ■ 26	P3.1 ■ 24	P3.2 ■ 19	P3.3 ■ 16	P4.1 ■ 14	P4.2 ■ 12	P4.3 ■ 9	S1.2 ■ 2	S2.1 ■ 3	S3.1 ■ 2	S4.1 ■ 2
---------------------	---------------------	---------------------	---------------------	---------------------	---------------------	--------------------	--------------------	--------------------	--------------------	--------------------

Product	TDZ	TP	OAL	THL	DCON MS	WSC	LSC	NOF	PHD	LU
E261M3	3	0.50	56.0	6	3.50	2.70	6	3	2.50	18.00
E261M4	4	0.70	63.0	7	4.50	3.40	6	3	3.30	21.00
E261M5	5	0.80	70.0	8	6.00	4.90	8	3	4.20	25.00
E261M6	6	1.00	80.0	10	6.00	4.90	8	3	5.00	30.00
E261M8	8	1.25	90.0	12	8.00	6.20	9	3	6.80	35.00
E261M10	10	1.50	100.0	15	10.00	8.00	11	3	8.50	39.00
E261M12	12	1.75	110.0	16	9.00	7.00	10	3	10.30	–
E261M16	16	2.00	110.0	20	12.00	9.00	12	4	14.00	–
E261M20	20	2.50	140.0	25	16.00	12.00	15	4	17.50	–



E334

DORMER



Black SHARK Spiral Point Metric Machine Tap, DIN Standard

High performance through hole tap with reinforced or reduced shank designed for efficient tapping in high strength steels and titanium alloys. Unique HSS-E-PM substrate, TiAlN-Top coating and an additional edge treatment provide high process security, superior performance, consistency and extended tool life.

SHARK

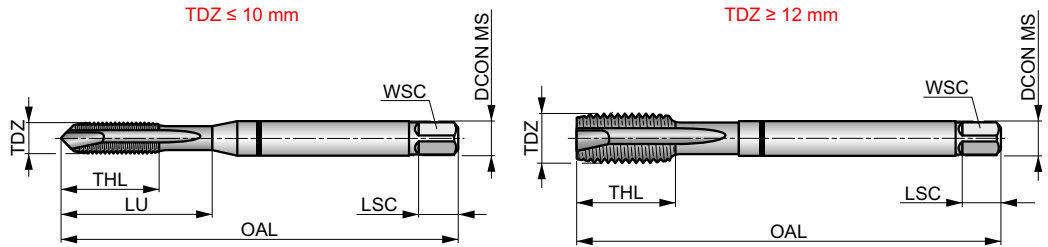

Workpiece material group suitability and starting values for cutting speed (m/min).

P3.3 ■ 17	P4.2 ■ 13	P4.3 ■ 10	S1.2 ■ 13	S1.3 ■ 8	S3.1 ■ 5	S3.2 ■ 3	H3.1 ▣ 7
---------------------	---------------------	---------------------	---------------------	--------------------	--------------------	--------------------	--------------------

Product	TDZ	TP	OAL	THL	DCON MS	WSC	LSC	NOF	PHD	LU
E334M3	3	0.50	63.0	12	4.50	3.40	6	3	2.50	12.00
E334M4	4	0.70	70.0	17	6.00	4.90	8	3	3.30	17.00
E334M5	5	0.80	80.0	20	6.00	4.90	8	3	4.20	20.00
E334M6	6	1.00	90.0	24	8.00	6.20	9	3	5.00	24.00
E334M8	8	1.25	100.0	32	10.00	8.00	11	3	6.80	32.00
E334M10	10	1.50	100.0	20	10.00	8.00	11	3	8.50	39.00
E334M12	12	1.75	110.0	23	9.00	7.00	10	4	10.30	–



E335



Black SHARK 15° Spiral Flute Metric Machine Tap, DIN Standard

High performance blind hole tap for efficient tapping in high strength steels and titanium alloys. A 15° slow spiral allows the chips to be pulled slightly upwards, yet without weakening the cutting edge, as higher spiral taps would. Unique HSS-E-PM substrate along with TiAlN-Top coating for superior performance.

SHARK

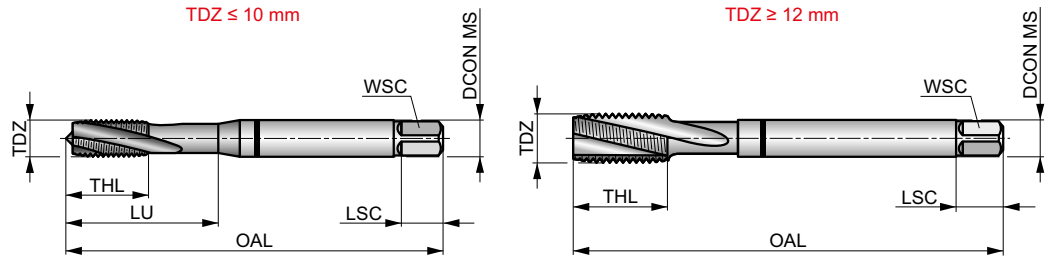

Workpiece material group suitability and starting values for cutting speed (m/min).

P3.3 ■ 16	P4.2 ■ 12	P4.3 ■ 9	S1.2 ■ 12	S1.3 ■ 7	S3.1 ■ 4	S3.2 ■ 2	H3.1 ▣ 6
---------------------	---------------------	--------------------	---------------------	--------------------	--------------------	--------------------	--------------------

Product	TDZ	TP	OAL	THL	DCON MS	WSC	LSC	NOF	PHD	LU
E335M3	3	0.50	63.0	12	4.50	3.40	6	3	2.50	12.00
E335M4	4	0.70	70.0	13	6.00	4.90	8	3	3.30	13.00
E335M5	5	0.80	80.0	15	6.00	4.90	8	3	4.20	15.00
E335M6	6	1.00	90.0	18	8.00	6.20	9	3	5.00	18.00
E335M8	8	1.25	100.0	20	10.00	8.00	11	3	6.80	20.00
E335M10	10	1.50	100.0	20	10.00	8.00	11	3	8.50	39.00
E335M12	12	1.75	110.0	23	9.00	7.00	10	4	10.30	-









GENERAL TECHNICAL INFORMATION

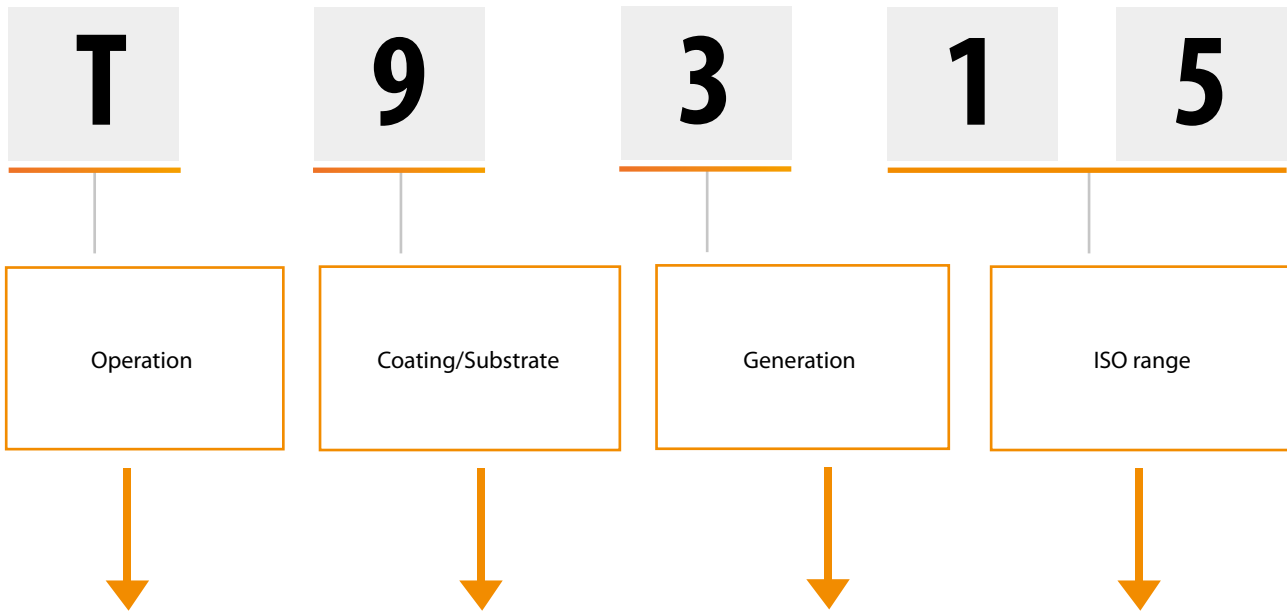

**CONTENT**

7		INTRODUCTION & ASSORTMENT HIGHLIGHTS
13	RAILWAY INDUSTRY	PRODUCTION OF NEW RAILWAY WHEELS
20		RAILWAY WHEEL RECONDITIONING
26		AXLES MACHINING
30		STATIONARY & DYNAMIC RAIL MILLING
37		TURNOUTS MACHINING
57		BASE PLATES MACHINING
63		WAGON & BOGIE PARTS MACHINING
73		TURNING ASSORTMENT
92	POSITIVE INSERTS	
129	NEGATIVE INSERTS	
248	MILLING ASSORTMENT	SOLID HM & HSS MILLS
269		ROTARY BURRS
289		INDEXABLE MILLS
433	HOLEMAKING ASSORTMENT	SOLID CARBIDE & HSS DRILLS
456		REAMERS & COUNTERSINKS
477		EXCHANGEABLE HEAD INDEXABLE DRILLS
533	THEARDING ASSORTMENT	MATERIAL SPECIFIC & HSS TAPS
548		TECHNICAL PART



Operation		Coating/Substrate		Generation	ISO range
D	Drilling	0 PVD 1 CVD	Special application	1 – 9	01 – 50
M	Milling	2 PVD 3 CVD	Free		
T	Turning	4 PVD 5 CVD	Group K, H		 01 – 05
G	Grooving and Parting off	6 PVD 7 CVD	Group M, S		 05 – 10
		8 PVD 9 CVD	Universal		 10 – 20
		B	CBN		 20 – 30
		C	Ceramic		 30 – 40
		D	PCD		 40 – 50
		T	Cermet		



TURNING GRADES

Grade Identification	Area of Application	Application	Feed	Cutting speed	Resistance to adverse Working Conditions	Coating	Colour	Substrate	Coolant benefit	Grade description
T9226	P15 - P35	■				MT-CVD	Yellow	FGM	+++	Grade designed for heavy roughing applications. A versatile grade with high resistance to mechanical damage and retains very good wear resistance. Usable at lower cutting speeds.
	M10 - M30	■								
	K15 - K35	■								
	S15 - S25	□								
T9310	P01 - P15	■				MT-CVD	Black	FGM	++	Grade with high abrasion resistance which can be used for slightly interrupted cutting. It will be used for finishing or semi-roughing operations. This material can also be used for roughing operations provided the machine-tool-workpiece configuration is sufficiently rigid.
	K05 - K20	■								
	H10 - H20	■								
T9315	P05 - P25	■				MT-CVD	Black	FGM	++	A versatile grade with excellent wear resistance properties even under intense cutting conditions. It can also be used for operations with interrupted cuts. With its well balanced properties this grade can be first choice for a wide range of turning operations. Not suited to low cutting speeds.
	K05 - K25	■								
	H10 - H20	■								
T9316	P10 - P20	■				MT-CVD	Yellow	FGM	+++	Grade designed for railway applications. A versatile grade with excellent wear resistance properties. Usable at lower and high cutting speeds.
	M05 - M15	■								
	K10 - K30	■								
	H15 - H25	■								
T9325	P15 - P35	■				MT-CVD	Black	FGM	++	From a technological perspective this is an extremely versatile grade with high resistance to mechanical damage in adverse cutting conditions and retains excellent wear resistance. The correct application of this material requires high cutting speeds.
	M10 - M30	■								
	K15 - K35	■								
	S10 - S20	■								
T9335	P20 - P45	■				MT-CVD	Black	FGM	+++	One of the toughest grades which is especially suitable for adverse cutting conditions at medium to high feed rates and medium cutting speeds. Compared to its predecessors, M15 - M40 it is not only tougher, but also more abrasion resistant which will be useful when using intensive cutting conditions.
	M15 - M40	■								
	S15 - S25	■								
T7325	P15 - P35	■				MT-CVD	Black	FGM	+++	One of the most universal turning grades. Especially designed for stainless steel machining. Optimal balance between wear resistance and performance reliability. Suitable for broad variety of application in turning operations.
	M10 - M25	■								
	S10 - S25	■								
T7335	P20 - P40	■				MT-CVD	Black	FGM	+++	Grade with functionally graded substrate, featuring very high operational reliability and very good wear-resistance. It is best suited to use in the machining of very tough M20 - M40 materials.
	M20 - M40	■								
	S15 - S25	■								
T5305	P05 - P15	■				MT-CVD	Black	H	+	Grade with very high resistance to chemical wear; suitable for finishing operations using high cutting speeds. With its high abrasion resistance, it is also suitable for productive K01 - K15, machining of hardened and treated materials.
	K01 - K15	■								
	H05 - H15	■								
T5315	P10 - P25	■				MT-CVD	Black	H	+	Grade intended primarily for productive machining which has high abrasion resistance and good operational reliability. Due to its properties, this material is particularly suitable for roughing and finishing operations for good or slightly adverse cutting conditions.
	K10 - K25	■								
	H15 - H25	■								
6630	P10 - P35	■				MT-CVD	Yellow	FGM	+++	A versatile turning material which is particularly suitable for applications with medium to low cutting speeds and medium to higher feed rates. It is an ideal first choice for conventional machines. It can be used for semi-roughing, but also for roughing and finishing operations
	M22 - M32	■								
	K22 - K30	■								
6640	P20 - P40	■				MT-CVD	Yellow	H	+++	One of the toughest turning materials which can be used especially in roughing operations, or where operational reliability under adverse cutting conditions is a priority. Another ideal choice for machines working with low to medium cutting speeds and medium to high feed rates.
	M20 - M35	■								
	K25 - K40	■								



TURNING GRADES

Grade Identification	Area of Application	Application	Feed	Cutting speed	Resistance to adverse Working Conditions	Coating	Colour	Substrate	Coolant benefit	Grade description
T6310	P01 - P15	■				PVD	grey	ultra submicron H	+++	High wear resistant turning grade with top PVD coating. Suitable for finishing operation and applications, where sharp cutting edge together with high flank wear resistance is of high importance
	M01 - M15	■								
	K05 - K20	■								
	N05 - N20	■								
	S01 - S15	■								
	H01 - H15	■								
T8315	P05 - P20	☑				PVD	yellow	submicron H	++	Grade featuring excellent abrasion resistance while maintaining above average operational reliability, it is suitable for machining at medium to high cutting speeds in short chipping harder materials.
	M05 - M20	■								
	K05 - K25	■								
	N05 - N25	■								
	S05 - S15	☑								
	H05 - H15	■								
T8430 NEW	P20 - P40	■				PVD	brown	submicron H	+++	Undoubtedly the most versatile cutting material, this is useful for machining of all types of machined materials and is practically applicable in almost all types of turning operations. Its main benefits are its high operational reliability and very good frictional properties; it is therefore suitable for applications at medium and lower cutting speeds.
	M20 - M35	■								
	K25 - K40	☑								
	N15 - N30	☑								
	S15 - S25	☑								
	H15 - H25	☑								
T8345	P30 - P50	■				PVD	yellow	submicron H	+++	This is the toughest turning grade, which is intended mainly for machining under the worst cutting conditions and in applications with the highest requirements for operating reliability. Because of these properties, this material is recommended for lower cutting speeds.
	M20 - M40	☑								
	K30 - K40	☑								
	S20 - S30	☑								
HF7	M10 - M20	☑				-	grey	submicron H	++	Uncoated grade which is primarily designed for machining non-ferrous metals; but can also be used for other machined materials (except steel). This material can be used in turning, milling, and even boring.
	K10 - K25	■								
	N10 - N25	■								



MILLING GRADES

Grade Identification	Area of Application	Application	Feed	Cutting speed	Resistance to adverse Working Conditions	Coating	Colour	Substrate	Coolant benefit	Grade description
M9315	P05 – P25	■				MT-CVD	█	H	---	Milling grade with high abrasion resistance even at high thermal loads, main application area is higher cutting speeds with medium or small depths of cut.
	K10 – K30	■	▧	▧	▧					
	H10 – H20	▣								
M9325	P10 – P30	■				MT-CVD	█	H	---	This grade has an ideal balance between wear resistance and toughness, it is mainly designed for roughing operations. Advantages are excellent wear resistance even at relatively high cutting speeds with excellent reliability, this grade is more suitable for applications using higher speeds and lower feed rates.
	K10 – K30	■	▧	▧	▧					
	H15 – H20	▣								
M9340	P35 – P50	■				MT-CVD	█	H	---	A very tough grade, where the main advantage is the high strength of the cutting edge and resistance to adverse cutting conditions. Although this material has an MT-CVD M30 – M40 coating, it is possible to use emulsion cooling for its application, especially in optimum cutting conditions.
	M30 – M40	■	▧	▧	▧					
	S15 – S20	■								
M5315	P05 – P20	▣				MT-CVD	█	H	---	One of the most abrasion-resistant milling grades which should be used under stable conditions. Its main advantage is the extremely high resistance to thermal stress and abrasive K05 – K25 wear. It is mainly used for machining hard and very hard materials, particularly cast iron.
	K05 – K25	■	▧	▧	▧					
	H05 – H20	■								
M8310	P01 – P10	■				PVD	█	ultra submicron H	-	Grade specially developed for copy milling, featuring high resistance to abrasion. It is suitable for machining at higher cutting speeds under stable cutting conditions, and for machining virtually all groups of machined materials (particularly stronger and harder materials).
	M01 – M10	▣	▧	▧	▧					
	K01 – K10	■	▧	▧	▧					
	H05 – H15	▣								
8215	P10 – P20	■				PVD	█	submicron H	+ / -	One of the most versatile milling grades, in terms of both the range of workpiece materials and the range of possible applications. It is characterised by high wear resistance and operational reliability. Its other advantages include excellent resistance to cracking induced by temperature shock. With its unique properties, this material is undoubtedly one of the pillars of the milling range.
	M10 – M20	▣	▧	▧	▧					
	K10 – K25	■	▧	▧	▧					
	N10 – N25	■	▧	▧	▧					
	S10 – S15	▣								
M8325	P20 – P40	■				PVD	█	S	-	The main application area of this grade is machining all kinds of steels (including stainless) in the "soft state". It can also be used for machining softer cast irons. Suitable for M15 – M30 machining at medium speeds under average cutting conditions.
	M15 – M30	▣	▧	▧	▧					
M8330	P20 – P40	■				PVD	█	submicron H	+ / -	This grade is universal and can be used for machining various types of materials. However, it's priority application area lies within steels and ductile cast irons. It is recommended for milling at medium speeds under unstable cutting conditions.
	M20 – M35	■	▧	▧	▧					
	K20 – K40	■	▧	▧	▧					
	N15 – N30	▣	▧	▧	▧					
	S15 – S25	▣								
M8340	P25 – P50	■				PVD	█	submicron H	+ / -	One of the toughest grade dedicated for machining with lower cutting speed and unfavorable conditions. This grade is ideal for all operations where the main requirement is for a tough cutting edge.
	M20 – M40	■	▧	▧	▧					
	K20 – K40	▣	▧	▧	▧					
	S20 – S30	■								



MILLING GRADES

Grade Identification	Area of Application	Application	Feed	Cutting speed	Resistance to adverse Working Conditions	Coating	Colour	Substrate	Coolant benefit	Grade description
M8345	P30 – P50	■				PVD	Dark Purple	H	-	This grade has exceptional operational reliability and is designed for heavy cuts in unfavourable conditions in difficult and tough materials.
	M30 – M40	■								
M6330	P20 – P35	■				PVD	Yellow	H	+ / -	Milling grade with extraordinary service reliability. Especially suitable for machining of hard to machine materials. Powerful in applications where unfavourable conditions and heavy cuts dominate.
	M20 – M35	■								
	S20 – S30	■								
M4303	P01 – P10	▣				PVD	Dark Grey	ultra submicron H	-	The most wear resistant grade for mold & die applications. Offers exceptional performance at high cutting speeds and low feeds in stable cutting conditions. Suitable for finishing operations in difficult workpiece materials.
	K01 – K10	■								
	N01 – N10	▣								
M8326	P20 – P40	■				PVD	Dark Purple	H	-	Special grade for heavy duty. The main application area of this grade is machining all kinds of steels (including stainless) in the „soft state“. It can also be used for machining softer cast irons. Suitable for M15 – M30 machining at medium speeds under average cutting conditions.
	M15 – M30	▣								
M8346	P30 – P50	■				PVD	Dark Purple	H	-	Special grade for heavy duty. This grade has exceptional operational reliability and is designed for heavy cuts in unfavourable conditions in difficult and tough materials.
	M30 – M40	■								
7310	P01 – P10	■				PVD	Yellow	ultra submicron H	-	One of the most abrasion-resistant materials, it is highly versatile and finds its application especially in finishing operations, i.e. at high cutting speeds and small chip cross-sections taken under ideal cutting conditions. The ideal choice for machining hard to very hard materials.
	M01 – M10	▣								
	K01 – K10	■								
7330	P20 – P35	■				PVD	Dark Purple	submicron H	-	A very versatile material suitable for finishing as well as for semi-roughing operations. It is a material which, while maintaining very good abrasion resistance, also retains very good operational reliability.
	M20 – M30	▣								
	K20 – K30	■								
	H15 – H20	▣								
HF7	M10 – M20	▣				-	Dark Grey	submicron H	+ +	Uncoated grade which is primarily designed for machining non-ferrous metals; can also be used for other machined materials (except steel). This grade can be used in turning, milling, and even boring.
	K10 – K25	■								
	N10 – N25	■								
S30	P25 – P30	■				-	Grey	S	+ / -	Uncoated material with good resistance to cratering. It is designed exclusively for machining carbon and alloy steels at low cutting speeds.



DRILLING GRADES

Grade Identification	Area of Application	Application	Feed	Cutting speed	Resistance to adverse Working Conditions	Coating	Colour	Substrate	Coolant benefit	Grade description
D9335	P20 - P35	■				MT-CVD	Black	FGM	+++	This grade is recommended for the peripheral insert in indexable drills, it is more suited to higher cutting speeds and feeds.
	M15 - M30	■								
	K15 - K35	■								
	S10 - S20	■								
D8330	P20 - P35	■				PVD	Yellow	submicron H	+++	This is a universal grade for the peripheral insert in indexable drills, it can be used for most materials and stands out for its operational reliability.
	M15 - M30	■								
	K15 - K35	■								
	S10 - S20	■								
D8345	P30 - P50	■				PVD	Yellow	submicron H	+++	This grade is a universal grade for the central insert in indexable drills, it is an extremely tough suited to most materials.
	M20 - M40	■								
	K30 - K40	■								
	S20 - S30	■								

Substrate

H	WC-Co based substrate
submicron H	WC-Co based substrate fine grained (< 1 μm)
ultra submicron H	WC-Co based substrate very fine grained (< 0,5 μm)
S	Substrate with cubic carbides
FGM	Functionally graded substrate
Cermet	Cemented carbide without WC
ceramics	Cutting ceramics
PCD	Polycrystalline Diamond
CBN	Cubic Boron Nitride
HSS	High speed steel

Coating

MT-CVD	Medium-temperature chemical method of coating
PVD	Low-temperature physical method of coating
-	Uncoated grade

Coolant benefit - Turning

+++	Use of coolant is essential
++	Highly recommended
+	Recommended
+/-	Optional
--	Do not use coolant
-	Coolant not recommended

Coolant benefit - Milling

---	Very negative effect on tool life – cooling is not recommended
-	Slightly negative effect on tool life
+/-	Influence of cooling may be both positive and negative – decisive factor is specific working conditions
++	Positive effect on tool life – cooling is recommended

Coolant benefit - Drilling

+++	Use of coolant is essential
-----	-----------------------------







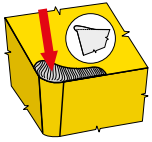
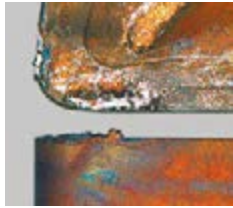

Level of influence

	Level 1 – 5
--	-------------









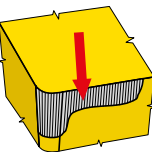

TYPES OF WEAR ON TURNING INSERTS







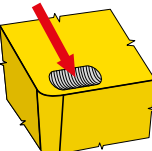

BUILT-UP EDGE

 		It has no influence
		++ Any coating (decisive factor is anti-adhesion effect)
		↑ The higher the feed rate the less probability of built-up edge creation
		↓ ↑ Change (generally increase) the cutting speed
		It has no influence
		↓ ↑ Use more positive geometry (built up edge is not created when the rake angle is more than 40°)
		- Use a coolant with more effective anti-sticking properties (or no coolant at all)

FLANK WEAR

 		↑ Use a more wear resistant substrate (S)
		++ Any coating (decisive factor is oxidation resistance – α Al ₂ O ₃)
		↑ Feed has influence on shape and position of groove
		↓ Decrease cutting speed
		↑ Minimal effect
		+ Use another (more positive) cutting geometry
		+ Use coolant or increase its intensity

CRATERING

 		↑ Use a more wear resistant substrate (S)
		++ Any coating (decisive factor is thermal resistance – α Al ₂ O ₃)
		↑ Feed has influence on shape and position of crater
		↓ Decrease cutting speed
		↓ Minimal effect
		↑ Use more positive cutting geometry
		++ Use coolant or increase its intensity



TYPES OF WEAR ON TURNING INSERTS

OXIDATION GROOVE ON THE MINOR EDGE

		↑	Use a more wear resistant substrate (H)
		++	Any coating (decisive factor is hardness – TIC, TiCN)
		↓	Increase feed (especially if it is under 0.1 mm)
		↓	Decrease cutting speed
		↓	It has no influence
		↑	Increase the clearance angle
		++	Use a coolant or increase its intensity

PLASTIC DEFORMATION

		↑	Use a more wear resistant grade (decisive factor is content of Co)
		+	Any coating (decisive factor is friction)
		↓	Decrease feed rate
		↓	Decrease cutting speed
		↓	Minimal effect
		↑	Use another (more positive) cutting geometry
		++	Use coolant or increase its intensity







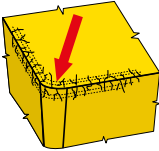

SIDE FLANK NOTCH – REMEDY

		↑ ↓	It depends on the character of the damage (abrasive – use more wear resistant substrate; breaking – use tougher substrate)
		++	CVD coating (decisive factor is oxidation resistance – α Al ₂ O ₃)
		↓	Feed has influence on intensity, but less than the cutting speed
		↓	Decrease cutting speed
		↑ ↓	Use unequal depth of cut
		↓	Use less positive cutting geometry
		+	Use coolant or increase its intensity
			Use tool with smaller setting angle









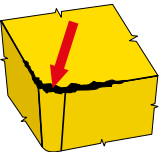
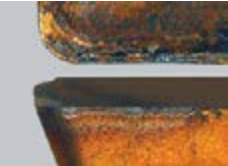

TYPES OF WEAR ON TURNING INSERTS

CREATION OF RACK CRACKS

 		↓ (H) grain has a great influence
		++ PVD coating recommended
		↓ Feed has influence on intensity, but less than the cutting speed
		↓ Lower speed means lower temperature
		It has no influence
		↓ Use less positive cutting geometry
		- - - No coolant (it is possible to use air to remove chips from cutting area)

BRITTLE CRACKS AT THE CUTTING EDGE

 		↓ (H) grain has a great influence
		+ PVD coating recommended
		↓ Good swarf control is very important
		↑ ↓ It is about swarf control and vibration
		↓ Reduces the force load (important for machining with long overhangs)
		↓ Use less positive cutting geometry
		It has no influence
	Use better working conditions, reduce feed rate until insert is in cut	



INSERT FRACTURE

 		↓ (H) grain has a great influence
		+ PVD coating recommended
		↓ Reduces the force load
		↑ ↓ It is about swarf control and vibration
		↓ Reduces the force load
		↓ Use less positive cutting geometry
		It has no influence
	Use better working conditions	

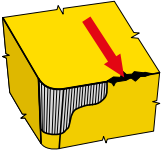

TYPES OF WEAR ON TURNING INSERTS

FAILURE OF CUTTING EDGE

 		↓	(H) grain has a great influence
		+	PVD coating recommended
		↑ ↓	Good swarf control is very important
		↑ ↓	It is about swarf control and vibration
		↑ ↓	Good swarf control is very important
		↓	Use less positive cutting geometry
			It has no influence
			Problem is poor swarf control or evacuation of chips

POOR SURFACE QUALITY



Description and cause:

Numerous causes depending on the workpiece material, cutting conditions (feed rate and cutting speed), the condition of the cutting edge, the extent and type of wear, and the condition and rigidity of the machine–tool–workpiece assembly.

- incorrect tool chosen
- incorrect chip thickness
- incorrect cutting speed
- coolant is needed
- high feed rate

Corrective measures:

- use a wiper insert
- use a cutting insert with the right geometry
- reduce the feed rate
- change (usually increase) the cutting speed
- use a coolant
- improve the stability of the tool and workpiece
- change the chip cross section
- select a more easy–cutting chip breaker
- increase the nose radius

VIBRATIONS



Description and cause:

This is a very common problem, which is mainly caused by an unbalanced workpiece or tool, unstable fixing of the workpiece, high cutting forces or tool overhang.

Corrective measures:

- improve the stability of the tool and workpiece
- reduce the depth of cut
- minimize tool overhang
- reduce the cutting speed
- use a tool with smaller setting angle
- reduce the chip cross section
- use a tool with a low cutting resistance
- increase the feed rate
- select a more easy–cutting chip breaker
- increase the nose radius

BURRS



Description and cause:

This usually occurs on soft steels and plastic materials.

Corrective measures:

- use a cutting insert with a sharp cutting edge
- use a cutting insert with positive geometry
- use a tool with a smaller setting angle

ERRORS IN DIMENSIONS AND SHAPE OF WORKPIECE



Description and cause:
Depends on a number of factors.

- Corrective measures:**
- use a wear-resistant cutting insert
 - improve the stability of the cutter and workpiece
 - minimize tool overhang
 - use a workpiece with a suitable machining allowance

INADEQUATE CHIP FORMATION



Description and cause:
Producing a chip with a suitable shape is very important to insert durability and service life of the tool. The workpiece material, the feed rate, the depth of cut and the cutting geometry all have an effect on chip forming. A chip that is too long is unacceptable for various reasons, while a chip that is too short is undesirable as it overloads the cutting edge and causes vibrations.

- Corrective measures:**
- change the feed rate and depth of cut
 - use a more suitable cutting geometry
 - change the cutting conditions

CHECK THE SEAT CONDITION OF THE CUTTING INSERT

Before clamping a new cutting insert or changing the edge, it is necessary to clean the seat and check its condition or the condition of the anvil and wedge (especially the damage under the corner of the cutting insert).

CHECK AND SERVICE THE CLAMPING PARTS









It is also important to check the clamping parts, including clamping levers, screws, wedges and clamps. Only use original, undamaged parts (found in the catalogue). Regularly lubricate the threads and the binding surface of screws, for example using heat-resistant lubricant (Molykote G.). For assembly and disassembly, only use screwdrivers and wrenches specified in our catalogue or recommended by the tool manufacturer. Pay attention to the correct tightening (proportional) – it is advisable to use a torque wrench.

CHECK THE TIGHTENING









Before tightening, check the fit of the cutting insert on the whole of the binding surface and in the radial and axial directions. Cutting inserts and tools must always be clean and undamaged.

TYPES OF WEAR ON MILLING INSERTS







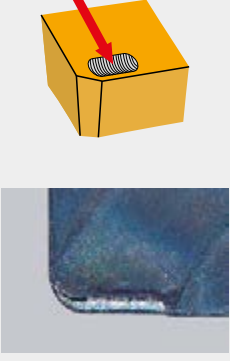

BUILT-UP EDGE

			It has no influence.
		++	Any coating (decisive factor is anti-adhesion effect).
		↑	The higher the feed rate the less probability of built-up edge creation.
		↓↑	Change (generally increase) the cutting speed.
			It has no influence.
		↓↑	Use more positive geometry (built up edge is not created when the rake angle is more than 40°).
		-	Use a coolant with more effective anti-sticking properties (we do not recommend to use coolant for milling).

FLANK WEAR









		↑	Use a more wear resistant substrate (H).
		++	Any coating (decisive factor is hardness – TiC, TiCN).
		↑	Increase feed (especially if it is under 0.1 mm).
		↓	Decrease cutting speed.
			It has no influence.
		↑	Increase the clearance angle.
		+	It can help, but only with ideal working conditions.

CRATERING









		↑	Use a more wear resistant substrate (S).
		++	CVD coating (decisive factor is oxidation resistance – α Al ₂ O ₃).
		↑	Feed has influence on shape and position of crater.
		↓	Decrease cutting speed.
		↓	Minimal effect.
		↑	Use more positive cutting geometry.
		++	It can help, but only with ideal working conditions.

TYPES OF WEAR ON MILLING INSERTS







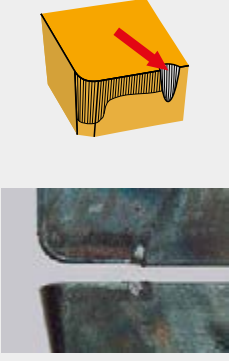

OXIDATION GROOVE ON THE MINOR EDGE

		↑	Use a more wear resistant substrate (S).
		++	CVD coating (decisive factor is oxidation resistance – α Al_2O_3).
		↓	Feed has influence on shape and position of groove.
		↓	Decrease cutting speed.
		↓	Minimal effect.
		↑	Use another (more positive) cutting geometry.
		++	It can help, but only with ideal working conditions.

PLASTIC DEFORMATION

		↑	Using a more wear resistant substrate (decisive factor is content of Co).
		+	Any coating (decisive factor is friction).
		↓	Decrease feed rate.
		↓	Decrease cutting speed.
		↓	Minimal effect.
		↑	Use another (more positive) cutting geometry.
		++	It can help, but only with ideal working conditions.







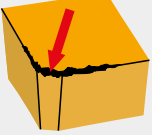

NOTCH WEAR

		↑↓	It depends on the character of the damage (abrasive – use more wear resistant substrate; breaking – use tougher substrate).
		++	CVD coating (decisive factor is oxidation resistance – α Al_2O_3).
		↓	Feed has influence on intensity, but less than the cutting speed.
		↓	Decrease cutting speed.
		↑↓	Use unequal depth of cut.
		↓	Use less positive cutting geometry.
		+	It can help, but only with ideal working conditions.









TYPES OF WEAR ON MILLING INSERTS

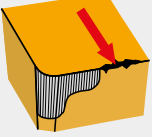





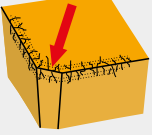

BRITTLE CRACKS AT THE CUTTING EDGE

 		↓	(H) grain has a great influence.
		+	PVD coating recommended.
		↓	Feed has influence on intensity, but less than the cutting speed.
		↑↓	It is about vibrations.
			It has no influence.
		↑	Increase the rake angle to reduce cutting forces.
		-	No coolant (it is possible to use air to remove chips from cutting area).

FAILURE OF CUTTING EDGE







 		↓	(H) grain has a great influence.
		+	PVD coating recommended.
		↑↓	Good swarf control is very important.
		↑↓	It is about swarf control and vibration.
		↑↓	Reduces the force load (important for machining with long overhangs).
		↓	Use less positive cutting geometry.
			It has no influence.

CREATION OF RACK CRACKS

 		↓	(H) grain has a great influence.
		++	PVD coating recommended.
		↓	Feed has influence on intensity, but less than the cutting speed.
		↓	Lower speed means lower temperature.
			It has no influence.
		↑	Use another (more positive) cutting geometry.
		- - -	No coolant (it is possible to use air to remove chips from cutting area).

TYPES OF WEAR ON MILLING INSERTS

INSERT FRACTURE

		↓	(H) grain has a great influence.
		+	PVD coating recommended.
		↓	Very important to reduce cutting force.
		↑↓	It is about swarf control and vibration.
		↓	Reduces the force load.
		↓	Use less positive cutting geometry.
			It has no influence.
			Use better working conditions (a_p / DC).

POOR SURFACE QUALITY

	<p>Description and cause:</p> <p>Numerous causes depending on the workpiece material, cutting conditons (feed rate and cutting speed), the condition of the cutting edge, the extent and type of wear, and the condition and rigidity of the machine – tool – workpiece assembly.</p> <ul style="list-style-type: none"> • Incorrect tool chosen • Incorrect chip thickness • Incorrect cutting speed • Coolant is needed • High feed rate 	<p>Corrective measures:</p> <ul style="list-style-type: none"> • Use a finishing insert, or an insert with finishing segment • Use an insert with suitable cutting geometry • Reduce the feed rate • Adjust (usually increase) the cutting speed • Use coolant or lubrication (MQL) • Eliminate vibrations • Use a tool with which the position of the individual inserts can be adjusted more accurately • Change the chip thickness (modify the machining conditions)
---	--	--

VIBRATIONS

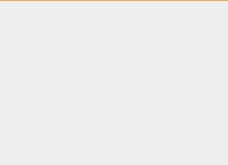
	<p>Description and cause:</p> <p>This is a very common problem, which is mainly caused by an unbalanced workpiece or tool, unstable fixing of the machined part and high cutting forces.</p> <ul style="list-style-type: none"> • Low rigidity of machine-tool-workpiece assembly • Excessive chip depth (both axial and radial) • Run-out – poor workpiece or tool balance • Large tool overhang 	<p>Corrective measures:</p> <ul style="list-style-type: none"> • Check the stability of the workpiece fixing • Check the stability of the tool fixing • Reduce the cutting depth • Use a tool with smaller overhang • Modify the cutting speed • Reduce the chip thickness (change the cutting or machining conditions) • Choose a suitable cutting geometry and tool material to minimize the cutting process force balance (as sharp and as positive as possible), i.e. use a tool with a lower cutting resistance • When milling, use a tool with a smaller setting angle
---	--	---



TYPES OF WEAR ON MILLING INSERTS

BURRS

Description and cause:

This usually occurs on soft steels and plastic materials.

**Corrective measures:**

- Use a cutting insert with a sharp cutting edge
- Use a cutting insert with positive geometry
- Use a tool with a smaller setting angle

ERRORS IN DIMENSIONS AND SHAPE OF WORKPIECE

Description and cause:

Depends on a number of factors.

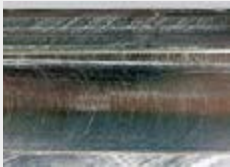
**Corrective measures:**

- Use a wear-resistant cutting insert
- Improve the stability of the cutter and workpiece
- Minimize tool overhang
- Use a workpiece with a suitable machining allowance

INADEQUATE CHIP FORMATION

Description and cause:

Producing a chip with a suitable shape is very important to insert durability and service life of the tool. The workpiece material, the feed rate, the depth of cut and the cutting geometry all have an effect on chip forming. A chip that is too long is unacceptable for various reasons, while a chip that is too short is undesirable as it overloads the cutting edge and causes vibrations.

**Corrective measures:**

- Change the feed rate and depth of cut
- Use a more suitable cutting geometry
- Change the cutting conditions



TYPES OF WEAR ON MILLING INSERTS

CHECK THE SEAT CONDITION OF THE CUTTING INSERT

Before clamping a new cutting insert or changing the edge, it is necessary to clean the seat and check its condition or the condition of the anvil and wedge (especially the damage under the corner of the cutting insert).

CHECK AND SERVICE THE CLAMPING PARTS

It is also important to check the clamping parts, including clamping levers, screws, wedges and clamps. Only use original, undamaged parts (found in the catalogue). Regularly lubricate the threads and the binding surface of screws using, for example, heat-resistant lubricant (MOLYKOTE). For assembly and disassembly, only use screwdrivers and wrenches specified in our catalogue or recommended by the tool manufacturer. Be careful not to over-tighten. To avoid this, we advise using a pre-set torque wrench.

CHECK THE TIGHTENING

Before tightening, check the fit of the cutting insert on the whole of the binding surface and in the radial and axial directions. Cutting inserts and tools must always be clean and undamaged.



TYPES OF TRANSPORT RAILS

TYPE A

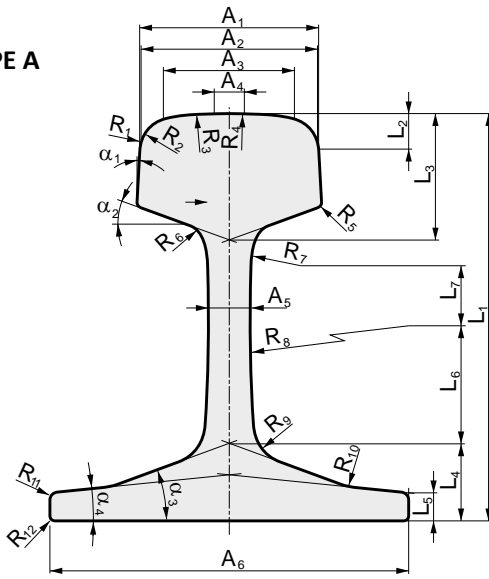

TYPE B

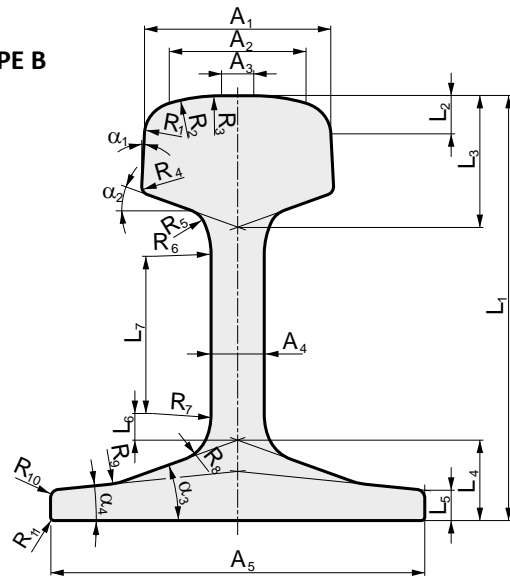

PROFILE	46E1	46E2	46E3	46E4	49E1	49E2	49E5	50E1	50E2	50E3	50E4	50E5	50E6	52E1	54E1	54E2	54E3
Former designation	SBB I	U33	NP 46	46 UNI	DIN 549	S49 T	-	U50E	50EB-T	BV 50	UIC 50	50 UNI	U 50	52 RATP	UIC 54	UIC 54 E	DIN 554
Rail profile type	C	B	C	C	A	A	A	B	B	A	A	A	B	A	A	A	A
A ₁ (mm)	65	62	73.72	65	67	67	67	65	72	70	70	67	65	65	70	67	67
A ₂ (mm)	-	40.588	-	-	-	-	66	43.838	52.053	-	-	-	43.838	-	-	-	-
A ₃ (mm)	43.881	27.946	53.761	-	46.835	-	62.98	30.942	20.456	49.982	49.727	-	30.942	-	49.727	46.31	46.835
A ₄ (mm)	18.881	15	23.015	38.378	15.267	40.471	41.342	15.5	15	18.233	20.025	40.471	15.5	42.456	20.024	18.946	15.267
A ₅ (mm)	16	134	-	16	14	14	14	134	140	14	15	14	140	15	16	16	16
A ₆ (mm)	14	-	14	14	125	125	125	-	-	133	125	135	-	150	140	125	125
A ₇ (mm)	18	-	-	18	-	-	-	-	-	-	-	-	-	-	-	-	-
A ₈ (mm)	125	-	120	135	-	-	-	-	-	-	-	-	-	-	-	-	-
L ₁ (mm)	145	145	142	145	149	148	149	153	151	155	152	148	153	150	159	161	154
L ₂ (mm)	14.3	13.42	14.18	13.75	14	13.62	14.28	13.58	14.3	14.23	14.1	13.62	13.58	-	14.1	13.85	14
L ₃ (mm)	45	47	42.5	45	51.5	50.5	51.5	49	44	48	49.4	50.5	49	55	49.4	51.4	55
L ₄ (mm)	25	27	25	25	27.5	27.5	27.5	28	28	27	28	27.5	28	32	30.2	30.2	29
L ₅ (mm)	-	10.5	-	-	10.5	10.5	10.5	11.5	11.13	10	10	10	11.2	10	11	12	12
L ₆ (mm)	64.45	-	55	52.5	24.5	24.5	24.5	-	10	48	47.1	24.5	-	43	46	46	46
L ₇ (mm)	53.65	-	30	30	30	30	30	-	59	-	18.6	30	-	-	-	-	-
L ₈ (mm)	-	-	-	-	-	-	-	-	-	-	-	-	-	-	-	-	-
L ₉ (mm)	-	-	-	-	-	-	-	-	-	-	-	-	-	-	-	-	-
R ₁ (mm)	13	13	13	14	13	14	7.64	13	13	13	13	14	13	12	13	13	13
R ₂ (mm)	-	60	-	-	-	-	15.5	60	80	-	-	-	60	-	-	-	-
R ₃ (mm)	80	200	80	-	80	-	16.5	200	300	80	80	-	200	-	80	80	80
R ₄ (mm)	300	2	300	400	300	400	115	2	2	300	300	400	2	350	300	300	300
R ₅ (mm)	1	7	1.5	1	2	2	2	12	8	2	3	2	12	5	3	2	5
R ₆ (mm)	6	-	6	5	7	7	7	-	30.81	7	8	7	-	12	8	8	16
R ₇ (mm)	-	-	-	-	80	80	80	-	30.81	-	22	80	-	400	22	22	-
R ₈ (mm)	30	7	80	-	120	120	120	12	8	450	508	120	12	600	508	508	500
R ₉ (mm)	30	20	120	-	-	-	-	20	10	-	-	-	20	-	-	-	-
R ₁₀ (mm)	6	3	6	5	-	-	-	3	5	-	-	-	3	-	-	-	-
R ₁₁ (mm)	2	2	3	2	2	2	2	2	2	2	2	2	2	2	2	2	2
R ₁₂ (mm)	1	-	1	1	-	-	-	-	-	-	-	-	-	-	-	-	-
R ₁₃ (mm)	-	-	-	-	3	3	3	-	-	3	3	3	-	4	3	3	3
R ₁₄ (mm)	-	-	-	-	1.5	1.5	2	-	-	1	2	2	-	3	2	2	2
α ₁ (°)	0°	1:20 2°51'45"	1:16.5 3°28'6"	1:20 2°51'45"	1:17.2 3°19'39"	1:16 3°34'35"	1:17.2 3°19'39"	1:20 2°51'45"	1:20 2°51'45"	1:20 2°51'45"	1:20 2°51'45"	1:16 3°34'35"	1:20 2°51'45"	0°	1:20 2°51'45"	1:20 2°51'45"	1:17.2 3°19'39"
α ₂ (°)	14 14.0362°	13 18°26'06"	14 14°21'0"	14 14°21'0"	13 18°26'06"	13 18°26'06"	13 18°26'06"	13 18°26'06"	13 18°26'06"	13 18°26'06"	13 18°26'06"	12.75 19°58'59"	13 18°26'06"	12 26°33'54"	12.75 19°58'59"	12.75 19°58'59"	13 18°26'06"
α ₃ (°)	14 14.0362°	13 18°26'06"	14 14°21'0"	14 14°21'0"	13 18°26'06"	13 18°26'06"	13 18°26'06"	13 18°26'06"	13 18°26'06"	13 18°26'06"	13 18°26'06"	12.75 19°58'59"	13 18°26'06"	12 26°33'54"	12.75 19°58'59"	12.75 19°58'59"	13 18°26'06"
α ₄ (°)	-	1:10 5°42'38"	-	-	1:7.81 7°17'47"	1:7.81 7°17'47"	1:7.81 7°17'47"	1:10 5°42'38"	1:8 7°7'30"	1:8.31 6°51'42"	1:8.01 7°6'58"	1:8 7°7'30"	1:10 5°42'38"	1:10 5°42'38"	1:10 5°42'38"	1:10 5°42'38"	1:7.81 7°17'47"



TYPES OF TRANSPORT RAILS

TYPE C

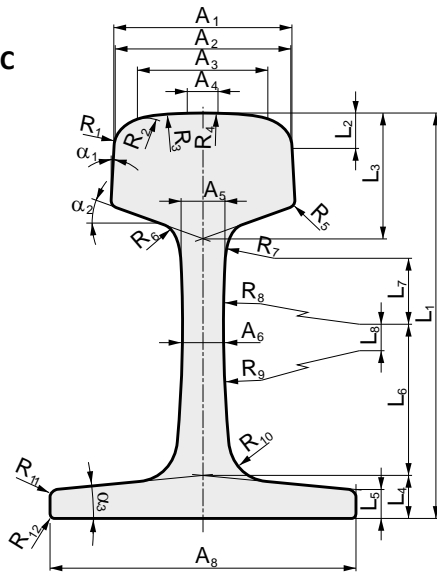

PROFILE	54E4	54E5	55E1	56E1	60E1	60E2	R50	R65	Rail 90ARA-A	Rail 100B	Rail 100RE	Rail 115RE	Rail 119RE	Rail 132RE	Rail 136RE	Rail 141RE
Former designation	-	54E1AHC	U55	BS 113lb BR Variant	UIC 60	-			TR45	100 ARA-B		TR57			TR68	
Rail profile type	A	A	B	B	A	A	C	C	C	C	C	C	C	C	C	C
A ₁ (mm)	67	70.2	62	69.85	72	72	72	73	63	65.0875	65.4456	68.04	66.5	75.17	72.95	74.31
A ₂ (mm)	66	-	40.588	51.235	-	70.774	-	-	-	-	-	61.6	-	-	-	-
A ₃ (mm)	62.98	51.97	27.946	11.787	52.053	48.913	45.7	49.1	45.2	52.8	-	52.6	43.43	65.9	52.75	57.2
A ₄ (mm)	41.342	5.91	19	20	20.456	23.778	20	20	-	31.8	47.6	28	31.2	38.1	35.56	28
A ₅ (mm)	16	16	134	140	16.5	16.5	-	-	-	-	-	-	-	-	-	-
A ₆ (mm)	125	140	-	-	150	150	16	18	14.3	14.3	14.3	15.9	15.9	16.7	17.5	17.5
A ₇ (mm)	-	-	-	-	-	-	-	-	-	-	-	-	-	-	-	-
A ₈ (mm)	-	-	-	-	-	-	132	150	130.2	130.6	136.5	139.7	139.7	152.4	152.4	152.4
L ₁ (mm)	154	159	155	158.75	172	172	152	180	142.9	143.3	152.4	168.3	173	181	185.7	188.9
L ₂ (mm)	14.28	15.4	13.42	14.53	14.3	14.3	15.4	15.67	9.6	7.035	9.71	12.7	14.732	13.06	14.29	15.9
L ₃ (mm)	55	49.4	53	49.21	51	51	42	45	37.3	43.3	42.1	42.9	47.6	44.5	49.2	54.8
L ₄ (mm)	29	30.2	31	30.16	31.5	31.5	27	30	25.4	27.4	27	28.6	28.6	30.2	30.2	30.2
L ₅ (mm)	12	11	14	11.2	11.5	11.5	10.5	11.2	-	-	9.92	11.1	11.1	11.1	11.1	11.2
L ₆ (mm)	46	46	-	-	60.75	60.75	31.5	52.5	48.4	36.3	48.4	53.9	54	68.2	75.82	68.2
L ₇ (mm)	-	-	-	-	19.5	19.5	-	45.1	-	-	-	25	30.39	25.87	21.2	27.33
L ₈ (mm)	-	-	-	-	51.5	51.6	0	0	0	0	0	0	0	0	0	0
L ₉ (mm)	-	-	-	-	32	32	-	-	-	-	-	-	-	-	-	-
R ₁ (mm)	7.64	13	13	12.7	13	8	15	15	9.5	9.5	9.5	9.5	14.3	9.5	14.3	14.3
R ₂ (mm)	15.5	-	60	80	-	16	-	-	-	-	-	14.3	-	-	-	-
R ₃ (mm)	16.5	80	200	305	80	70	80	80	-	38.1	-	44.5	38.1	31.8	31.75	44.5
R ₄ (mm)	115	300	2	3	300	200	500	500	355.6	203.2	355.6	203.2	355.6	254	355.6	203.2
R ₅ (mm)	5	3	12	8	3	3	3	3	1.6	1.6	1.6	1.6	6.4	1.6	7.94	7.94
R ₆ (mm)	16	8	-	-	7	7	10	7	9.5	7.9	9.5	19.05	19.1	8	7.94	7.94
R ₇ (mm)	-	22	-	-	35	35	-	15	-	-	-	76.2	76.2	19.05	19.05	19.05
R ₈ (mm)	500	508	12	15	120	120	325	370	355.6	304.8	355.6	355.6	355.6	203.2	203.2	203.2
R ₉ (mm)	-	-	23	20	120	120	350	400	355.6	304.8	355.6	355.6	355.6	406.4	508	508
R ₁₀ (mm)	-	-	3	3	35	35	20	25	9.5	7.9	15.9	19.05	19.05	22.2	19.05	19.05
R ₁₁ (mm)	2	2	2	1.5	7	7	4	4	1.6	1.6	1.6	1.6	1.6	3.2	3.2	3.2
R ₁₂ (mm)	-	-	-	-	40	40	2	2	1.6	1.6	1.6	1.6	1.6	1.6	1.6	1.6
R ₁₃ (mm)	3	3	-	-	4	4	-	-	-	-	-	-	-	-	-	-
R ₁₄ (mm)	2	2	-	-	2	2	-	-	-	-	-	-	-	-	-	-
alpha ₁ (°)	1:17.2 3°19'39" 3.3274°	1:20 2°51'45" 2.8624°	1:20 2°51'45" 2.8624°	1:20 2°51'45" 2.8624°	1:20 2°51'45" 2.8624°	1:20 2°51'45" 2.8624°	1:20 2°51'45" 2.8624°	1:20 2°51'45" 2.8624°	1:16 3°34'35" 3.5763°	1:19 3°0'46" 3.013°	1:16 3°34'35" 3.5763°	1:40 1°25'56" 1.4321°	1:40 1°25'56" 1.4321°	1:40 1°25'56" 1.4321°	1:40 1°25'56" 1.4321°	1:11.43 5° 5°
alpha ₂ (°)	13 18°26'06" 18.4349°	12.75 19°58'59" 19.983°	13 18°26'06" 18.4349°	12.75 19°58'59" 19.983°	12.75 19°58'59" 19.983°	12.75 19°58'59" 19.983°	14 14°2'10" 14.0362°	14 14°2'10" 14.0362°	14 14°2'10" 14.0362°	14.33 13° 13°	14 14°2'10" 14.0362°	14 14°2'10" 14.0362°	14 14°2'10" 14.0362°	14 14°2'10" 14.0362°	14 14°2'10" 14.0362°	13 18°26'6" 18.4349°
alpha ₃ (°)	13 18°26'06" 18.4349°	12.75 19°58'59" 19.983°	13 18°26'06" 18.4349°	12.75 19°58'59" 19.983°	12.75 19°58'59" 19.983°	12.75 19°58'59" 19.983°	14 14°2'10" 14.0362°	14 14°2'10" 14.0362°	14 14°2'10" 14.0362°	14.33 13° 13°	14 14°2'10" 14.0362°	14 14°2'10" 14.0362°	14 14°2'10" 14.0362°	14 14°2'10" 14.0362°	14 14°2'10" 14.0362°	14 14°2'10" 14.0362°
alpha ₄ (°)	1:7.81 7°17'47" 7.2965°	1:10 5°42'38" 5.711°	1:10 5°42'38" 5.7106°	1:10 5°42'38" 5.7106°	1:14 4°58" 4.0856°	1:14 4°58" 4.0856°	-	-	-	-	-	-	-	-	-	-



RAIL STEEL GRADES

Rail steel grades		Chemical composition (% by mass)											Mechanical properties				
		C	Si	Mn	P	S	Cr	Al	V	Rm (MPa)	Elongation (%)	BHN	Hardness	Centre line			
Specification Grade																	
High speed and mixed traffic																	
UIC 860-0	700	0.40/0.60	0.05/0.35	0.80/1.25	≤ 0.050	≤ 0.050								680/830	≥ 14		
	900A	0.60/0.80	0.10/0.50	0.80/1.30	≤ 0.040	≤ 0.040								880/1030	≥ 10		
	900B	0.55/0.75	0.10/0.50	1.30/1.70	≤ 0.040	≤ 0.040								880/1030	≥ 10		
EN 13674-1	R200	0.40/0.60	0.15/0.58	0.70/1.20	≤ 0.035	0.008/0.035	≤ 0.15	≤ 0.004	≤ 0.03	≤ 0.03	≤ 0.03	≤ 0.03	≤ 0.03	≥ 680	≥ 14		200/240
	R220	0.50/0.60	0.20/0.60	1.00/1.25	≤ 0.025	0.008/0.025	≤ 0.15	≤ 0.004	≤ 0.03	≤ 0.03	≤ 0.03	≤ 0.03	≤ 0.03	≥ 770	≥ 12		220/260
	R260	0.62/0.80	0.15/0.58	0.70/1.20	≤ 0.025	0.008/0.025	≤ 0.15	≤ 0.004	≤ 0.03	≤ 0.03	≤ 0.03	≤ 0.03	≤ 0.03	≥ 880	≥ 10		260/300
	R260Mn	0.55/0.75	0.15/0.60	1.30/1.70	≤ 0.025	0.008/0.025	≤ 0.15	≤ 0.004	≤ 0.03	≤ 0.03	≤ 0.03	≤ 0.03	≤ 0.03	≥ 880	≥ 10		260/300
	R350HT	0.72/0.80	0.15/0.58	0.70/1.20	≤ 0.020	≤ 0.025	≤ 0.15	≤ 0.004	≤ 0.03	≤ 0.03	≤ 0.03	≤ 0.03	≤ 0.03	≥ 1175	≥ 9		350/390
	R350LHT	0.72/0.80	0.15/0.58	0.70/1.20	≤ 0.020	≤ 0.025	≤ 0.30	≤ 0.004	≤ 0.03	≤ 0.03	≤ 0.03	≤ 0.03	≤ 0.03	≥ 1175	≥ 9		350/390
	R370CrHT	0.70/0.82	0.40/1.00	0.70/1.10	≤ 0.020	≤ 0.020	0.40/0.60	≤ 0.004	≤ 0.03	≤ 0.03	≤ 0.03	≤ 0.03	≤ 0.03	≥ 1280	≥ 9		370/410
EN 13674-2	R260Cr	0.40/0.60	0.20/0.45	1.20/1.60	≤ 0.025	≤ 0.025	0.40/0.60	≤ 0.004	≤ 0.06	≤ 0.06	≤ 0.06	≤ 0.06	≤ 0.06	≥ 880	≥ 10		260/300
IRS	880	0.60/0.80	0.10/0.50	0.80/1.30	≤ 0.030	≤ 0.030	-	≤ 0.015	-	-	-	-	-	≥ 880	≥ 10		≥ 260
	1080HH	0.60/0.80	0.10/0.50	0.80/1.30	≤ 0.030	≤ 0.030	-	≤ 0.015	-	-	-	-	-	≥ 1080	≥ 10		340/390

Heavy haul																	
Arema	Standard	0.74/0.86	0.10/0.60	0.75/1.25	≤ 0.020	≤ 0.020	≤ 0.3	≤ 0.01	≤ 0.01	≤ 0.01	≤ 0.01	≤ 0.01	≤ 0.01	≥ 985	≥ 10		≥ 310
	Low alloy standard	0.72/0.82	0.10/0.50	0.80/1.10	≤ 0.020	≤ 0.020	0.25/0.40	≤ 0.005	≤ 0.01	≤ 0.01	≤ 0.01	≤ 0.01	≤ 0.01	≥ 985	≥ 10		≥ 310
	Low alloy intermediate	0.72/0.82	0.10/1.00	0.70/1.25	≤ 0.020	≤ 0.020	0.40/0.70	≤ 0.005	≤ 0.01	≤ 0.01	≤ 0.01	≤ 0.01	≤ 0.01	≥ 1015	≥ 8		≥ 325
	Standard high strength	0.74/0.86	0.10/0.60	0.75/1.25	≤ 0.020	≤ 0.020	≤ 0.3	≤ 0.01	≤ 0.01	≤ 0.01	≤ 0.01	≤ 0.01	≤ 0.01	≥ 1180	≥ 10		≥ 370
	Low alloy high strength	0.72/0.82	0.10/1.00	0.70/1.25	≤ 0.020	≤ 0.020	0.40/0.70	≤ 0.005	≤ 0.01	≤ 0.01	≤ 0.01	≤ 0.01	≤ 0.01	≥ 1180	≥ 10		≥ 370
EN 13674-1	R350HT	0.72/0.80	0.15/0.58	0.70/1.20	≤ 0.020	≤ 0.020	≤ 0.15	≤ 0.004	≤ 0.03	≤ 0.03	≤ 0.03	≤ 0.03	≤ 0.03	≥ 1175	≥ 9		350/390
	R350LHT	0.72/0.80	0.15/0.58	0.70/1.20	≤ 0.020	≤ 0.020	≤ 0.30	≤ 0.004	≤ 0.03	≤ 0.03	≤ 0.03	≤ 0.03	≤ 0.03	≥ 1175	≥ 9		350/390
	R370CrHT	0.70/0.82	0.40/1.00	0.70/1.10	≤ 0.020	≤ 0.020	0.40/0.60	≤ 0.004	≤ 0.03	≤ 0.03	≤ 0.03	≤ 0.03	≤ 0.03	≥ 1280	≥ 9		370/410

Urban transport																	
EN 14811	R200	0.40/0.60	0.15/0.58	0.70/1.20	≤ 0.035	≤ 0.035	≤ 0.15	≤ 0.004	≤ 0.04	≤ 0.04	≤ 0.04	≤ 0.04	≤ 0.04	≥ 680	≥ 14		200/240
	R220G1	0.50/0.65	0.15/0.58	1.00/1.25	≤ 0.025	≤ 0.025	≤ 0.15	≤ 0.004	≤ 0.04	≤ 0.04	≤ 0.04	≤ 0.04	≤ 0.04	≥ 780	≥ 12		220/260
	R260	0.62/0.80	0.15/0.58	0.70/1.20	≤ 0.025	≤ 0.025	≤ 0.15	≤ 0.004	≤ 0.04	≤ 0.04	≤ 0.04	≤ 0.04	≤ 0.04	≥ 880	≥ 10		260/300
Customer	R200V	0.40/0.48	0.15/0.58	0.70/1.10	≤ 0.035	≤ 0.035								≥ 680	≥ 15		200/260
B57865	Conductor Rail	≤ 0.08	≤ 0.05	≤ 0.30	≤ 0.05	≤ 0.05									Resistance < 11.04 μΩ.cm		
Customer	Conductor Rail	0.04/0.06		0.25/0.45	≤ 0.025	≤ 0.020								≥ 300	Resistance < 14 μΩ.cm		
	700V	0.20/0.30	0.20/0.30	1.20/1.50	≤ 0.025	≤ 0.025	≤ 0.10	≤ 0.004	0.10/0.16	0.10/0.16	0.10/0.16	0.10/0.16	0.10/0.16	≥ 685	≥ 14		200/240
	900V	0.41/0.51	0.20/0.30	1.10/1.40	≤ 0.025	≤ 0.025	≤ 0.15	≤ 0.004	0.10/0.15	0.10/0.15	0.10/0.15	0.10/0.15	0.10/0.15	≥ 885	≥ 10		260/300



CALCULATION OF ANGLE 1:X

Incline or gradient is often used to indicate the steepness of a slope which is the magnitude of its incline or slope as compared to the horizontal.

The incline or gradient, is generally described by the 'rise' (**1**) compared with the 'run' (**X**).

Example: 1:20 means that for every 20 millimeters, the height will increase by 1 millimeter.

To calculate the angle of the incline, you can use the mathematical equation:

$$\tan^{-1}\alpha = 1/X$$

Inclination 1:X	α (°)	α (°,';")	$90^\circ - \alpha$ (°)	$90^\circ - \alpha$ (°,';")
1:1.75	29.744	29°44'42"	60.255	60°15'18"
1:2	26.565	26°33'54"	63.435	63°26'6"
1:2.25	23.962	23°57'45"	66.038	66°2'15"
1:2.75	19.983	19°58'59"	70.017	70°1'11"
1:3	18.435	18°26'6"	71.565	71°33'54"
1:4	14.036	14°2'10"	75.964	75°57'50"
1:4.85	11.650	11°39'11"	78.350	78°20'59"
1:5	11.310	11°18'36"	78.690	78°41'24"
1:6	9.462	9°27'44"	80.538	80°32'16"
1:7	8.130	8°7'48"	81.870	81°52'12"
1:8	7.125	7°7'30"	82.875	82°52'30"
1:9	6.340	6°20'25"	83.660	83°39'35"
1:10	5.711	5°42'38"	84.289	84°17'22"
1:11	5.194	5°11'40"	84.806	84°48'20"
1:12	4.764	4°45'49"	85.236	85°14'11"
1:13	4.399	4°23'55"	85.601	85°36'5"
1:14	4.086	4°5'8"	85.914	85°54'52"
1:15	3.814	3°48'51"	86.186	86°11'9"
1:16	3.576	3°34'35"	86.424	86°25'25"
1:17	3.366	3°21'59"	86.634	86°38'11"
1:18	3.180	3°10'47"	86.820	86°49'13"
1:19	3.013	3°0'46"	86.987	86°59'14"
1:20	2.862	2°51'45"	87.138	87°8'15"
1:21	2.726	2°43'35"	87.274	87°16'25"
1:22	2.603	2°36'9"	87.397	87°23'51"
1:23	2.490	2°29'22"	87.510	87°30'38"
1:24	2.386	2°23'9"	87.614	87°36'51"
1:25	2.291	2°17'26"	87.709	87°42'34"
1:40	1.432	1°25'56"	88.568	88°34'5"

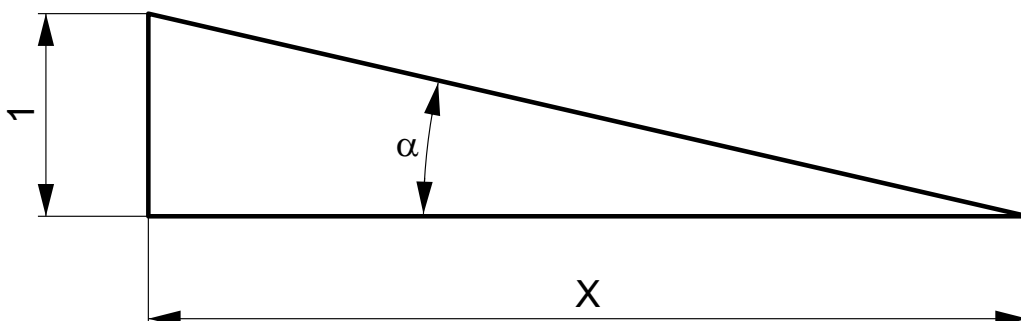



FORMULA FOR CALCULATING CUTTING DATA - TURNING

Value	Formula	Unit	Note
Number of revolutions	$n = \frac{v_c \cdot 1000}{D \cdot p}$	(1/min)	n Number of revolutions (1/min) D Diameter (of tool or workpiece) (mm) v_c Cutting speed (m/min) f_{rev} Feed per revolution (mm/rev) f_{min} Feed per minute (Linear Feedrate) (mm/min)
Cutting speed	$v_c = \frac{p \cdot D \cdot n}{1000}$	(m/min)	
Feed per revolution	$f_{rev} = \frac{f_{min}}{n}$	(mm/rev)	
Feed per minute (Linear Feedrate)	$f_{min} = v_f = f_{rev} \cdot n$	(mm/min)	
Max. height of profile R_{max}	$R_{max} = \frac{125 \cdot f_{rev}^2}{RE}$	(μm)	R_{max} max. height of profile (mm) R_a surface finish (mm) f_{rev} feed per revolution (mm/rev) RE nose radius (mm)
Surface finish R_a	$R_a = \frac{43,9 \cdot f_{rev}^{1,88}}{RE^{0,97}}$	(μm)	
Chip cross section	$A = f_{rev} \cdot a_p$	(mm ²)	A Chip cross section (mm ²) f_{rev} Feed per revolution (mm/rev) a_p Axial depth of cut (mm) κ_r Primary edge setting angle (°) h Chip thickness (mm) v_c Cutting speed (m/min) f_{min} Feed per minute (Linear Feedrate) (mm/min) Q Material removal rate per minute (cm ³ /min) INSD Insert diameter (mm)
Chip thickness (For insert with straight edge)	$h = f_{rev} \cdot \sin \kappa_r$	(mm)	
Chip thickness (For round cutting insert)	$h = f_{rev} \cdot \sqrt{\frac{a_p}{INSD}}$	(mm)	
Metal removal rate	$Q = a_p \cdot f_{rev} \cdot v_c$	(cm ³ /min)	
Power demand	$P_c = \frac{a_p \cdot f_{rev}^{1-c} \cdot k_{c1} \cdot v_c \cdot k_{\kappa_r}}{6 \cdot 10^4 \cdot \eta}$	(kW)	P_c Power demand (kW) a_p Depth of cut (mm) f_{rev} Feed (mm/rev) c Constant KTV (1) k_c Specific cutting force (MPa) k_{κ_r} κ _r angle constant (1) η Efficiency (usually η = 0,75) (1) x Machined material constant (1)
Approximate power demand	$P_c = \frac{a_p \cdot f_{rev} \cdot v_c}{x}$	(kW)	

Material	Steel	Cast iron	Al
Coefficient x	20	25	100



FORMULA FOR CALCULATING CUTTING DATA - MILLING

Value	Unit	Formula
Number of revolutions	(rev/min)	$n = \frac{v_c \times 1000}{DC \times p}$
Cutting speed	(m/min)	$v_c = \frac{p \times DC \times n}{1000}$
Feed per revolution	(mm/rev)	$f_{rev} = \frac{f_{min}}{n} = f_z \times z$
Feed per minute (speed of feed)	(mm/min)	$f_{min} = v_f = f_{rev} \times n = f_z \times z \times n$
Feed per tooth	(mm/tooth)	$f_z = \frac{f_{rev}}{z} = \frac{f_{min}}{n \times z}$
Chip cross section	(mm ²)	$A = f_z \times a_p$
Chip thickness (for inserts with a straight edge)	(mm)	$h = f_z \times \sin KAPR$
Chip thickness (for round cutting inserts)	(mm)	$h = f_z \times \sqrt{\frac{a_p}{INSD}}$
Metal removal rate	(cm ³ /min)	$Q = \frac{a_p \times a_e \times f_{min}}{1000}$
Power demand	(kW)	$P_c = \frac{a_p \times a_e \times f_{min}}{60 \times 10^6 \times h} \times k_c \times k_g$
Approximate power demand	(kW)	$P_c = \frac{a_p \times a_e \times f_{min}}{x}$

Note:

	Quantity	Unit
n	Number of revolutions	(rev/min)
DC	Diameter (of tool or work piece)	(mm)
v_c	Cutting speed	(m/min)
f_{rev}	Feed per revolution	(mm/rev)
A	Chip cross section	(mm ²)
a_p	Axial depth of cut (depth of cut)	(mm)
a_e	Radial depth of cut (width of cut)	(mm)
KAPR	Setting angle	(°)
f_{min}	Feed per minute (sometimes called speed of feed)	(mm/min)
f_z	Feed per tooth	(mm/tooth)
z	Number of teeth	(-)
INSD	Diameter of insert	(mm)

	Quantity	Unit
h	Chip thickness	(mm)
Q	Material removal rate per minute	(cm ³ /min)
P_c	Power demand	(kW)
k_c	Cutting force per mm ²	(MPa)
k_γ	Coefficient of influence of angle γ ₀	(°)
η	Machine efficiency usually η = 0.75	(-)
x	Coefficient of influence of work piece material	(-)

Material	Steel	Cast iron	Al
Coefficient x	24 000	30 000	120 000



HARDNESS TABLE

Hardness and Tensile Strength

HV	HRC	HB	Tensile Strength	
			(N/mm ²)	(Tons/ sq. in.)
940	68	—	—	—
900	67	—	—	—
864	66	—	—	—
829	65	—	—	—
800	64	—	—	—
773	63	—	—	—
745	62	—	—	—
720	61	—	—	—
698	60	—	—	—
675	59	—	—	—
655	58	—	2200	142
650	—	618	2180	141
640	—	608	2145	139
639	57	607	2140	138
630	—	599	2105	136
620	—	589	2070	134
615	56	584	2050	133
610	—	580	2030	131
600	—	570	1995	129
596	55	567	1980	128
590	—	561	1955	126
580	—	551	1920	124
578	54	549	1910	124
570	—	542	1880	122
560	53	532	1845	119
550	—	523	1810	117
544	52	517	1790	116
540	—	513	1775	115
530	—	504	1740	113
527	51	501	1730	112
520	—	494	1700	110
514	50	488	1680	109
510	—	485	1665	108
500	—	475	1630	105
497	49	472	1620	105
490	—	466	1595	103
484	48	460	1570	102
480	—	456	1555	101
473	47	449	1530	99
470	—	447	1520	98
460	—	437	1485	96
458	46	435	1480	96
450	—	428	1455	94
446	45	424	1440	93
440	—	418	1420	92

HV	HRC	HB	Tensile Strength	
			(N/mm ²)	(Tons/ sq. in.)
434	44	413	1400	91
423	43	402	1360	88
413	42	393	1330	86
403	41	383	1300	84
392	40	372	1260	82
382	39	363	1230	80
373	38	354	1200	78
364	37	346	1170	76
355	36	337	1140	74
350	—	333	1125	73
345	35	328	1110	72
340	—	323	1095	71
336	34	319	1080	70
330	—	314	1060	69
327	33	311	1050	68
320	—	304	1030	67
317	32	301	1020	66
310	31	295	995	64
302	30	287	970	63
300	—	285	965	62
295	—	280	950	61
293	29	278	940	61
290	—	276	930	60
287	28	273	920	60
285	—	271	915	59
280	27	266	900	58
275	—	261	880	57
272	26	258	870	56
270	—	257	865	56
268	25	255	860	56
265	—	252	850	55
260	24	247	835	54
255	23	242	820	53
250	22	238	800	52
245	—	233	785	51
243	21	231	780	50
240	—	228	770	50
235	—	223	755	49
230	—	219	740	48
225	—	214	720	47
220	—	209	705	46
215	—	204	690	45
210	—	199	675	44
205	—	195	660	43
200	—	190	640	41



SIMPLY RELIABLE

As a professional you can judge the quality of work by just looking at the chip. Our chip is a clean and uncomplicated shape that in itself tells a story. It is a clear and consistent signal and that's why we use it as a symbol for being **Simply Reliable**.

DORMER PRAMET

Austria

T: +31 (0) 88 304 16 03
info.at@dormerpramet.com

Belgium & Luxembourg

T: +32 3 440 59 01
info.be@dormerpramet.com

Brazil

T: +55 11 5660 3000
info.br@dormerpramet.com

Canada

T: (888) 336 7637
En Français: (888) 368 8457
cs.canada@dormerpramet.com

China

T: +86 21 2416 0508
info.cn@dormerpramet.com

Croatia

T: +385 98 407 489
info.hr@dormerpramet.com

Czech Republic

T: +420 583 381 111
info.cz@dormerpramet.com

Denmark

T: 808 82106
info.se@dormerpramet.com

Finland

T: 0205 44 7003
info.fi@dormerpramet.com

France

T: +33 (0)2 47 62 57 01
info.fr@dormerpramet.com

Germany

T: +49 9131 933 08 70
info.de@dormerpramet.com

Hungary

T: +36-96 / 522-846
info.hu@dormerpramet.com

India

T: +91 11 4601 5686
info.in@dormerpramet.com

Italy

T: +39 02 30 70 54 44
info.it@dormerpramet.com

Kazakhstan

T: +7 771 305 11 45
info.kz@dormerpramet.com

Mexico

T: +52 (555) 7293981
cs.mexico@dormerpramet.com

Netherlands

T: +31 (0) 88 304 16 03
info.nl@dormerpramet.com

Norway

T: 800 10 113
info.se@dormerpramet.com

Poland

T: +48 32 78-15-890
info.pl@dormerpramet.com

Portugal

T: +351 21 424 54 21
info.pt@dormerpramet.com

Romania

T: +4(0)730 015 885
info.ro@dormerpramet.com

Slovakia

T: +421 (41) 764 54 60
info.sk@dormerpramet.com

Slovenia

T: +385 98 407 489
info.si@dormerpramet.com

Spain

T: +34 935717722
info.es@dormerpramet.com

Sweden

responsible for Iceland
T: +46 35 16 52 96
info.se@dormerpramet.com

Switzerland

T: +31 (0) 88 304 16 03
info.ch@dormerpramet.com

Turkey

T: +90 533 212 45 47
info.tr@dormerpramet.com

Ukraine

T: +380 67 566 81 51
info.ua@dormerpramet.com

United Kingdom

responsible for Ireland
T: 0870 850 4466
info.uk@dormerpramet.com

United States of America

T: (800) 877-3745
cs@dormerpramet.com

Other countries

South America

T: +55 11 5660 3000
info.br@dormerpramet.com

Adria

T: +420 583 381 527
info.rcee@dormerpramet.com

Rest of the World

Dormer Pramet International UK
T: +44 1246 571338
info.int@dormerpramet.com

Dormer Pramet International CZ
T: +420 583 381 520
info.int.cz@dormerpramet.com

DP-CAT-RAIL-2022-EN

FOLLOW US...



www.dormerpramet.com



youtube.com/dormerpramet



facebook.com/dormerprametsocial



linkedin.com/company/dormerpramet



instagram.com/dormerprametsocial



twitter.com/dormerpramet